

**BUILD A SOLAR-POWERED BUG ZAPPER!**

JUNE 1996

# Electronics NOW

Build this self-calibrating

## L/C METER

to measure capacitance and inductance

Get in on the ATV action with this miniature

## Amateur TV Downconverter

Stay afloat with our guide to electronic

## Troubleshooting For Boaters

You can add

## Time-Period Cursors

to your oscilloscope with our easy-to-build accessory



A GERNSBACK PUBLICATION

\$3.50 U.S.  
\$3.95 CAN.

#BXNBQWF\*\*\*\*\* 5-DIGIT 87196  
#BRKB4717C96 8#570236 0AP03



JUN 97

CHRIS BARKER

06EN



# True-rms. True values.

**NEW**

Do you troubleshoot non-linear circuits or loads? If so, you need true-rms capability to ensure accurate measurements. Now you can get this capability without having to compromise on quality or safety to stay within your budget.



Priced at just \$199.00\*, the new Fluke Model 76 true-rms DMM is the latest in the long line of true-rms values from Fluke. You can use the Model 76 to easily measure true-rms ac current and volts, dc current and volts, ohms, capacitance, continuity, and frequency. And, the Model 76 is the only DMM in its class that meets UL, CE, CSA, and TÜV certification standards and conforms to the IEC 1010-1 product safety standard for Overvoltage Category III.<sup>(1)</sup>

You'll find that kind of true value all the way down the line with Fluke test tools. See your local Fluke distributor to select a true-rms meter that fits whatever your job or budget demands.



Fluke 32  
\$149\*



Fluke 33  
\$269\*



Fluke 76  
\$199\*



Fluke 87  
\$335\*



Fluke 8060A  
\$459\*

\* U.S. list price. Prices subject to change without notice.

(1) Approvals/Listing pending

© 1995 Fluke Corporation P. O. Box 9090, M/S 250E, Everett, WA USA 98206-9090. U.S. (206) 356-5400. Canada (905) 890-7600. Europe (31 40) 644200. Other countries (206) 356-5500. All rights reserved. Ad no. 00768

CIRCLE 121 ON FREE INFORMATION CARD



**FLUKE**

www.americanradiohistory.com

# What's better than speed reading? *Speed Learning.*

Speed Learning has replaced speed reading. It's a whole new way to read and learn. It's easy to learn...lasts a lifetime... applies to everything you read. It may be the most productive course you've ever taken.

Do you have too much to read and too little time to read it? Do you mentally pronounce each word as you read? Do you frequently have to go back and reread words, or whole paragraphs, you just finished reading? Do you have trouble concentrating? Do you quickly forget most of what you read?

If you answer "Yes" to any of these questions — then here at last is the practical help you've been waiting for. Whether you read for business or pleasure, school or college, you will build exceptional skills from this major breakthrough in effective reading, created by Dr. Russell Stauffer at the University of Delaware.

**Not just "speed reading" — but speed reading — thinking — understanding — remembering — and — learning**

The new *Speed Learning Program* shows you, step-by-proven step, how to increase your reading skill and speed, so you understand more, remember more and use more of everything you read. The typical remark from over one million people taking the Speed Learning program is, "Why didn't someone teach me this a long time ago." They were no longer held back by their lack of skills and poor reading habits. They could read almost as fast as they could think.

## What makes Speed Learning so successful?

The new *Speed Learning Program* does not offer you a rehash of the usual eye-exercises, timing devices, and costly gadgets you've probably heard about in connection with speed reading courses, or even tried and found ineffective.

In just a few spare minutes a day of easy reading and exciting listening, you discover an entirely new way to read and think — a radical departure from anything you have ever seen or heard about. Speed Learning is the largest selling self-study reading program in the world. Successful with Fortune 500 corporations, colleges, government agencies and accredited by 18 professional societies. Research shows that reading is 95% *thinking* and only 5% eye movement. Yet most of today's speed reading programs spend their time teaching you rapid eye movement (5% of the problem), and ignore the most important part, (95%) *thinking*. In brief, *Speed Learning gives you what speed reading can't.*

Imagine the new freedom you'll have when you learn how to dash through all types of reading material at least twice as fast as you do now, and with greater comprehension. Think of being able to get on top of the avalanche of newspapers, magazines and correspondence you have to read...finishing a stimulating book and retaining facts and details



**FOR FASTER SHIPMENT CALL 1-800-729-7323 OR FAX 1-609-273-7766**

more clearly, and with greater accuracy, than ever before.

## Listen — and learn — at your own pace

This is a practical, easy-to-learn program that will work for you — no matter how slow a reader you think you are now. The *Speed Learning Program* is scientifically planned to get you started quickly...to help you in spare minutes a day. It brings you a "teacher-on-cassettes" who guides you, instructs, and encourages, explaining material as you read. Interesting items taken from *Time Magazine*, *Business Week*, *Wall Street Journal*, *Money*, *Reader's Digest*, *N.Y. Times* and many others, make the program stimulating, easy and fun...and so much more effective.

Executives, students, professional people, men and women in all walks of life from 15 to 70 have benefitted from this program. Speed Learning is a fully accredited course...costing only 1/4 the price of less effective speed reading classroom courses. Now you can examine the same easy, practical and proven methods at home...in your spare time...without risking a penny.

## Examine Speed Learning RISK FREE for 15 days

You will be thrilled at how quickly this program will begin to develop new thinking and reading skills. After listening to just one cassette and reading the preface, you will quickly see how you can achieve increases in both the speed at which you read, and in the amount you understand and remember.

You must be delighted with what you see, or you pay nothing. Examine this remark-

able program for 15 days. If, at the end of that time you are not convinced that you would like to master Speed Learning, simply return the program for a prompt refund. (See the coupon for low price and convenient credit terms.)

## RISK-FREE ORDER FORM

**YES!** I want to try Speed Learning for 15 days without risk. Enclosed is the first of 4 monthly payments of \$32.25\*. If I'm not completely satisfied, I may return it for a prompt refund.

**SAVE 8.00!** I prefer to pay the \$129.00 now, and save the \$8.00 shipping & handling charge. I may still return the program for a full refund.

**Method of payment:** (Federal Tax Deductible)

Check or money order payable to Learn Incorporated

Charge to:  Visa  MC  Am Ex  Discover

Card # \_\_\_\_\_ Exp. \_\_\_\_\_

Signature \_\_\_\_\_

Phone (\_\_\_\_\_) \_\_\_\_\_

Name \_\_\_\_\_

Address \_\_\_\_\_

City \_\_\_\_\_ State \_\_\_\_\_ Zip \_\_\_\_\_

\*Plus \$8.00 shipping and handling. U.S. funds only. For New Jersey residents, sales tax will be added.

**learn**  
INCORPORATED

Dept. LEC-01, 113 Gaither Drive,  
Mt. Laurel, NJ 08054-9987

# CONTENTS

JUNE 1996

**ON THE COVER**

**31 L/C METER**

From communications engineers and technicians to hobbyists working on oscillator projects, an L/C meter can come in mighty handy. This meter is an update of a design first presented in this magazine in 1988. This new version features several improvements. First,

it is based on a microcontroller that helps to make its construction extremely easy. It also allows the meter to be built on a smaller, single-sided circuit board. The display can show the units of measurements as well as the numeric value. Best of all, the L/C meter is self-calibrating, which ensures that you'll be able to rely on its measurements. — *Neil Heckt*



**BUILD THIS**

**33 BUILD THIS UHF DOWNCONVERTER**

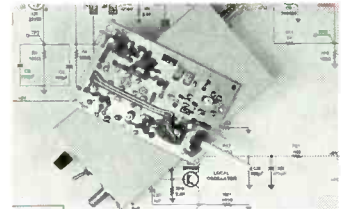

You can pull in ATV transmissions on the 900 or 1300 MHz amateur television band and display them on a standard TV with this miniature project. — *William Sheets and Rudolf F. Graf*

**39 SOLAR-POWERED FLY CONTROLLER**

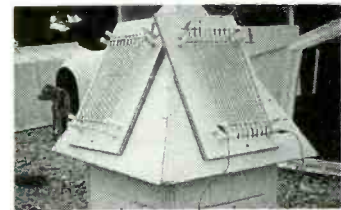

This budget project, ideal for remote areas, zaps house flies and other flying insects with a miniature bolt of lightning! — *Lawrence Pickens*

As a service to readers, ELECTRONICS NOW publishes available plans or information relating to newsworthy products, techniques and scientific and technological developments. Because of possible variances in the quality and condition of materials and workmanship used by readers, ELECTRONICS NOW disclaims any responsibility for the safe and proper functioning of reader-built projects based upon or from plans or information published in this magazine.

Since some of the equipment and circuitry in ELECTRONICS NOW may relate to or be covered by U.S. patents, ELECTRONICS NOW disclaims any liability for the infringement of such patents by the making, using, or selling of any such equipment or circuitry, and suggests that anyone interested in such projects consult a patent attorney.

ELECTRONICS NOW, (ISSN 1067-9294) June 1996. Published monthly by Gernsback Publications, Inc., 500 Bi-County Boulevard, Farmingdale, NY 11735-3931. Second-Class Postage paid at Farmingdale, NY and additional mailing offices. Canada Post IPM Agreement No. 334103, authorized at Mississauga, Canada. One-year subscription rate U.S.A. and possessions \$19.97, Canada \$27.79 (includes G.S.T. Canadian Goods and Services Tax, Registration No. R125166280), all other countries \$28.97. All subscription orders payable in U.S.A. funds only, via international postal money order or check drawn on a U.S.A. bank. Single copies \$3.50. © 1996 by Gernsback Publications, Inc. All rights reserved. Printed in U.S.A.

POSTMASTER: Please send address changes to ELECTRONICS NOW, Subscription Dept., Box 55115, Boulder, CO 80321-5115.

A stamped self-address envelope must accompany all submitted manuscripts and/or artwork or photographs if their return is desired should they be rejected. We disclaim any responsibility for the loss or damage of manuscripts and/or artwork or photographs while in our possession or otherwise.

**TECHNOLOGY**

**41 TROUBLESHOOTING FOR BOATERS**  
 Safety comes first, but it goes hand-in-hand with electrical maintenance to safeguard you and your boat on the high seas.  
 — Vaughn D. Martin

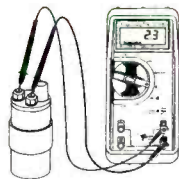

**43 DUAL SCOPE ADAPTER**  
 Add time-period cursors and delayed sweep to your oscilloscope with this handy, precision adapter.  
 — Skip Campisi



**DEPARTMENTS**

**6 VIDEO NEWS**  
 What's new in this fast-changing industry. — Dave Lachenbruch

**14 EQUIPMENT REPORTS**  
 Staticide Laser Printer Cleaning Paper

**27 COMPUTER CONNECTIONS**  
 Cross-platform networking can be a bumpy ride.  
 — Jeff Holtzman

**43 HARDWARE HACKER**  
 The new meaning of power-factor correction, your own web site, and more. — Don Lancaster

**51 LASER EXPERIMENTS**  
 Modulating laser light.  
 — Carl J. Bergquist

**57 SERVICING**  
 Making voltage measurements with a DSO. — Ed Caryl



**AND MORE**

**4 WHAT'S NEWS**  
**9 Q&A**  
**10 LETTERS**  
**16 NEW PRODUCTS**

**24 NEW LITERATURE**  
**126 ADVERTISING SALES OFFICES**  
**126 ADVERTISING INDEX**

**Electronics NOW®**

Hugo Gernsback (1884-1967) founder

**LARRY STECKLER, EHF, CET,**  
 Editor-in-chief and publisher

**EDITORIAL DEPARTMENT**  
**BRIAN C. FENTON,** editor  
**JULIAN S. MARTIN,** associate editor  
**TERI SCADUTO,** assistant editor  
**JEFFREY K. HOLTZMAN**  
 computer editor  
**LARRY KLEIN,** audio editor  
**DAVID LACHENBRUCH**  
 contributing editor  
**DON LANCASTER**  
 contributing editor  
**MICHAEL A. COVINGTON, N4TMI**  
 contributing editor  
**EVELYN ROSE,** editorial assistant

**ART DEPARTMENT**  
**ANDRE DUZANT,** art director  
**RUSSELL C. TRUELSON,** illustrator

**PRODUCTION DEPARTMENT**  
**RUBY M. YEE,** production director  
**KATHRYN R. CAMPBELL**  
 production assistant  
**KEN COREN**  
 desktop production

**CIRCULATION DEPARTMENT**  
**JACQUELINE P. CHEESEBORO**  
 circulation director  
**THERESA LOMBARDO**  
 circulation assistant

**REPRINT DEPARTMENT**  
**MICHELE TORRILLO**  
 reprint bookstore

Typography by Mates Graphics  
 Cover design by David Loewy

**Electronics Now** is indexed in *Applied Science & Technology Index*, and *Readers Guide to Periodical Literature*, *Academic Abstracts*, and *Magazine Article Summaries*.

Microfilm & Microfiche editions are available. Contact reprint bookstore for details.

**Advertising Sales Offices listed on page 126.**

Electronics Now Executive and Administrative Offices  
**1-516-293-3000.**

Subscriber Customer Service:  
**1-800-288-0652.**

Order Entry for New Subscribers:  
**1-800-999-7139.**



Audit Bureau of Circulations  
 Member



# WHAT'S NEWS

A REVIEW OF THE LATEST HAPPENINGS IN ELECTRONICS

## Molecules moved and positioned at room temperature

For the first time, scientists at IBM's Zurich Research Laboratory have succeeded in moving and precisely positioning individual molecules at room temperature. The procedure, which is viewed as an important step toward being able to do a wide range of "engineering" on the nanometer scale, was accomplished using the extremely fine tip of a scanning tunneling microscope (STM). It could help take miniaturization to its limits, and pave the way to fabricating molecules with specific properties and functions, building ultra-small computers, and even constructing tiny molecular machines that would be capable of, for instance, cleaning or repairing nano-scale electronic circuits.

The scanning tunneling microscope, which was invented at IBM's Zurich Research Laboratory and whose inventors were granted a Nobel Prize in Physics in 1986, plays a major role in the creation of such a "nanocosmos." The STM can be used not only for imaging surfaces with atomic resolution, but also for positioning individual atoms and molecules.

There were some problems to overcome, however. Most atoms and molecules stick to the surface and to the STM tip, making it difficult to pick them up and release them in a precisely controlled way. Those that are less "sticky" tend to jitter and jump around at room temperature. Although the jitter problem can be overcome by cooling the sample to near absolute zero

(as proven in 1989 by scientists at IBM's Almaden Research Center in San Jose), room-temperature positioning is required for broad practical uses, such as creating chemical reactions that build functional units from individual atoms and molecules. In 1991, scientists at IBM's T.J. Watson Research Center in Yorktown Heights, New York, used electrical pulses to pick up and release individual silicon atoms at room temperature. However, the strong electrical pulses required by that technique tore apart most molecules.

Now IBM scientists in Zurich have succeeded in positioning individual molecules at room temperature using purely mechanical means. For the mechanical method to work, the molecules must stick tightly enough to remain at their position but not so tightly that they

cannot be moved. The chemical bonds within the molecule, on the other hand, must resist being changed or broken when the molecule is pushed by the tip of the STM.

After studying several possible molecules, the scientists selected Cu-tetra-(3,5 di-tertiary-butylphenyl)-porphyrin (Cu-TBP-porphyrin), an organic molecule that has a total of 173 atoms. At its core is a stable ring or atoms known as a phophyrin. Four strongly but flexibly bonded hydrocarbon groups attached vertically to the ring to make the molecule, which has a diameter of approximately 1.5 nanometers. Cu-TBP-porphyrin is ideal for displacement experiments: Its position and structure are easily identified by STM imaging, and the four hydrocarbon groups act as

*continued on page 12*

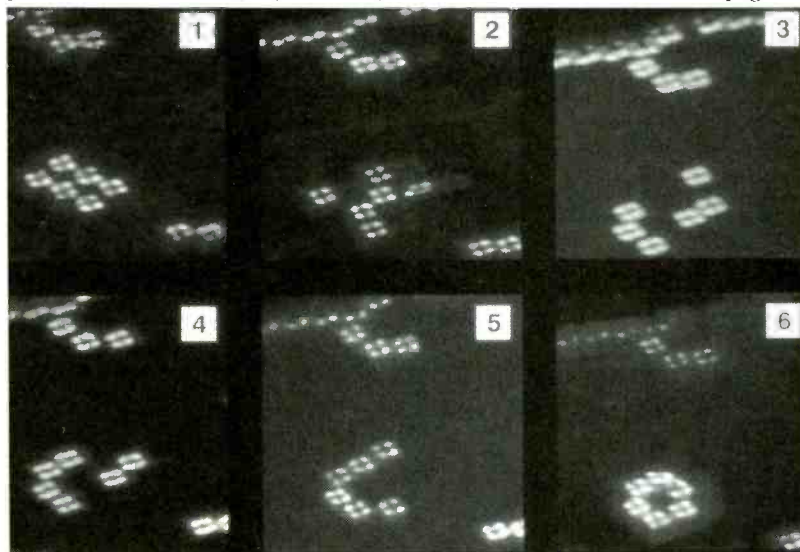

This sequence of images illustrates the manipulation of individual molecules. A group of six molecules (1) is first disordered (2) by cruising through the group with the scanning tunneling microscope (STM) tip. Subsequently, one molecule after the other is pushed by the tip in a precisely controlled manner (3-5). That allows a ring, which would not normally be found in nature, to be formed (6). Note that the process does not interfere with the other molecules visible at the top of the images; their positions remain unchanged.

# Just a reminder.

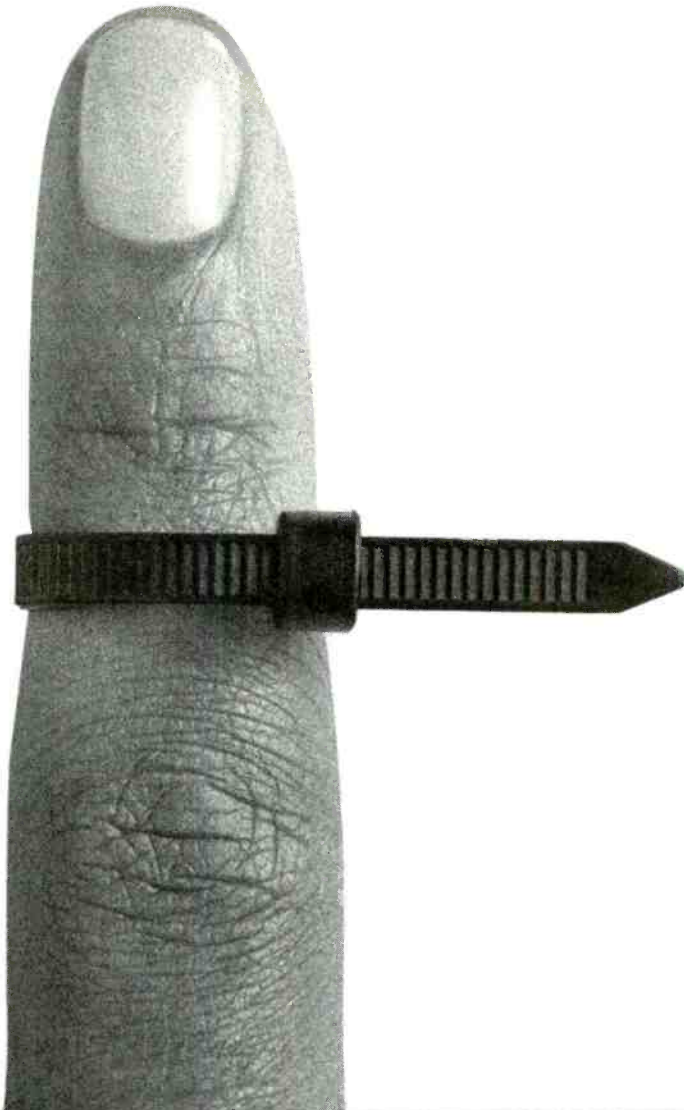

## We even have the bits and pieces to organize your bits and pieces.

**A**dding a phone? Hooking up a home theater system? Putting up an antenna or satellite dish? You don't need the mess of twisting, trailing wires and cables. When neatness counts, you need flexible split tubing to bundle wires, nylon cord ties, beaded wire ties, wall-feedthrough bushings, adhesive clips or wire staples. And you'll find it all at your nearby RadioShack. We've got the products, the parts and the people to help you put it all together. For a store near you, call 1-800-THE-SHACK.

 **RadioShack**<sup>SM</sup>  
You've got questions.  
We've got answers.<sup>®</sup>



# VIDEO NEWS

WHAT'S NEW IN THE FAST-CHANGING VIDEO INDUSTRY

BY DAVID LACHENBRUCH

## The satellite boom

Video's big story of 1996 may well turn out to be direct broadcasting via satellite (DBS). After years of forecasts and failures, DBS has finally taken off via high-powered satellites that require only a small home dish, 18 inches in diameter. The two major broadcast services, DirecTV and U.S. Satellite Broadcasting—both of which deliver many of the same channels carried by cable and have plans to increase their offerings to 150 or so channels—are sharing their success with Thomson Consumer Electronics, whose RCA-brand Digital Satellite System (DSS) receivers boomed last year to sales of one million.

Now other receiver makers are getting into the act. Sony was the second, but before the year is out there could be a dozen brands vying for the receiver market, along with new satellite systems to rival DSS. Following Sony came Toshiba and Uniden, with Philips (Magnavox), Hughes Communications, and even AT&T expected to offer receivers.

At the same time, new DBS broadcasters EchoStar and AlphaStar are beginning to offer programming from their own satellite. And Primestar—originally established by cable-TV operators as a defensive measure against satellite—now appears ready to become an important venture on its own. AlphaStar receivers will be sold through direct-marketing Amway distributors.

TV isn't the only thing distributed by these new DBS satellites. They all offer a wide variety of "CD-quality" music programs. DirecTV is planning to offer a new

service called DirecPC to bring on-line programming to computers, and Microsoft also will join the DSS system with a service to feed computers via satellite.

## PlayStation the winner

In the hotly competitive video-game business, an upstart newcomer has bumped Nintendo and Sega from their traditional lead position, and virtually forced two other rivals out of the field completely. Sony is an upstart because, for all of its electronics experience, it's new to the video-game business. But its PlayStation was an immediate suc-

cess in Japan, the U.S., and Europe, and the demand is still higher than the availability of game consoles and software. More than one million PlayStations have been sold in this country since it was introduced in September 1995, and Sony is expecting to sell as many as 3 million consoles next year.

Sega's Saturn has proved to be a disappointment, with sales estimated at only 400,000 in the U.S. last year. Nintendo, which has been widely touting its upcoming 64-bit N64 model, has repeatedly failed to meet its introductory deadlines. Its fall 1995 introduction date was postponed to April 1996, and that



Sony's SAS-AD1 is the second brand OF DIGITAL SATELLITE SYSTEM to enter the fast-growing DSS market; Toshiba and Uniden came next, with Philips, AT&T, and several more companies to follow suit by year's end.



Special Prices for Electronics Now Readers. Please mention VIP #6R6!

Call for your FREE catalog!

# Your One Stop Component & Computer Source

## JAMECO Electronic Kits Digital Clock Kit



Jameco introduces a digital clock kit ideal for home or business use. The clock may be placed on a flat surface or wall mounted.

- Bright 2.5" high 6-digit displays (red)
- Can be viewed from over 50' away
- 12 hour or 24 hour display switch
- Fast and slow set switches
- Time hold control switch
- Safe low input voltage: 12VAC
- 105507 kit includes: PC board, components, wall transformer and kit instructions - 183 total pieces (case with red lens sold separately)
- Assembled kit available - call for info.
- Kit PC board size: 17.5"L x 3.5"W
- Weight: 1.0 lb.

Part No.	Description	1-4	5-9
105507	Digital clock kit	SALE	\$49.95

## Fiber Optics Kit

Use light to transmit and receive information. Discover the intriguing principles of fiber optics data communications. The kit includes separate transmitter and receiver circuit boards, fiber optics cable and all connectors for interfacing cables with the circuit boards. Either a square-wave or TTL signal from 200Hz to 5kHz can be inputted.

- Requires 9 volt battery (not included)
- Size: 4.1"L x 1.5"W x 0.3"H
- Weight: 0.1 lbs.



Part No.	Description	1-4	5-9
21135	Fiber optics kit	SALE	\$19.95 \$17.95

## Function Generator Kit

Sine, triangle and square wave. Great for prototyping electronic circuits, whether analog or digital! Produces sinusoidal, triangular (saw-tooth), and square wave-forms at frequencies continuously variable from 1Hz to 100kHz. Requires 12VDC supply or ±6VDC split supply.

- 21 piece kit (chip, components, PC board, hardware)
- Recomd. power supply P/N 20626 - below
- Size: 4.1"L x 1.5"W • Weight: 0.2 lbs.



Part No.	Description	1-4	5-9
20685	Function gen.	SALE	\$19.95 \$17.95

## Dual Adjustable Power Supply Kit

±5VDC to ±15VDC @ 175mA to 750mA

- 48 piece kit (components/hardware)
- Adjustable positive & negative supplies ±5 to ±15VDC regulated, 175mA - 750mA per supply
- Positive and negative 5VDC to 15VDC
- Power output (each supply): 5VDC @ 750mA, 12VDC @ 500mA, and 15VDC @ 175mA
- 120VAC input • LED on indicator
- PC board construction
- Includes easy to follow instructions
- Size: 5.1"L x 3.5"W x 2.0"H
- Weight: 1.8 lbs.



Part No.	Description	1-4	5-9
20626	Power supply kit.	SALE	\$19.95 \$17.95

## PRECISION NAVIGATION, INC. Vector 2X Compass Module

- Applications: vehicle mapping and tracking, robotics, HAM radios, camera positioning
- 2" accuracy, 1" resolution
- 3-wire serial output format (compatible with Motorola SPI and National Microwire)
- Pin selectable BCD or binary output format
- Power supply: single 5 volt
- Size: 1.5"L x 1.3"W x 0.4"H • Weight: 0.1 lbs.



## PRECISION NAVIGATION, INC. Vector 2X Developers Kit

- Development board which allows your Vector 2X to directly communicate via the parallel port of your PC
- Weight: 0.8 lbs.

Part No.	Description	1-4	5-9
126691	Vector 2X kit	SALE	\$99.95 \$89.95

## METEX Jumbo Digital Multimeter

0.7" High Digits 4 1/2-Digit LCD

- Data hold switch
- Measures: AC/DC voltage, AC current (2mA to 20A), DC current (200mA to 20A), resistance, diodes, transistor HFE, audible continuity test, frequency and capacitance
- Auto-zeroing • Sturdy case
- Input impedance: 10MΩ
- Overload protection: 1000VAC/VDC
- Includes probes, batteries, carrying case and manual
- Size: 3.5"W x 1.5"D x 7.0"H
- Weight: 1.5 lbs. • One-year warranty



Part No.	Description	1-4	5-9
27158	4 1/2-digit meter	SALE	\$89.95

## Jameco 26 pc. Hobby Tool Set

- 6 screw-drivers (Phillips #0, #1, slotted 0.05", 0.08", 0.09", 0.12")
- Handle
- 10 bits: 5, 6mm, #No.1, #No.2, No.1, No.2, T-10, T-15, T-20, socket adapter
- Stainless tweezers
- Extension bar • Sockets: 5, 6, 8, 10mm
- 4" long nose plier • 4" side cutter
- Plastic carrying case • Weight: 1.3 lbs.



Part No.	Description	Price
99629	26 pc. tool set	SALE \$17.95

## 20MHz Digital Storage Oscilloscope



The OS-3000-RS is a two channel scope providing storage capability through your RS232 port using the provided program. It combines the benefits of both a digital and analog scope.

- Input: 100-240VAC @ 50/60Hz
- 20MHz/sec. maximum sample rate
- 2000 words per channel memory

Part No.	Description	Price
129365	20MHz scope	SALE \$1029.95

## Jameco 16-Bit Sound Card

- 386/486/Pentium® and compatibles
- Input, line in, CD audio, music synthesis and mic.
- IDE CD-ROM interface
- Compatible with SoundBlaster Pro, Sound Blaster and Ad-lib sound systems



Part No.	Description	1-4	5-9
129681	16-bit snd. card	SALE	\$69.95 \$62.95

## Linear Integrated Circuits

Part No.	Product No.	1-9	10-99
23051	LH0002CN	SALE \$7.95	\$6.95
27852	OP07	SALE 1.95	1.75
24811	MAX232CPE	SALE 1.95	
23579	LM317T	SALE .59	
23683	LM324N	SALE .39	.35
23721	LM331N	SALE 3.95	3.49
23771	LM336Z	SALE .79	
23851	LM339N	SALE .39	
23966	LM358N	SALE .45	.39
24061	LM381N	SALE 6.95	6.25
24109	LM385Z	SALE 1.29	1.19
24117	LM385Z1.2	SALE 1.19	1.09
24133	LM386N-3	SALE .89	.79
24301	LM399H	SALE 4.49	3.95
27422	NE555V	SALE .35	.29
24328	LM556N	SALE .49	.45
24352	LM565N	SALE 1.49	1.35
24539	LM741CN	SALE .35	.29
23157	LM1488N	SALE .45	.39
23181	LM1489N	SALE .45	.39
34972	XR2206	SALE 3.49	3.19
39600	26LS32	SALE .89	.79
23341	LM2917N-14	SALE 1.49	1.29
24230	LM3914N	SALE 2.09	1.95
27385	NE5532	SALE .89	.79
51182	78L05	SALE .29	.25
51246	7805K	SALE 1.89	1.69
51262	7805T	SALE .39	
51334	7812T	SALE .45	.39
25064	MC14490P	SALE 4.25	3.95
50964	75176	SALE 1.19	1.09
25099	MC145406P	SALE 1.95	1.75

## Leap 512K-Two Socket (E)EPROM Programmer SPECIAL

The Leaper-3 is a compact unit that operates in two modes: "Stand alone mode," which allows you to use it as a portable unit or in



"Remote control mode," which uses software to interface with your RS232 port.

- Programs EPROMs up to 25V, Flash EPROMs 5V & 12V, EEPROMs, and SRAMs
- 2 socket for master/slave operation
- For stand alone mode use 1-2 (9V) batteries (not incl.) or 9VDC adapter (incl.)
- Includes manual, cable, and 3.5" disk
- Size: 6.4"L x 4.3"W x 2.2"H • Weight: 2 lbs.

Part No.	Description	Price
130155	EPROM writer	SALE \$279.95

## Encyclopedia of Electronic Circuits SPECIAL

TAB Publishing: This collection of books, each containing unique circuit applications, has over 100 chapter categories of circuits. Includes alphabetical index and descriptions.



Volume 1: (1985) contains smoke and flame detectors, voltage circuits, transmitters, audio amps, and more. (795 pages)

- Size: 7.4" x 9.3" • Weight: 3.0 lbs.

Part No.	Description	Price
126181	Encyclopedia Vol. 1	SALE \$26.95

Volume 2: (1988) contains current and DIP meters, photoelectric alarms, electronic locks, metal and lie detectors. (755 pages)

- Size: 7.4" x 9.3" • Weight: 2.8 lbs.

Part No.	Description	Price
128881	Encyclopedia Vol. 2	SALE 26.95

Volume 3: (1991) contains new easy alarms, lamp control circuits, multiplexers, oscilloscope circuits, laser and fiber-optic circuits. (850 pages)

- Size: 7.4" x 9.3" • Weight: 3.1 lbs.

Part No.	Description	Price
128872	Encyclopedia Vol. 3	SALE 26.95

Volume 4: (1992) contains new automotive and game circuits, power supplies, microwave amp circuits, active antennas, video, and computers. (730 pages)

- Size: 7.4" x 9.3" • Weight: 2.7 lbs.

Part No.	Description	Price
128899	Encyclopedia Vol. 4	SALE 26.95

Volume 5: (1995) contains new easy circuits including: alarms and security, computers, frequency meters, gas and smoke detectors, video amps, temp sensors and much more! (730 pages)

- Size: 7.4" x 9.3" • Weight: 2.7 lbs.

Part No.	Description	Price
119896	Encyclopedia Vol. 5	SALE 29.95

## 80C52-Basic Microcontroller

The 80C52-Basic chip is a custom-masked 80C52 microcontroller with a full-featured 8K-byte ROM-resident Basic-52 interpreter.

Hardware:

- Operates DC to 12MHz
- On-chip oscillator and clock circuit
- 256 x 8-bit RAM



Software:

- Full BASIC interpreter in ROM on a single chip 125647
- "Stand-alone" software development
- Interrupts can be handled by BASIC or Assembly Language

Part No.	Description	1-9	10-49
125647	CPU 8-bit CMOS	SALE \$19.95	\$17.95
126375	Microcontr. Idea Book	SALE	31.95
126252	Basic-52 Progr. Ref.	SALE	21.95 19.95
126295	Basic-52 3.5" Disk	SALE	11.95 10.49

## JAMECO ELECTRONIC COMPONENTS COMPUTER PRODUCTS

© 1996 Jameco 6/96  
New Hours:  
6AM - 6PM PST

1355 Shoreway Road Belmont, CA 94002-4100  
FAX: 1-800-237-6948 (Domestic)  
FAX: 415-592-2503 (International)  
E-mail: info@jameco.com  
http://www.jameco.com



Mention V.I.P. # 6R6

Call 1-800-831-4242 to order today!

in turn was postponed again to June in Japan and September 30 in the U.S., giving PlayStation a clear field for most of this year. The N64 postponements were attributed to a shortage of not only components but software as well.

Two other games seem to have fallen by the wayside. 3DO, which once had high hopes of revolutionizing the video-game market, is currently in eclipse. The 3DO company sold primary rights for its upcoming M2 64-bit graphics technology to Matsushita (Panasonic), and since then there have been no significant developments on

the 3DO game front. The dropout of Goldstar, which had planned to introduce a 3DO game console, leaves Panasonic as the only brand offering this game (and no longer pushing it vigorously). Atari, which had staked a great deal on its highly sophisticated Jaguar game, apparently has backed out, too, laying off most of its game-development team. Jaguar consoles have begun appearing at bargain-basement prices.

The pioneer in sophisticated games—Philips' CD-i—is no longer considered a consumer game system. It's being sold through channels aimed

at the educational and commercial markets. So all of this leaves PlayStation as the undisputed leader, at least for the foreseeable future—and that means through Christmas of this year. Nobody else is close enough to catch up.

## Tubes for PC/TVs

Almost every manufacturer in the TV business and in the computer business is working on a new product known as the "network computer" or the "PC/TV." These products are halfway compromises or combinations of TV sets and personal computers. In the simplest form, a network computer will be able to access the via a TV attachment. More elaborate devices are TV sets that can play CD-ROMs or with other PC features, or complete PC's that also double as TVs, such as the Gateway 2000 "Destination" system (*Electronics Now*, May 1996).

All of those systems face a common problem: A TV picture tube can't get the resolution required for easy visibility and readability of computer data. Conversely, a truly high-resolution PC monitor can't achieve the brightness generally associated with today's TV sets. Those drawbacks are resulting in a series of compromises—so called "data-grade" or "fine-pitch" picture tubes. Several TV picture-tube manufacturers currently are offering those tubes to their customers.

Those tubes—generally in the larger sizes—aren't really computer monitor tubes, but they are capable of displaying VGA-quality graphics, without materially lowering the brightness. So far, Thomson (RCA) and Toshiba have announced such tubes, and most of their competitors will be doing so soon. The high resolution is achieved by using narrower phosphor stripes on the tube face and internal shadow masks with finer openings. Take the RCA 36-inch fine-pitch tube as an example. You couldn't use it as a desktop monitor, but from across the living room, it displays satisfactory and legible computer graphics as well as an extremely high-quality TV picture. EN

# GET PLUGGED

## INTO THE ONLY SURFACE MOUNT BREADBOARDING SYSTEM

**Global Specialties**, the innovator of solderless breadboard technology, introduces the ProtoBoard Surface-Mount Breadboarding System (SMT™) designed to make life easier for circuit designers. The SMT series of protoboards provides the only quick, nondestructive and solderless method for prototyping

circuits with surface-mount chip carriers. The boards are available in five models to accommodate 20, 28, 44, 68, and 84 pin PLCCs in two configurations, breadboarding sockets and header strips. The boards are also designed to easily interface with other Global Specialties Protoboards and circuit trainers which allows for maximum circuit design flexibility.

Like all Global Specialties breadboarding products, each SMT ProtoBoard breadboarding socket, comes with an unconditional lifetime guarantee and are available at fine electronics distributors everywhere. Call us for a distributor near you.

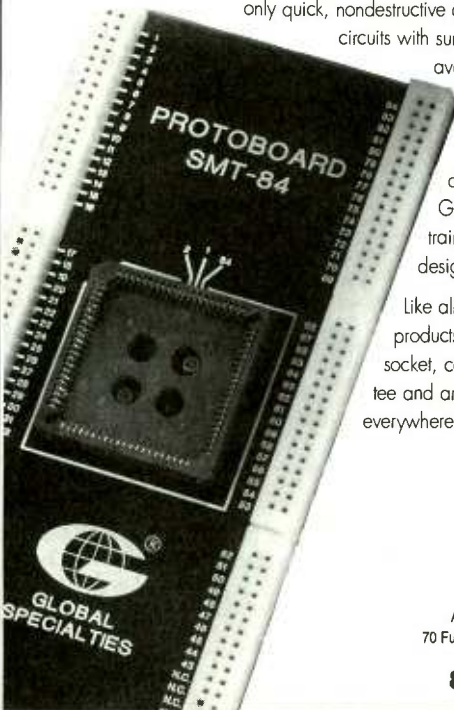

An Interplex Industries Company  
70 Fulton Terrace • New Haven, CT 06512

**800-572-1028**

CIRCLE 122 ON FREE INFORMATION CARD

[www.americanradiohistory.com](http://www.americanradiohistory.com)



# Q & A

READERS QUESTIONS, EDITORS ANSWERS

## Controlling relays by serial port

**Q** How can I use the serial (RS-232) port on my computer to control 8 to 16 relays? — R. S. C., Silver Spring, Md.

**A** Controlling relays with a parallel port would be easier because the parallel port data lines are TTL logic-level signals. But there are several reasons you might want to use a serial port. First, fewer wires are required (just two, instead of nine or more). Second, serial cables can be a lot longer (up to a quarter of a mile at low baud rates) without degrading the signal. And third, serial ports are more standardized; they work the same way whether or not the computer is a PC-compatible. This is essential if your computer happens to be a Macintosh or a Sun workstation.

Decoding the RS-232 signals is a job for a microcontroller (single-chip computer). Fortunately, you don't have to program the micro-

controller yourself; you can get a PIC 16C54A microcontroller already programmed for exactly this job from Stone Mountain Instruments (615 Field Cliff Drive, Stone Mountain, GA 30087, phone 770 413-6016, email 75377.1172@compuserve.com). What you need is part number SMI101B, priced at \$7.50 (but there's a \$25 minimum order). SMI sells a whole line of preprogrammed microcontrollers for common industrial control tasks, so you'll probably want to start by requesting a catalog.

Figure 1 shows the circuit, and Figure 2 shows a BASIC program to demonstrate how it works. Each SMI101B has eight logic-level outputs. Further, you can connect up to seven SMI101B's to a single serial port. The three "N" pins give each SMI101B a distinctive identifying number from 0 to 6. If all three are grounded, the identifier is 0; if N1 is connected to +5 volts, the identifier is 1, and so on.

At power-up, all the data outputs are off (logic "0"). To turn an output on, send a command of the

form "xNy" where *x* is the identifier of the SMI101B and *y* indicates which data output you want to switch. For example, to turn on data output 3 of a processor whose ID is 0, transmit the command "0N3" followed by ASCII code 13 (carriage return). To turn the outputs back off, use an F in place of an N (e.g., "0F3"). All communication is done with 8 data bits and no parity bits. The baud rate is 9600 baud with a 4-MHz crystal, or 1200 baud with a 500-kHz ceramic resonator.

As shown in the diagram, each relay requires a transistor to drive it, along with a resistor and a protective diode. To cut down the total number of components, you can use a relay driver chip such as the Allegro UDN2987, which contains everything necessary to drive eight small relays from logic-level signals.

## Serial port start bit

**Q** I am trying to drive an alphanumeric display from the serial port of my PC. The display requires a start bit

*continued on page 14*

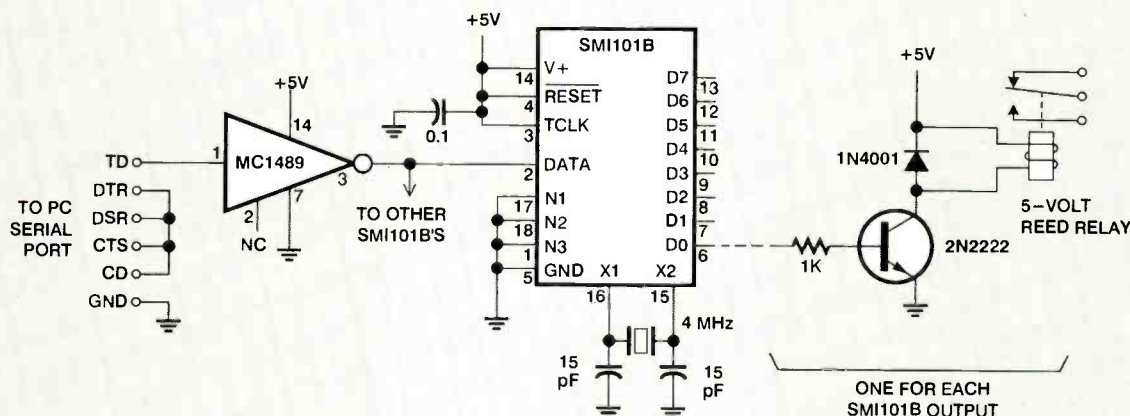

FIG. 1—THIS CIRCUIT LETS YOU CONTROL external devices from your serial port.



# LETTERS

SEND YOUR COMMENTS TO THE EDITORS OF ELECTRONICS NOW MAGAZINE

## MULTISCOPE CLARIFICATIONS

Thank you for reviewing Mission Technology's Multiscope in the May issue of *Electronics Now*. I was frankly a little disappointed with the choice of screen captures with irregular and noisy waveforms. I hope that they don't give readers an incorrect idea of the unit's capabilities.

as the data is being acquired. The Wideview mode also allows data acquisition with minimum software processing at one of ten sampling speeds ranging from 200 samples per second (0.5 milliseconds per sample) to 20 million samples per second (50 nanoseconds per sample). A total of 200 samples is taken by each sampling cycle, and then displayed on the screen. For full

learning more about the Multiscope are welcome to browse the Multiscope web page at: <http://members.gnn.com/mission/lectrnl.htm>. (Editor's note: The software is available from the *Electronics Now* BBS; 516-293-2283.)

NATHAN CHAO  
*Mission Technology*



Repeat Return

Spectrum Analyser

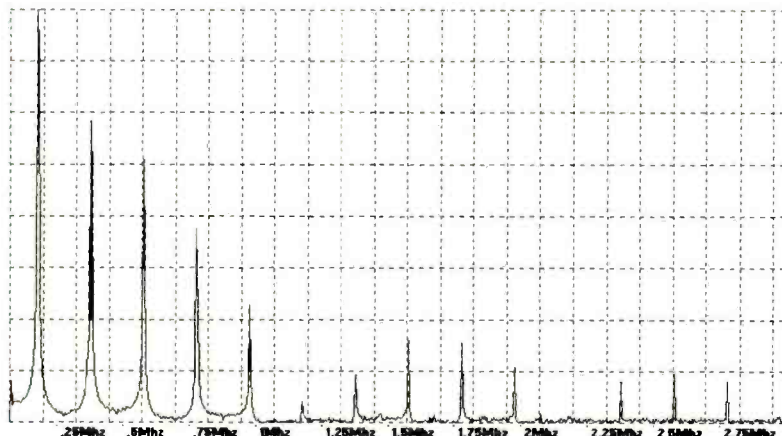

An important feature of the multiscope—omitted in the article—is the use of the unique marker bars to find the true RMS and DC values of any waveform segment enclosed between the bars. That feature could be especially useful to students.

I think that the Wideview and Burstmode operating modes also could use further explanation. In the burst mode, measurement data is red directly into the PC's memory until a user-determined number of samples are acquired. That allows much faster operation because no screen updating is done

utility, users must modify the burst and Wideview software; source code costing \$168 for both is available.

Readers who are interested in

Write To:  
Letters,  
Electronics Now Magazine,  
500 Bi-County Blvd.,  
Farmingdale, NY 11735

Due to the volume of mail we receive, not all letters can be answered personally. All letters are subject to editing for clarity and length.

## MACINTOSH PCB SOFTWARE

I enjoyed TJ Byers' article, "Low-Cost Software for PC-Board Design" (*Electronics Now*, February 1996). I found it very timely because I'm in the market for a schematic-capture and PCB-layout application suite. However, I'd like to find software that will run on my Macintosh, yet have the designs portable to my PC workstation. Does such a product exist?

THRUSTON AWALT  
*Santa Clara, CA*

Check out *Vamp Inc.* in Los Angeles, California (phone: 213-466-5533). They have a complete line of schematic-capture, PCB-layout, and circuit-simulator (analog and logic) applications for the Macintosh platform. They also plan to have a Windows version of the same software, which will be portable between the Mac and a PC, by June of this year.—TJ Byers

## MINI METROLOGY LAB

I have been following the "Mini Metrology Lab" series (*Electronics Now*, March, April, May 1996). It's terrific, offering real insights into metrology techniques. Author Conrad R. Hoffman deserves a big thank you.

I think some readers might won-

der why the Null Detector project has only moderate, 200-kilohm input impedance, even though the LTC1050 itself has CMOS-level input Z, in the Tera-ohm range. They will be used to seeing meters and scopes with 1-megohm, 10-megohm, or 11-megohm input Zs, and might want to modify the circuit for higher input divider resistances.

The reason for moderate input divider resistance is to keep the amplifier zero setting stable independent of the differing input R of each sensitivity range. The LTC1050 draws its approximately 10 pA input bias current through the source R and/or the input divider resistors. Having to re-zero null detectors for each range is a real nuisance, so it makes sense to limit the input Z. The moderate input Z also tends to minimize offset problems due to leakage currents on the circuit board.

The LTC1050 is a similar amp with a typical input bias current of only 1 pA, but has the small disadvantage of needing two external capacitors for its chopping circuit. However, for those who need to work with high-impedance sources, the LTC1052 is a better choice. Other possibilities are the non-chopper-stabilized National LMC6001 or the very expensive Burr-Brown OPA-111B. Both offer very low input bias currents; however, both have much higher offset voltage drift with changing temperature than do the LTC chopper-stabilized amps.

DICK MOORE  
Grapeview, WA

*Thank you for your interest and kind words. Your summary of the Null Detector input impedance is spot on. Commercial null detectors, past and present, tend to have a low input impedance, so the Mini Metrology version is typical in that respect.*

*Fortunately, a low input impedance is of little concern where the voltages being compared are nearly identical. Where they are not, you should always be aware of the impedances involved (including wires!), and determine if the resulting errors are acceptable. A case that comes to mind is the comparison of Weston standard cells, where even slight current flow results in significant errors (and possible cell dam-*

*age).*

*If higher input Z is needed, the LTC1052 is certainly an excellent choice. The builder should be cautioned, however, that knowledgeable layout, guarding, and scrupulous cleaning will be required to achieve maximum performance from the null detector.*

*Finally, my first designs used conventional amplifiers, and I can't recommend them. Zero stability suffered severely, and, as you say, rezeroing null detectors is a real nuisance!—Conrad Hoffman*

## THE FUTURE IS NOW

Magnetically-propelled trains operating on conventional rails ("What's News," Electronics Now, January 1996) are not new. Such a system has been operating here for the past 10 years. SkyTrain, as it is called, operates on a 28-kilometer, mostly elevated guideway serving the cities of Surrey, New Westminster, Burnaby, and Vancouver.

On-board linear induction motors push against a central reaction rail, consisting of a series of aluminum plates located on the side of the guideway. The cars are driverless, controlled by on-board computers linked to a control center. The top speed is about 80 kilometers per hour, or 50 miles per hour. That does not seem particularly fast, but it appears quite rapid compared to the snail-paced, gridlocked automobile traffic over which it passes. The route, including 20 station stops, is covered in 39 minutes. Trains run regularly every five minutes.

Just because the cars are driverless does not mean the system is unmanned. On-board personnel check tickets and maintain order. As a result, the system is virtually graffiti-free and as safe, or safer, than any similar conventional system. Most of the public complaints about SkyTrain come from those who are not served by it and would like to see it extended to their areas.

Similar, smaller systems using the same technology operate around downtown Detroit and in the Toronto suburb of Scarborough.

DAVE ELEY  
Surrey, British Columbia, Canada **EN**

# EARN YOUR B.S. DEGREE IN COMPUTERS OR ELECTRONICS



## By Studying at Home

Grantham College of Engineering, now in our 46th year, is highly experienced in "distance education"—teaching by correspondence—through printed materials, computer materials, fax, modem, and phone.

No commuting to class. Study at your own pace, while continuing on your present job. Learn from easy-to-understand but complete and thorough lesson materials, with additional help from our instructors.

Grantham offers three separate distance-education programs, leading to the following accredited degrees;

- (1) The B.S.E.T. with Major Emphasis in Electronics.
- (2) The B.S.E.T. with Major Emphasis in Computers.
- (3) The B.S.C.S. — the Bachelor of Science in Computer Science.

An important part of being prepared to *move up* is holding the right college degree, and the absolutely necessary part is knowing your field. Grantham can help you both ways—to learn more and to earn your degree in the process.

Write or phone for our free catalog. Toll free, 1-800-955-2527, or see mailing address below.

Accredited by  
the Accrediting Commission of the  
Distance Education and  
Training Council

**GRANTHAM**  
*College of Engineering*  
Grantham College Road  
Slidell, LA 70460



# EQUIPMENT REPORTS

## Staticide Laser Printer Cleaning Paper

CIRCLE 15 ON FREE INFORMATION CARD



**S**mudges, spots, streaks, toner droppings and the like usually occur after changing toner cartridges or extensive copy output. The unsightly spots sometimes occur when paper jams are cleared and the printer is jostled. That's when multiple passes with a sheet of Staticide Laser Printer Cleaning Paper removes deposits of toner and dust. Here's how we did it: The printer was set in manual mode. (Some printer manuals call it the bypass mode or hand-feed mode.) The cleaning paper is hand fed into the printer while a blank document (no type, lines, art, etc.) is transmitted from the computer to the printer. Repeat the procedure 4-5 times and discard the cleaning paper. That does it! The cleaning paper provides a quick and easy method for removing paper dust,

dirt and toner deposits from inaccessible interior areas of your laser printer. A second run of the club's logo is sharp and clean.

Fax machines that make plain paper copies can benefit likewise from a few passes of the cleaning paper.

The Staticide Laser Printer Cleaning Paper is made with individual cellulose fibers saturated with latex polymers and sealed into a paper sheet. Loose toner and dust in the printer's paper path adheres to the cleaning paper and is sealed to the paper as the hot rollers melt the latex polymers. Image quality is improved after several passes of the cleaning paper because the dust (fine paper particles from prior passes) often cannot be seen but seriously degrades the printed image quality.

Routine maintenance of your laser printer will result in high-quality printouts, reduced waste and will reduce the risk of experiencing serious and costly printer problems. There are three different packages you can purchase to obtain Staticide's Laser Printer Cleaning Paper. You can pick up a 50-sheet pack (No. 8022, \$26.50) or 12-sheet pack (#8023, \$9.50). The Staticide Laser Printer Cleaning Kit (#8016, \$30.95) includes a dozen cleaning papers plus a 2 ounce bottle of cleaning solution, 20 lint-free swabs, a lint-free anti-static wipe, and twelve ink-remover hand wipes. The kit is suitable for the periodic cleanings specified by the printer's manual. Just follow the directions of the manufacturer, and when completed, four or five passes with the cleaning paper will finish the job.

Suggested retail prices given above are usually discounted at major computer stores, office supply outlets and mail-order catalogs. Staticide printer/fax/computer products are distributed by ACL Incorporated, 1960 East Devon Avenue, Elk Grove Village, IL 60007; 708-981-9278. **EN**

## WHAT'S NEWS

*continued from page 4*

"legs" that lift the "body" of the molecule from the atomically flat copper surface. Computer simulation revealed that when pushed by the STM tip, the molecule "walks" in uncorrelated, slip-stick-like steps and exhibits precisely the desired degree of stickiness.

IBM scientists and colleagues at the University of Cambridge,

United Kingdom, developed software that moves and positions the STM tip with extreme precision. The same STM can be switched to the imaging mode by slightly increasing the distance between the tip and the surface.

The long-term goal of the research is to create new and complex molecular structures and to customize their specific functions and properties. Cu-TBP-porphyrin has several potential technological uses. By replacing the single copper

atom at its center with another metal atom with different electronic properties, for example, it could be used to construct data-storage devices with densities 100,000 times higher than today's most advanced disk drives. Also envisioned are wires only one molecule wide that could be used to build ultrasmall electronic components.

The research is part of the PRO-NANO project sponsored by the Swiss Federal Office of Education

*continued on page 66*

# Two ways to fit a 100 MHz benchtop scope in your hand.



Bigger hands.



TekScope™



Got huge hands? Then you can probably lug a benchtop scope around the field. For the rest of us, there's TekScope™, the first hand-held with true 100 MHz bandwidth and 500MS/s sample rate on both channels. It's got the familiar Tek interface, a bright, backlit display and is priced at just \$2195 MSRP. Call 1-800-479-4490, action code 709, or visit our Web site at <http://www.tek.com>.

**Tektronix**

# Surveillance Sale

Super Value! 6 Project Kits, 1 Low Price!

High performance long range (1+ mile) tunable FM transmitting devices for all applications.  
Easy to build kits! Proven technologies!

- Voice Transmitter, Ultra Clear, High Sensitivity, #XFM 
- Telephone Transmitter sends both sides of calls to FM radio, #XTL 
- Telephone Line Powered Transmitter - never needs a battery! #XIN 
- Tracking/Homing Beacon transmits Pulsed "Beeps" for trailing #XOD 
- Re-Broadcast output of video or audio to FM radio or TV, #XRW 
- TV Joker - neat prank! Allows you to disrupt a TV set; short range, #XJK 

#Combo-X - \$175 value - 6 Kits only \$59.50!

Plus FREE - with purchase of Combo-X: High Performance MicroMini FM Radio!

ATTENTION: US, Canadian customers: Home built FM transmitters when connected to antenna may exceed FCC radiated power limits.

Kits are bulk packed with all data to build the devices.  
Cash • Check • Money Order • MC • VISA • Add \$5 P&H

## AMAZING CONCEPTS

Dept EN-1 • PO Box 719 • Amherst, NH 03031  
Call 24 Hrs 800-221-1705 or Fax 603-672-5406

# ATTENTION! ELECTRONICS TECHNICIANS

EARN YOUR B.S.E.E. DEGREE

## THROUGH HOME STUDY

Our Highly Effective Advanced-Placement Program for experienced Electronic Technicians grants credit for previous Schooling and Professional Experience, and can greatly reduce the time required to complete the program and reach graduation. No residence schooling required for qualified Electronic Technicians. Through our Special Program you can pull all of the loose ends of your electronics background together and earn your B.S.E.E. Degree. Upgrade your status and pay to the engineering level. Advance rapidly! Many finish in 12 months or less! Students and graduates in all 50 states and throughout the world! Established Over 50 Years! Write or call for free Descriptive Literature. (601) 371-1351

## COOK'S INSTITUTE OF ELECTRONICS ENGINEERING

4251 CYPRESS DRIVE JACKSON, MISSISSIPPI 39212

CIRCLE 58 ON FREE INFORMATION CARD

## Q & A

continued from page 9

(logic low) and then 8 data bits and 2 stop bits. Converting the RS-232 signals to TTL is not a problem for me, but how do I generate the start bit before each character? — K. R., Rosamond, Calif.

**A** Actually, the start bit (always binary 0) is already there; the reason you've never heard of it is that all RS-232 serial ports always use it, without exception, so it's not a setting that you ever have to change or to be concerned about.

## TV repair query

**Q** My Panasonic CT5935R, which is 14 years old, has lost vertical deflection. R422, a fusible resistor, burns up instantly. Although the DC resistance of the vertical output transformer measures correct, I think it is the problem. Panasonic has obsoleted this part. My suppliers cannot help me. I cannot find an ECG or SK replacement. What can I do to save this TV set? — S. L., Brooklyn, N.Y.

**A** Hmm. If the transformer has the right DC resistances, there can't be very much wrong with it. We assume you took the transformer out of the

```
10 OPEN "COM1:9600,N,8,1" FOR OUTPUT AS #1
20 PRINT #1,"0N1" + CHR$(13)
30 FOR I=1 TO 10000: NEXT I
40 PRINT #1,"0F1" + CHR$(13)
```

' open serial port  
' turn on relay 1 of processor 0  
' pause a moment  
' turn it off again

FIG 2. — A SAMPLE BASIC PROGRAM to demonstrate serial port control.

In RS-232 (EIA-232) serial communication, negative voltages represent binary 1 and positive voltages represent binary 0. Line drivers and receivers such as the MC1488 and MC1489 invert the voltages and output ordinary TTL-compatible logic levels.

When nothing is being transmitted, an RS-232 data line is in the negative (binary 1) state. Each character starts with a start bit (always positive, binary 0), followed by seven or eight bits of data (in reverse order, least significant bit first), an optional parity bit, and the stop bits (always logical 1, negative voltage).

While it's uncommon to use 2 stop bits with 8 data bits, it's easy to do: just use a statement such as OPEN "COM1:9600,8,N,2" to open the serial port.

circuit to measure it, of course.

We've sketched part of the circuit in Fig. 3. Have you confirmed that TR451, C412, and D402 aren't shorted, and that the base of TR451 is being driven by the correct waveform? It sounds as if maybe TR451 is shorted or is being held "on" by an improper input voltage, causing the transformer to saturate and conduct excessive current.

If the transformer is defective, it shouldn't be too hard to find another vertical output transformer that has similar characteristics, though perhaps not the same physical size or shape. Start by trying to match the DC resistances. Experimentation will be required, but the transformer itself is not a highly critical component, and as you've discovered, R422 will burn out if anything is seriously wrong. **EN**

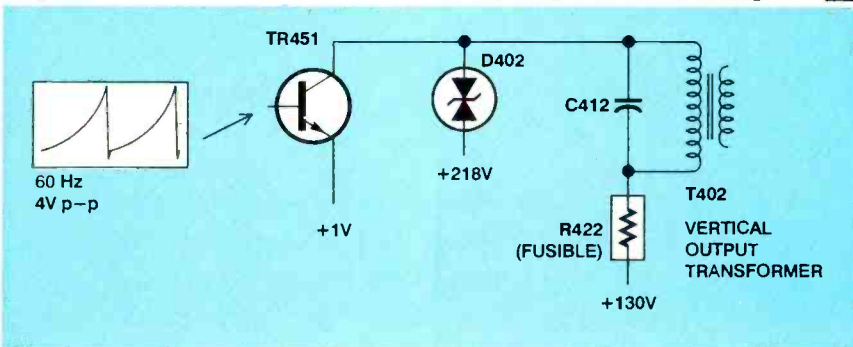

FIG. 3— WHY DOES THE FUSEABLE LINK repeatedly blow?



# CircuitMaker<sup>®</sup>

## The Virtual Electronics Lab<sup>™</sup>

where you can launch today's electronics project  
into tomorrow and beyond...

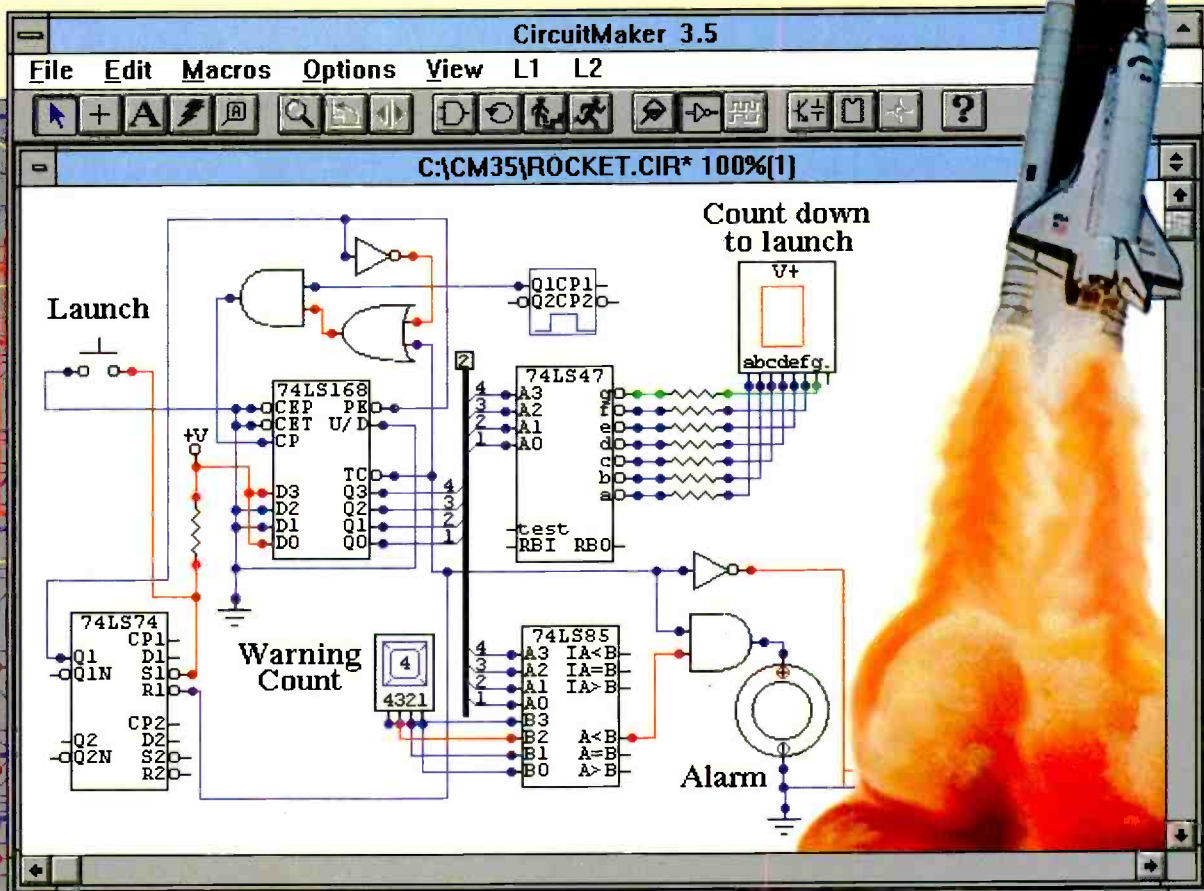

### TraxMaker<sup>™</sup>

- DOS version only \$299
- 30 day satisfaction guarantee
- user definable "Design Rules"
- imports CircuitMaker PCB netlist
- automatic or manual routing of tracks
- 8 layer, 32" x 32" maximum board size
- automatic or manual component placement

*New Product*

### CircuitMaker<sup>®</sup>

- still only \$299
- PCB netlist export
- includes 1500+ devices
- SPICE netlist import/export
- 30 day satisfaction guarantee
- professional schematic features
- digital, analog and mixed-mode simulation

*New Windows 95/NT/3.1x Versions*

Call now to order your complete circuit design system  
or request additional information:

# 800-419-4242

**MicroCode Engineering**  
573 W. 1830 N. Suite 4  
Orem, UT 84057 USA  
Phone (801) 226-4470  
FAX (801) 226-6532

**FREE ON-LINE DEMO:**  
AOL; file search, CircuitMaker  
CompuServe; GO MICROCODE  
Internet: <http://www.microcode.com>  
All trademarks are the property of their owners.



CIRCLE 128 ON FREE INFORMATION CARD



# NEW PRODUCTS

USE THE FREE INFORMATION CARD FOR FAST RESPONSE

## MAGNETICS DESIGNER SOFTWARE

INTUSOFT'S MAGNETICS Designer is a Windows-based program that helps engineers design all types of transformers and inductors. Typical design applications include high-frequency switching regulator transformers and output chokes for off-line full-wave and forward converters, 60-Hz single-phase line

spreadsheet template. A variety of core families from vendors such as TDK, Magnetics, Philips, Thomson, Micrometals, and Ferrite International is represented, each with its respective magnetic and geometric properties. The program predicts magnetizing and leakage inductance, interwinding

which is customizable with different levels of complexity. Third is a specialized "winding sheet" that describes how to build the magnetic device, including information about the materials and test specifications for your device.

A detailed applications manual provides information for the engineer who wants to learn more about magnetics design. It describes the design equations and algorithms used, discusses core materials and geometries, and presents detailed examples. Virtually all of the program's documentation is also available on-line.

Magnetics Designer is available at a special introductory price of \$1000 until June 28, 1996. After that, the price will be \$1500.

### INTUSOFT

P. O. Box 710

San Pedro, CA 90733-0710

Phone: 310-322-0710

Fax: 310-833-9658

Website: <http://www.intusoft.com>

CompuServe: CADD/CAM/CAE

Vendor forum, Library 21

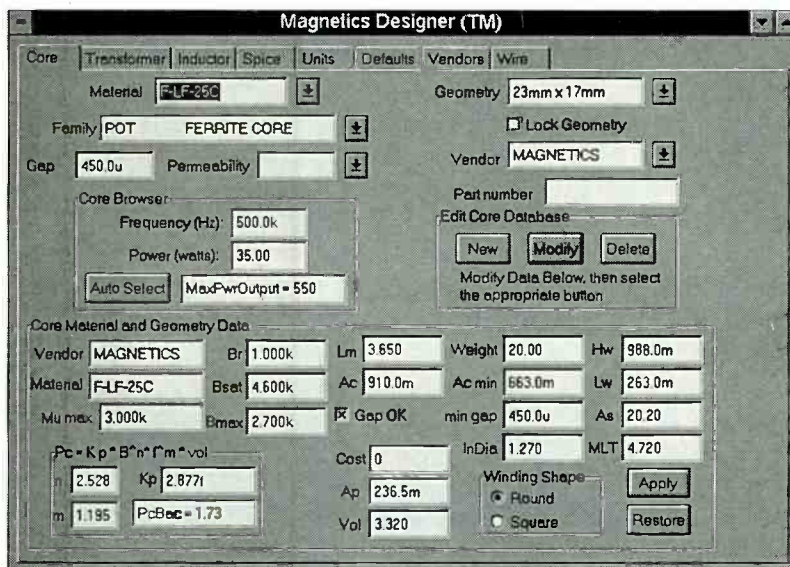

CIRCLE 20 ON FREE INFORMATION CARD

transformers, AC inductors, planar magnetics, and 400-Hz aircraft transformers. Virtually any single-phase, layer-wound inductors or transformers from 10 Hz to over 1 MHz can be synthesized with Magnetics Designer.

The software produces a complete transformer or inductor design based on electrical specifications. A database with thousands of cores and a wide variety of materials is included. You can add your own core and material information to the database, using a supplied Excel

capacitance, peak flux density, DC winding resistance, high-frequency AC resistance, copper loss (both AC and DC), core loss, weight, temperature rise, layer fill, and window fill percentage.

Magnetics Designer has three unique features. First, it exposes the mathematical equations and algorithms it uses to calculate the transformer or inductor performance. The second function is a SPICE-modeling capability; the software produces a Berkeley SPICE model of the transformer or inductor,

## ELECTRICAL CONTROL TOOL KIT

JENSEN TOOLS' JTK-67C IS A tool kit designed specifically to meet the rigid demands of electrical control officers. More than 100 high-quality, insulated and non-insulated tools make up the essential selection. The kit includes parts boxes to hold and display the many consumable-type items required on a daily basis by electrical-control engineers.

The tool assortment is securely housed in a three-sided Cordura

## Just like these Fully Trained Electronics Professionals



*"Thanks to CIE I have tripled my previous salary, and I am now in a challenging and rewarding new field where only the sky is the limit."*

**Daniel Wade Reynolds**  
Industrial Electrician  
Ore-Ida Foods



*"CIE was recommended to me by my boss. It was appealing since I could study at my own pace at home and during business travel."*

**Dan Parks**  
Marketing Manager/Consumer Products  
Analog Devices, Inc.



*"I loved the flexibility CIE offered. It was the only way I could continue both school and my demanding job."*

**Britt A. Hanks**  
Director of Engineering  
Petroleum Helicopters, Inc.



*"I liked the way the school was set up with laboratory assignments to enforce conceptual learning. The thing which impressed me the most about CIE's curriculum is the way they show application for all the theory that is presented."*

**Daniel N. Parkman**  
Missile Electro-Mechanical Technician  
U.S. Air Force



*"Completing the course gave me the ability to efficiently troubleshoot modern microprocessor based audio and video systems and enjoy a sense of job security."*

**Tony Reynolds**  
Service Manager/Technician  
Threshold Audio & Video

# Graduate with an Associate Degree from CIE!

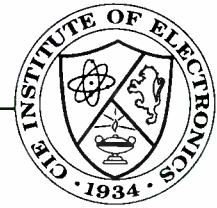

CIE is the best educational value you can receive if you want to learn about electronics, and earn a good income with that knowledge. CIE's reputation as the world leader in home study electronics is based solely on the success of our graduates. And we've earned our reputation with an unconditional commitment to provide our students with the very best electronics training.

Just ask any of the 150,000-plus graduates of the Cleveland Institute of Electronics who are working in high-paying positions with aerospace, computer, medical, automotive and communications firms throughout the world. They'll tell you success didn't come easy...but it did come...thanks to their CIE training. And today, a career in electronics offers more rewards than ever before.

### CIE'S COMMITTED TO BEING THE BEST...IN ONE AREA...ELECTRONICS.

CIE isn't another be-everything-to-everyone school. CIE teaches only one subject and we believe we're the best at what we do. Also, CIE is accredited by the National Home Study Council. And with more than 1,000 graduates each year, we're the largest home study school specializing exclusively in electronics. CIE has been training career-minded students for nearly sixty years and we're the best at our subject...  
**ELECTRONICS... IT'S THE ONLY SUBJECT WE TEACH!**

### CIE PROVIDES A LEARNING METHOD SO GOOD IT'S PATENTED.

CIE's AUTO-PROGRAMMED® lessons are a proven learning method for building valuable electronics

career skills. Each lesson is designed to take you step-by-step and principle-by-principle. And while all of CIE's lessons are designed for independent study, CIE's instructors are personally available to assist you with just a toll free call. The result is practical training... the kind of experience you can put to work in today's marketplace.

### LEARN BY DOING...WITH STATE-OF-THE-ART EQUIPMENT AND TRAINING.

CIE pioneered the first Electronics Laboratory



Course and the first Microprocessor Course. Today, no other home study school can match CIE's state-of-the-art equipment and training. And all your laboratory equipment, books and lessons are included in your tuition. It's all yours to use while you study and for on-the-job after you graduate.

### PERSONALIZED TRAINING...TO MATCH YOUR BACKGROUND.

While some of our students have a working knowledge of electronics others are just starting out. That's why CIE has developed twelve career courses and an A.A.S. Degree program to choose from. So, even if you're not sure which electronics career is best for you, CIE can get you started with core lessons applicable to all areas in

electronics. And every CIE Course earns credit towards the completion of your Associate in Applied Science Degree. So you can work toward your degree in stages or as fast as you wish. In fact, CIE is the only school that actually rewards you for fast study, which can save you money.

## YES!

I want to get started. Send me my CIE course catalog including details about the Associate Degree Program. (For your convenience, CIE will have a representative contact you - there is no obligation.)

Please Print Clearly

Name \_\_\_\_\_

Address \_\_\_\_\_

City \_\_\_\_\_

State \_\_\_\_\_ Zip \_\_\_\_\_ Age \_\_\_\_\_

Phone No. \_\_\_\_\_

Check box for G.I. Bill Benefits.

Veteran

Active Duty

**AE87**

Cleveland Institute of Electronics, Inc.  
1776 East 17th Street  
Cleveland, OH 44114

*A School of Thousands.  
A Class of One. Since 1934.*

Send for CIE's FREE Course Catalog and See How We Can Help Your Career Too!



CIRCLE 21 ON FREE INFORMATION CARD

Plus nylon case that organizes the various items and has ample room for optional test and diagnostic equipment. The case, which measures 18×12×9 inches, features sturdy web-strap carrying handles and a shoulder strap. The outer two case compartments hold tools and optional gear, while the center compartment can accommodate manuals, paper work and diskettes. A padded pocket can hold a laptop or notebook computer.

The JTK-67C electrical-control engineer's kit costs \$649 in single unit quantities; three or more cost \$597 each.

#### JENSEN TOOLS

7815 South 46th Street  
Phoenix, AZ 85044  
Phone: 1-800-426-1194  
Fax: 1-800-366-9662

## 50,000-COUNT DIGITAL MULTIMETERS

THE ASYC II SERIES OF handheld digital multimeters from European-based Metrix Instruments provides high levels of accuracy, resolution, and safety. All four models digitally display resolution of 50,000 counts, a 25-fold improvement over traditional 2000-count DMMs, and offer true-RMS measurement (AC and DC plus AC) for accurately handling irregular waveforms.

The four ASYC II series meters feature basic DC accuracy to 0.025% and bandwidths to 100 kHz, and will automatically store the last reading. Hold, fast, peak capture, and relative

reading modes are provided. Also included are comprehensive autoranging voltage, current, capacitance, frequency (to 500 kHz) measurements, as well as percentage duty-cycle, positive or negative pulse width, and pulse-counting features. The top-of-the line model features a patent-pending resistive power function that offers a choice of reference resistances.



CIRCLE 22 ON FREE INFORMATION CARD

The ASYC—which stands for Advanced Safety Concept—meters provide a host of safety features, including full water and dust sealing to IP677 standards. A separate compartment allows the battery or fuses to be replaced without the need for metal tools and without breaking any calibration label, avoiding risks associated with opening the unit. Test lead retainers keep the leads from being accidentally disconnected.

Prices for the ASYC II series of handheld digital multimeters range from \$250 to \$400.

#### METRIX INSTRUMENTS

P. O. Box 332  
Brea, CA 92622-0332  
Phone: 714-992-1239

## LOW-FREQUENCY TRANSDUCER

THE MODEL BRT 1612P-12 LOW-frequency transducer from the Intervox division of International Components Corporation is designed for use in communications equipment, automobiles, computers, and security systems. It boasts a frequency of just

1.7 kHz, compared to the 2.02-kHz frequency found in conventional units of its type. Only 12mm high, the transducer is also 14% shorter than standard models. To further distinguish it from other transducers, its case is gray instead of standard blue.

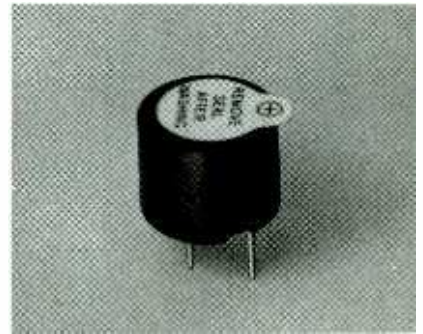

CIRCLE 23 ON FREE INFORMATION CARD

The Intervox BRT 1612P-12 has a flat frequency response of 1.7 to 2.2 kHz, allowing a wide bandwidth of 500 Hz. Its sound pressure level (dB) is 85 min./10cm, and its operating temperature range is -40° to 90°C. The device is wave solderable and washable.

The Intervox BRT 1612P-12 low-frequency transducer costs \$0.55 each in quantities of 10,000 pieces.

#### INTERNATIONAL COMPONENTS CORPORATION

OEM Sales Department  
107 Maxess Road  
Melville, NY 11747  
Phone: 516-293-1500

## CATV SIGNAL-LEVEL METER

THE LF 941 IS AN EASY-TO-USE VHF/UHF CATV signal-level meter from Leader Instruments. Covering the 46 to 870-MHz range, the LF 941 provides eight user-selectable channel tables for worldwide operation. A PLL synthesizer ensures quick, accurate tuning throughout the selected measurement range. Coverage for the United States is channels 2 through 136, and 46 to 870 MHz.

Hands-free automatic level attenuation and tracking simplifies operation and speeds throughput within the measuring range of +50 to -30 dBmV. One button toggles between the mea-



CIRCLE 24 ON FREE INFORMATION CARD

sured channels' visual or aural signal level measurement modes. Pressing the VHF/UHF or CATV button during power-up switches to the respective mode. A monitor phone output jack with adjustable volume control and on-screen indication is provided for quick sound checks. The large LCD readout shows visual or aural signal levels along with the engineering unit, volume control level, and a signal-level bar-graph for peak analysis during CATV alignments.

The LF 941 CATV signal-level meter costs \$995.

**LEADER INSTRUMENTS CORPORATION**

380 Oser Avenue  
Hauppauge, NY 11788  
Phone: 516-321-6900  
(in NY) or 1-800-645-5104

**AC POWER SUPPLY**

GLOBAL SPECIALTIES' MODEL 1504 is a continually variable, triple-isolated, digital AC power source with line leakage and current tester and digital panel meter indicators. Designed specifically for situations in

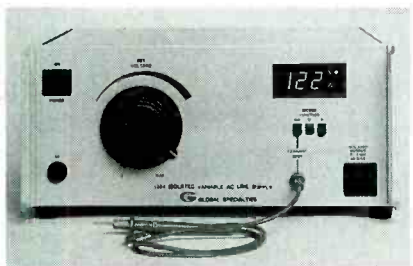

CIRCLE 25 ON FREE INFORMATION CARD

which a clean, electrostatically and galvanically isolated variable-line supply is needed, it can be used in circuit design and development labs, production-line testing and repair facilities, companies that do incoming electronic inspection, and technical schools.

The transformer output voltage is

# Raise your standard to Wavetek.

**W**hy choose between paying more for a brand name or getting more functions for your money? Get the best of both worlds with **Wavetek**.

**Worldwide Service.** Support whenever and wherever you need it.

**Tech-preferred Features.** The XL meters have the largest displays, auto-off, data hold, manual and autoranging models in pocket-size convenience.

**Quality.** Less than 0.5% warranty returns assures continuous reliability.

**Selection.** Over 35 different **Wavetek** DMMs to meet any measurement need.

**User Safety.** Conservative voltage ratings, fused inputs, warning beepers, shrouded test leads, and designs that meet worldwide agency approvals.

**Total Value.** Eight XL Series meters from \$29.95 to \$99.95 to meet any requirement.

You don't need to pay more.  
You can't afford to settle for less...

**For the name and location of the Wavetek dealer near you, call**  
**1-800-854-2708**  
(outside the U.S., call 619-279-2200)

**Wavetek Corporation**  
9045 Balboa Avenue,  
San Diego, CA 92123

©Wavetek Corp., 1995. Wavetek and the Wavetek logo are registered trademarks of the Wavetek Corporation

**WAVETEK**

CIRCLE 98 ON FREE INFORMATION CARD

continuously adjustable from 0 to 150 volts AC at 0 to 4 amps. To protect the user against shock, the Model 1504 is triple-shielded from the input line. It can measure power-line leakage current via a probe and a switch-selected range of the output digital panel meter.

The Model 1504 AC power supply costs \$420.

#### GLOBAL SPECIALTIES

70 Fulton Terrace  
New Haven, CT 06512  
Phone: 1-800-572-1028  
Fax: 203-468-0060

included in the user's manual, shows all board settings on a single page.

All of the 64/32 card's features are configurable. Users can replace relays, change signal access, modify wiring, and change board address selection. The card supports dry reed, mercury wetted, normally open, normally closed, and TTL drivers, which can be mixed on the same board. That means that applications are not limited to a single relay type, and users are not limited as to how signals are connected to the outside world. Signals can pass through the board individually or

grouped to a common output. The card also includes wire wrap option headers that allow users to re-wire the board into any possible array of special relay/signal interactions. Its board selection of port addresses prevents system component conflicts and allows the installation of as many switch cards as there are available slots.

**ACCUSYS, INC.**  
Information Group  
3695 Kings Row  
Reno, NV 89053  
Phone: 702-746-1111

EN

## PC MASTER CONTROL CARD

THE MASTER CONTROL 64/32 switch card from AccuSys gives any personal computer the means to "power up" the world around it. Requiring just one ISA bus slot, the card enables a PC to switch up to 64 signals to automate homes or offices, control heating systems, turn industrial equipment on and off, connect test samples to a single data source, open irrigation channels, and more.

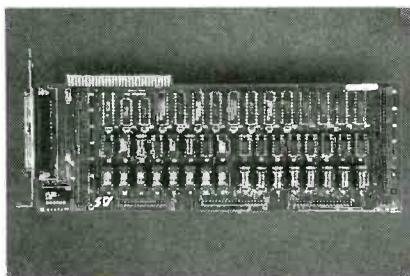

CIRCLE 26 ON FREE INFORMATION CARD

The Master Control card contains 32 relays that are operated with simple software commands that can be issued from within most applications. Software examples written in Assembler, Basic, Fortran, C, COBOL, FoxPro, and dBase are included, along with operating software for Windows and DOS to toggle the relays on and off. Users can operate one or many relays with the click of a mouse button. This lets your PC turn on lights, control heating systems, open irrigation systems, or handle almost any control application. A one-page guide,

# WAVE GOODBYE TO PRICED TEST EQUIPMENT

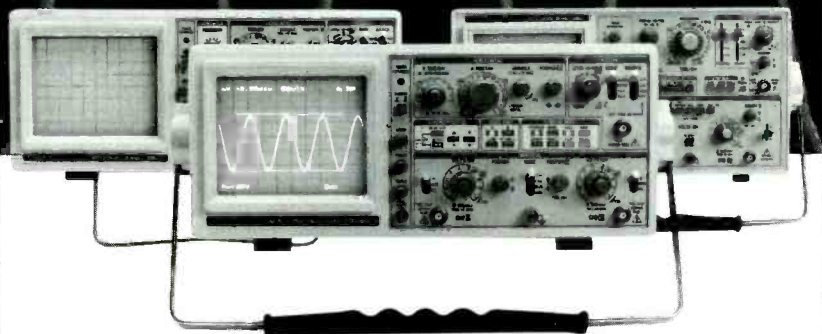

GoldStar offers a comprehensive line of affordable Analog and Digital Storage Oscilloscopes for your diagnostic needs.

- Signal Delay Lines
- Variable Holdoff
- TV Sync
- Max. Sweep Time of 2ns/div.

Digital Storage with CRT Readout and Cursor Control	Analog CRT Readout and Cursor Control	Analog
OS-3020: 20 MHz, 20 MS/s	OS-902RB: 20 MHz, Delayed Sweep	OS-9020A: 20MHz, Basic
OS-3040: 40 MHz, 20 MS/s	OS-904RD: 40 MHz, Delayed Sweep	OS-9040D: 40MHz, Delayed Sweep
OS-3060: 60 MHz, 20 MS/s		OS-9060D: 60MHz, Delayed Sweep
		OS-8100A: 100MHz, Delayed Sweep
		OS-9020G: 20MHz with 1MHz Function Generator

Don't forget the other sensibly priced instruments available from GoldStar (Sweep Function Generators, Frequency and Universal-Counters, Bench Power Supplies, and Bench and Handheld-Digital Multimeters).

 **LG Precision**  
The Sensible Source

13013 East 166th St., Cerritos, CA 90701 310-404-0101 fax: 310-921-6227

# The Four-Year Electronics Degree Program That Really Hits Home!

**Bring The Technology Home With A Bachelor Of Electronics Engineering Degree. No Hassles. No High Cost!**



*Now's the time to prepare for a profitable career.*

## We've lowered the cost of higher education.

It's true! You can earn a four-year Bachelor of Electronics Engineering Technology degree today ... and prepare yourself for a high-paying electronics career ... without quitting your job or ever leaving your home. Because World College, an affiliate of the Cleveland Institute of Electronics, offers you the total flexibility of independent study programs proven effective for people like you who truly want to succeed! World College independent study lessons help you build valuable skills

**Mail/Fax Today  
or Call  
1-800-696-7532**

step-by-step, and expert instructors are personally available to you with a toll-free call. What a way to earn an education!

## A world of opportunity.

Where is your career headed? With a four-year bachelor's degree from World College, you call the shots, choosing from incredible, high-paying opportunities in electronics, tele-communications, computer, electrical power, and many other growing fields.

World College gives you the skills, the knowledge, the power to take advantage of your best opportunity in electronics. And you can do it all at your own pace!

### Without leaving home.

World College continually works to provide its students with the most advanced education tools. From the latest equipment and reference books to breakthrough computer-simulated experiments, students are exposed to the latest technological advancements.

All the equipment, parts, and software you need are included in your affordable tuition, including more than 300 hands-on lab experiments you can complete in your home.

### Choose your own pace.

Earn your bachelor's degree on your time — and at your pace — because you pay tuition to World College only as you complete the upper-level semesters close to graduation. The faster you make it through, the less you pay. So you have an incentive to make your future happen quickly — yet the freedom to choose your own pace!

Send today for your FREE course catalog — and give yourself that future you've always wanted — with an electronics degree education from World College.



*Take charge of your future in electronics.*

## Four Powerful Reasons To Connect With World College Today:

- 1. Earn your four-year degree!**
- 2. Self-paced training!**
- 3. Independent study in your home!**
- 4. Expert instruction!**

## Give Me The Power!

Send me a FREE World College course catalog today!



(Please Print Neatly)

Name \_\_\_\_\_

Address \_\_\_\_\_

City \_\_\_\_\_

State, Zip \_\_\_\_\_

Phone (     ) \_\_\_\_\_

Age \_\_\_\_\_

**For faster service, call  
1-800-696-7532,  
or call  
1-804-464-4600.**

**Or fax this coupon to  
1-804-464-3687.**



Lake Shores Plaza  
5193 Drive, Suite 113  
Virginia Beach, VA 23455-2500



Affiliated with  
Cleveland Institute of Electronics

WAE33



# NEW LITERATURE

USE THE FREE INFORMATION CARD FOR FAST RESPONSE

## 1996 EEM/Electronic Engineers Master

*Hearst Business Publishing  
UTP Division*

645 Stewart Avenue  
Garden City, NY 11530

Phone: 516-227-1314

Credit Card Orders: 1-800-833-7138

Fax: 516-227-1453

**4-Volume Catalog: \$99**

**(plus \$10 shipping)**

**CD-ROM for Windows: \$115**



CIRCLE 337 ON FREE INFORMATION CARD

For the first time in its 38-year history, the *EEM/Electronic Engineers Master* catalog is available on a CD-ROM as well as in its

traditional, multi-volume printed form. The electronic version combines the scope of the EEM database with the speed and ease of CD-ROM technology to provide fast and efficient access to all the information in the world's largest catalog of electronic products. Users can search by product or by manufacturer.

Both EEM versions feature updated and expanded information, including more than 4400 new and updated product pages from more than 1000 manufacturers; over 4100 different product listings with hundreds of new products; 5300 manufacturers listings with their local sales offices; 63 product sections, including new sections on LAN products, terminal blocks, and test accessories; 30 product selection guides; 20 mini-glossaries and charts, expanded with the latest hard-to-find technical details; and

address and telephone changes for more than 1000 manufacturers.

## Transformers and Tubes in Power Amplifiers

*by Menno van der Veen*

*Plitron Manufacturing*

*250 Wildcat Road*

*Toronto, Ontario M3J 2N5*

*Canada*

Phone: 416-667-9914

Fax: 416-667-8928

**\$26 (U.S)**

**\$32 (Canada)**

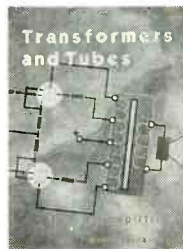

CIRCLE 338 ON FREE INFORMATION CARD

audio amplifiers using vacuum tubes have found a niche in the marketplace.

This book, which is aimed at audio enthusiasts, hobbyists, and professional audio designers, deals with the importance of output transformers in vacuum-tube amplifiers. Beginning with a basic description of what an output transformer does, the book goes on to discuss the connection of power output tubes and loudspeakers to the transformer and the importance of frequency range and time behavior. One chapter is devoted to formulas that describe the complete mathematical model of time and frequency behavior of an output transformer. While the information

can be applied to all tube amplifiers, special attention is given to the remarkable results that can be achieved with toroidal output transformers.

Subsequent chapters describe how to design and build a tube-power amplifier. The book also provides useful remarks about experiments, special solutions to specific problems, and many valuable old rules that will help readers to design and build a high-quality vacuum-tube amplifier.

## Radio on the Road: The Traveler's Companion

*by William Hutchings*

*Arrowhead Publishing*

*P.O. Box 1619*

*Lake Arrowhead, CA 92352-1619*

Phone: 1-800-432-7274

**\$12.95 (plus \$3**

**shipping and handling)**



CIRCLE 339 ON FREE INFORMATION CARD

What radio stations do you listen to when you're traveling on business or pleasure, or when you've reached your destination? Do you have a hard time finding the jazz or classical station you'd prefer to be hearing.

Aimed at RV owners, salespeople, commuters, and vacationers, this book provides a handy alternative to channel-surfing the radio dial when you're out of town. It lists more than 14,000 AM, FM, and TV stations in the United States and



Just Published! From one of America's best-known authors on electronics repair...

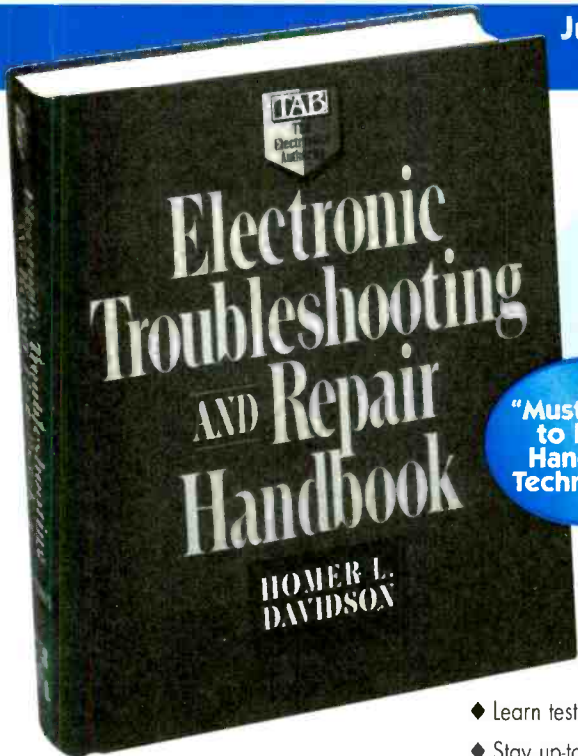

A  
"Must Have"  
to Learn  
Hands-on  
Techniques!

# Learn Professional Electronic Troubleshooting and Repair Techniques!

Now you can have the most complete and up-to-date guide to professional electronics troubleshooting and repair available today — right at your fingertips.

- ◆ Get practical information that is technically correct and extensively field tested.
- ◆ Learn testing techniques for resistance, current, frequency and solid-state components.
- ◆ Stay up-to-date on such state-of-the-art products as digital audio tape, VCRs, microwave ovens, CD players and computers.
- ◆ You even get a full chapter on servicing imported electronics.

## 43 Information-Filled Chapters Including:

- How to use the digital multimeter
- Required electronic tests, tools & techniques
- Isolate, locate and repair circuits & components
- Servicing low-voltage power supplies
- How to signal trace various circuits
- Identifying and replacing unknown parts
- Servicing remote control devices
- How to service without a schematic
- Keeping test equipment in top shape ...and much more!

Increase your level of expertise and make those tough repairs easily and quickly by enhancing your diagnostic skills, improving your ability to read schematics and recognize key electronic components. This massive — over 1,100 pages — reference is filled with hundreds of helpful photos, drawings and diagrams. Understand and diagnose today's complex consumer electronics with ease. Order your copy now!  
**1,104 pp., 1,125 illus., #015676-X, \$69.00**

FOR FASTEST SERVICE CALL ☎ **1-800-822-8158** (24 hours a day)  
or Fax 1-614-759-3644

**YOUR SATISFACTION IS ABSOLUTELY GUARANTEED!**

If you are not satisfied with your selection, simply return it for replacement or a full refund. We even pay the postage.

### GET A FREE UNIVERSAL TEST LEAD KIT WITH YOUR PAID ORDER!

Measure Voltage. Check your currents. Rig components. Look for defects. And more! You can do it quickly and easily with the Universal Test Lead Kit. And it's yours FREE when you buy **Electronic Troubleshooting and Repair Handbook**.



Mail to:  
**McGraw-Hill, Inc.**  
P.O. Box 182607  
Columbus, OH 43218-2607

YES! Please rush my copy of Electronic Troubleshooting and Repair Handbook by Homer L. Davidson (#015676-X). I have enclosed payment of \$69.00 (plus \$6 S&H and any applicable taxes). Also, please be sure to include my FREE Universal Test Lead Kit!

Name \_\_\_\_\_

Address \_\_\_\_\_

City \_\_\_\_\_ State \_\_\_\_\_

Zip \_\_\_\_\_ Phone (\_\_\_\_) \_\_\_\_\_

#### PAYMENT METHOD:

Check or Money Order enclosed  
(payable to McGraw-Hill, Inc.)

Please charge my credit card:



Acct. No. \_\_\_\_\_

Exp. Date \_\_\_\_\_

Signature \_\_\_\_\_

Professional books may be tax deductible. Ask your tax advisor.

KEY = SP66ENA

Canada. Stations can be located by state, city, and (most important) by program format. More than 600 National Public Radio stations are included. The book also lists weather data, road-condition hot lines, and favorite points of interest for each one of the 50 states.

## The Internet and World Wide Web Explained

by J. Shelley

Electronics Technology Today Inc.

P.O. Box 240

Massapequa Park

NY 11762-0240

(Order No. BP 403)

Credit card orders 1-516-293-0467

**\$6.95 (plus \$3 shipping and handling)**



CIRCLE 340 ON FREE INFORMATION CARD

This book cuts through all the media hype and technical jargon to explain what the Information Superhighway really is and how it relates to the Internet and the World Wide Web. It defines the terms you need to know (protocols, ftp, gopher, TCP, hypertext, http, URL, home pages, threads, HTML, domains, and the like) in plain and simple English. By reaching a thorough understanding of their meanings, the reader can talk to, and at the same level as, the techies who dreamed them up.

The book provides readers with the knowledge and expertise needed to use the Internet. It answers commonly asked questions, including: Where did the Internet come from? What can I get from it? How can I contact others with similar interests? How can I send e-mail and order things over the Internet? What will it cost to get hooked up and to use the Internet? Should I worry that my computer will be violated by hackers or infected with viruses?

Finally, the book takes a look at what the future holds in store for the Internet.

## Programmer's Guide to Online Resources

by Bob Kochem

John Wiley & Sons, Inc.

605 Third Avenue

New York, NY 10158-0012

Phone: 1-800-CALL-WILEY

Website: [www.wiley.com/compbooks/](http://www.wiley.com/compbooks/)

**\$24.95**



CIRCLE 341 ON FREE INFORMATION CARD

Although the Internet is overflowing with valuable resources for programmers, trying to navigate through all the information can be time-consuming and frustrating. This book gives programmers a road map to all the technical data, programming utilities, software, and other valuable material available on the World Wide Web. It provides information on sources of code and tools; vendor support sites; programmer question-and-answer groups; magazine archives and databases; multimedia and virtual reality; security, encryption, and anti-virus material; networking and communications; and operating systems and environments.

## Amateur-Radio Kit Catalog No. A-96

T-Kit Division of Ten-Tec, Inc.

1185 Dolly Parton Parkway

Sevierville, TN 37862-3710

Phone: 423-453-7172

Credit card orders: 1-800-833-7373

Fax: 423-428-4483

**free**



CIRCLE 342 ON FREE INFORMATION CARD

FM transceiver for just \$195. Also fea-

tured are kits for building a 2-meter HT RF power amplifier, a 6-meter SSB/CW/ FM transverter, a 9-band shortwave receiver, mobile and desk microphones, a combination SWR bridge/RF wattmeter, a 2-meter FM transceiver with 15 memories, several budget-priced receivers, and more. "Little Kits" (module PC-boards) are offered for those who prefer to find their own kit-finishing hardware to custom finish their projects. The catalog also includes enclosures and Enclosure-Plus Hardware Paks.

## Datacom/Networking Cookbook No. 9

Telebyte Technology, Inc.

270 Pulaski Road

Greenlawn, NY 11740

Phone: 1-800-TELEBYT

or 516-423-3232

Fax: 516-385-8184

Website: <http://telebyteusa.com>

**free**



CIRCLE 343 ON FREE INFORMATION CARD

This catalog provides a host of solutions for premises and local data communications problems, and describes Telebyte's product lines, from modems to fiber-optic multiplexers and LAN media converters. To help datacom professionals, electronic design engineers, and people involved with process control and manufacturing make swift, informed purchasing decisions, it offers detailed product descriptions, specifications, and prices, along with convenient descriptions of common interfaces and a glossary of terms.

New products are featured in several categories, including short-haul modems, interface converters, datacom test equipment, lightning protection, and multiplexers. The Cookbook draws attention to the company's new approach of providing an LCD read-out built into its power-stealing products. The LCD simplifies installation and network testing, and eliminates the need for a separate breakout box. **EN**

# Bumpy rides

**ONE OF MY THREE-YEAR-OLD'S FAVORITE GAMES IS CALLED "BUMPY RIDES." I HOLD HIM IN MY ARMS, AND WE GO BOUNCING UP AND DOWN THE STAIRS. HE ALWAYS ENDS UP SQUEALING WITH LAUGHTER.**

Grownups, on the other hand, don't seem to enjoy bumpy rides quite as much—especially when the issue is cross-platform networking and connectivity. Here's the story to date of my recent bumpy ride in that domain. It has not left me squealing with laughter, but everything works, and most of my goals were achieved.

My goals were simple enough: I just wanted all of the computers in my office to be able to communicate with each other regardless of location, CPU, and operating system. I also wanted an integrated dial-in/dial-out modem capability, centralized backup, printer sharing, a minimal number of network protocols, and capability of running a Web server.

The list of machines includes a Power Macintosh running System 7.5; several desktop PC's running various combinations of Windows 3.11, Windows 95, Windows NT, OS/2 Warp, and Linux; and an "old" HP subnotebook, the OmniBook 300, running Windows 3.1.

The whole process would have been considerably simpler if my budget had been larger. If so, I could have bought a better (dedicated) server and a modern (read *com-*

*patible*) laptop. But it wasn't, so I couldn't, so compromises were struck and workarounds developed.

What I ended up with is a mostly peer-to-peer network, with some peers being more equal than others. The most powerful machine serves as my main workstation; it also performs automated nightly backup of all the other machines, and provides server-like centralized storage for some of the other machines. It also runs three network protocols

(TCP/IP, NetBEUI, and AppleTalk), and functions as a file and print server for the Power Mac.

Getting the basic PC network up and running was simple. Windows 95 does an admirable job of supporting multiple network protocols and clients. In fact, I had been using its peer networking features since early in the Windows 95 beta program. I had no trouble sharing files and printers across Windows 95, Windows 3.1, and DOS-only machines.

## Mac Integration

It had been a few years since I'd been directly involved in networking Macs, so I had some trepidation—totally unfounded, as it turned out. After doing some

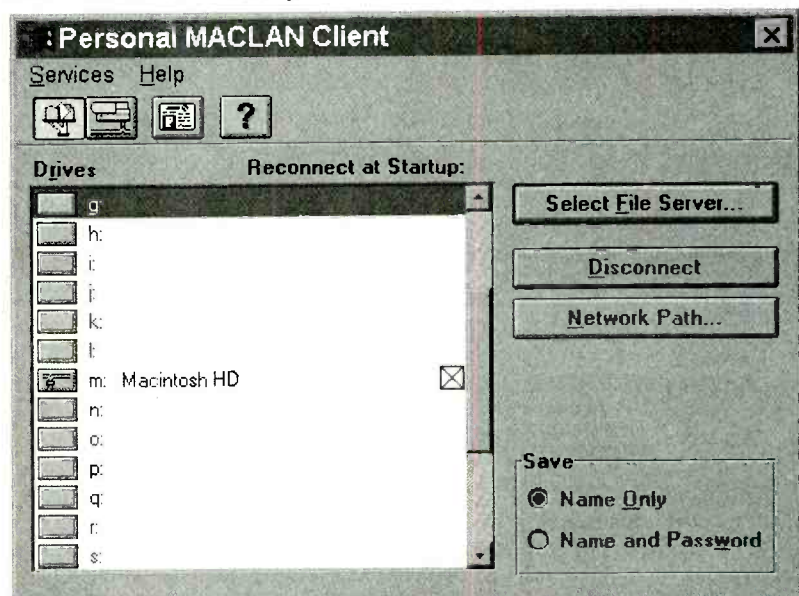

Miramar's MacLan Connect allows seamless integration of Macintoshes in a PC network. The current version (5.51) is incompletely integrated with Win95, but the next version promises complete, transparent integration.

research, I settled on a product called MacLan Connect, by Miramar Systems. It has some limitations, and some awkward features, but it basically works. It seamlessly integrates the Power Mac with the Windows/DOS machines, to the point where: 1) The Mac can use my main workstation for storage, 2) My main workstation's SCSI DAT drive can back up the Mac's hard disk, and 3) All PC's and Mac's can share the 600-DPI PostScript/PCL laser printer.

MacLan will run on just about any network protocol, including Ethernet, Token Ring, or LocalTalk (Apple's low-speed, proprietary network protocol built into every Mac). Internal and external LocalTalk port adapters are available for PC's. My network currently runs 10-Mbps Ethernet. MacLan is optimized to coexist with Microsoft's NDIS 3.0 drivers, but it can work with other drivers, including Novell/ODI.

The MacLan software comes on two diskettes, which contain an AppleTalk protocol stack and several utility programs. All the software installs on a Windows (3.x or 95) machine; the Mac is not modified at all. Each copy of MacLan is serialized, so you cannot run more than one copy of the program on a network. Under Windows 95, the basic installation copies files to the proper locations and updates several system initialization files. However, the user still has to manually add the AppleTalk protocol and Miramar's client software through the Windows 95 Network icon in the Control Panel. Doing so gives basic client services. Separate, external applications provide print (PIN.EXE) and file (PMACLAN.EXE) sharing services so that Macs can use files and printers on the PC. A third application (ASHAREXE.EXE) allows you to map Mac drives to local drive letters.

At this point, I might as well mention MacLan's limitations, the first of which is incomplete integration into Windows 95's networking architecture. Essentially, it provides Windows 3.1-style integration, in which network resources are—and must be—mapped to drive letters. The implications of this are three-fold.

First, you can't get to LocalTalk resources through the normal Windows 95 user interface (e.g., the Network Neighborhood). Second, only 8.3 (eight-character plus 3-character extension) filenames are supported (in both directions). So, although I was able to back up the Mac's hard drive, the backup is basically useless, because if need be, I would only be able to restore 8.3-character filenames, and the Mac would not be happy about that. Third is that although you can log on to Mac drives from a DOS box under Windows 95, you cannot map drives using NET USE commands. You have to use the ASHAREXE utility mentioned above, which limits the ability to create scripts (batch files) for automating things like backups. The workaround is to mark drive assignments as auto connect, so that they're remapped each time you boot. Another workaround is that until long file names are supported, Mac users must limit filenames to the 8.3 format.

One nice feature is that only one copy of MacLan Connect is required to share a printer among multiple PC's and Mac's. Also, the printer connection feature in MacLan Connect allows "virtual" connections to printers physically located on other servers. So on my network, my main machine runs all the MacLan software, even though the printer is physically attached to another machine. MacLan simply redirects print jobs from both that machine and the Mac to the print server.

Miramar is aware of the limitations of the current version, and is working on an update, although timing was not set as of this writing. The MacLan User's Manual is poorly done. Anyone with any networking experience should have no trouble, but I suspect beginners would be sorely confused. It was obviously written for a Win311 version of the product, and has only been superficially adapted for Windows 95.

All in all, it's a pretty strange feeling to be traipsing through the directory structure of a Mac from a DOS command line running under Windows 95 across a network. But it does work. Retail price for a single-

user copy is about \$130. Multi-user licenses are available.

## Remote Access

Another piece of the puzzle is remote access. I need a dial-in system so that employees, contractors, and clients can dial in to obtain files. I also need to be able to dial in when I'm on the road. When I dial in, I want all rights to the system, but when anyone else dials, that person should have very limited rights.

One initial attraction of Windows 95 had been its inclusion (via the Plus! Pack) of a simple Remote Access Services (RAS) server. When you dial in to a RAS server, you essentially become another node on the network. Your physical connection to the network does not occur via a 10-Mbps Ethernet adapter, but through the pair of connecting modems. Obviously then, things work a bit more slowly. But they do work.

The Windows 95 RAS mechanism appears in Dialup Networking, accessible through My Computer. After installing RAS, a new item appears on the Connections menu. Select Dialup Server, and a simple dialog box appears, allowing you to set a few basic parameters (on/off, password, server type). Then, whatever security constraints you've set up on that machine apply. See Chapter 28 of the *Microsoft Windows 95 Resource Kit* for detailed information on everything required to get a RAS server running.

Windows 95's RAS server works. You can connect to it from another Windows 95 machine, a Windows NT 3.5x machine, or a Windows for Workgroups machine. I don't believe there's any other way to connect. And that's what blew the W95 RAS server for me.

What I opted for instead is a simple BBS program, written in the scripting language of a DOS character-mode telecommunications program running as a task under Windows 95.

On my network, an old but not quite obsolete PS/2 Model 70 (386/25, 8MB) functions as a communications and print server. The telecommunications program is a shareware program called Commo. Commo is available on CompuServe

and directly from the author; in addition, I'll post a copy on the Gernsback BBS (516/293-2283, V.32bis). The "BBS" program runs in a DOS window automatically on boot via Win95's StartUp folder. The only thing that the BBS program doesn't do is provide a separate upload/download directory for each user, but that shouldn't be hard to code myself. It's only a question of making sure that I find the time to do it. For now, the default will suffice.

I'll continue this next time, with a discussion of remote access via LapLink for Windows 6.0b. We'll also talk about planned obsolescence (re HP's OmniBook 300), desktop PCMCIA adapters, and PCMCIA modem and network adapters. I'm also looking into disk-partitioning and boot-management tools (Partition Magic and System Commander), Windows Help development tools (HyperText Suite, Doc-To-Help, RoboHelp), Caldera's commercial Linux release, Visual Basic component software, C/C++ compilers, Web servers, Web page editors, Java, and more. If we get through all that by the end of the year, it'll be a miracle! Besides, there's bound to be a bunch of new stuff I don't even know about today.

### E-mail

David Brodbeck writes, "I found your column in the March issue of Electronics Now quite interesting. I find it disconcerting that the really innovative companies in the computer industry seem to get swept under by giants like Microsoft. It seems that any company capable of developing an innovative product is nearly always completely incapable of marketing it; witness Commodore and Apple. I fear Sun may be next."

Yup. Technical best does not automatically win.

Tom Decker asks, "Do you believe a big company exists that is smart enough to pick up Linux and package it for commercial release? This would be a low profit venture but the expenses of doing this would also be low. Possibly package a PC with Linux installed?"

Caldera is a company formed by Ray Noorda, formerly head of Novell.

## RESOURCES

**MacLan Connect**  
Miramar Systems, Inc.  
121 Gray Ave., #200B  
Santa Barbara, CA 93101  
(805) 966-2432

**Caldera**  
(800) 850-7779  
(801) 229-1675.

**Commo**  
Fred P. Brucker  
P.O. Box 141537  
Columbus, OH 43214

Caldera's release of Linux has gotten some excellent reviews in the trade press. I hope to take a look at it within the next few months. In the meantime, contact information appears in the resources box above.

Long-time readers may recognize the name Pete Stark, who has been educating the computing public about 68xxx microprocessor technology for this magazine, *Byte*, and others for more than 15 years. Pete and I are old friends.

Nonetheless he says, "I've been reading your columns for some time, and have been quite perturbed by them. I've noticed your frequent pronouncements of how Microsoft is winning the software wars. Not only does this disturbing, as I routinely root for the underdog, but I am beginning to think that your articles, and those of other authors and editors, are a self-fulfilling prophecy.

It bothers me an awful lot that your articles may in fact be contributing to the hegemony that Microsoft is trying to achieve. I do wish that you would point out the dangers more often of a single company so profoundly controlling the entire industry."

As I told Pete, I don't really think the complaint is justified. Nonetheless, Pete, here it is: Competition is good! Monopoly is dangerous! Examine all viable alternatives before making serious purchase decisions. Many voters these days do not really vote for particular candidates, but against others. Perhaps the same type of attitude is appropriate when purchasing computer products.

Let me know what you think:  
jkh@acm.org.

## Find the Right Electronic Component Fast



### D.A.T.A./P/A/L™ D.A.T.A. Parametric Access Library

This PC-based CD-ROM reference offers fast, easy access to over 1.6 million current and discontinued ICs and discrete semiconductors. Custom configured to your specifications, D.A.T.A./P/A/L provides up to 25 parametric values and references over 1,100 component manufacturers. (Prices start at \$360/Category)



A Division of Information Handling Services Inc.

**D.A.T.A. Business Publishing**  
tel: 800-447-4666 Ext. EPG-B  
303-799-0381 Ext. EPG-B  
fax: 303-799-4082  
data.product.management@ihs.com

CIRCLE 180 ON FREE INFORMATION CARD

## ANTIQUE RADIO CLASSIFIED Free Sample!

Antique Radio's Largest Circulation Monthly. Articles, Ads & Classifieds.   
6-Month Trial: \$17.95. 1-Yr: \$34.95 (\$51.95-1st Class).  
A.R.C., P.O. Box 802-L15, Carlisle, MA 01741  
Phone:(508) 371-0512 VISA/MC Fax:(508) 371-7129

## CABLE CONVERTER DIAGNOSTIC TEST CHIP

**LOAD FULL ACTIVATION OF CABLE CONVERTER**  
WE STOCK A COMPLETE LINE OF CHIPS, TOOLS, WIRELESS QUICK INSTALL TEST BOARDS AND DIAGNOSTIC CUBES FOR ALL CONVERTERS!  
\*\*\* ANYONE IMPLYING ILLEGAL USE WILL BE DENIED SALE. WE SELL PRODUCTS ONLY TO TECHNICIANS OR CABLE REPAIR FACILITIES!  
#1 IN CUSTOMER SERVICE & TECH. SUPPORT!  
\*ALL ORDERS SHIP WITHIN 24HRS, UPS/ FED-X.  
\*PRIORITY NEXT DAY SHIPPING AVAILABLE!  
\*SALE= BUY 5 BOARDS GET 1 FREE TILL MAY96.  
\*LOWEST PRICE & SUPERIOR PRODUCT GUAR!!  
\*FRIENDLY COURTEOUS SERVICE. WE'RE PRO'S  
 **VISUAL**  
**COMMUNICATIONS INC.**  
FOR ORDERS 1-800-GO-CABLE  
CATALOG & TECH. SUPPORT 717-620-4363 EST. 1977

# RETAILERS THAT SELL OUR MAGAZINE MONTHLY

## Alaska

Frigid North Co.  
1207 W. 36th Avenue  
Anchorage, AK 99503

## Arizona

Dalis Electronics  
2829 E. McDowell Road  
Phoenix, AZ 85008

## California

California Electronics  
221 N. Johnson Ave.  
El Cajon, CA 90202

Signal Electronics  
22307 Ocean Avenue  
Torrance, CA 90505

Ford Electronics  
8431 Commonwealth Avenue  
Buena Park, CA 90621

All Electronics  
14928 Oxnard Street  
Van Nuys, CA 91411

Gateway Electronics of CA  
9222 Chesapeake Drive  
San Diego, CA 92123

Mac's Electronics  
191 South "E" Street  
San Bernardino, CA 92401

Electronics Warehouse  
2691 Main Street  
Riverside, CA 92501

Orvac Electronics  
1645 E Orangethorpe Ave.  
Fullerton, CA 92631

Sav-On Electronics  
13225 Harbor Blvd.  
Garden Grove, CA 92643

Marvac Dow Electronics  
980 S. A Street  
Oxnard, CA 93030

Kandarian Electronics  
1101 19th Street  
Bakersfield, CA 93301

Whitcomm Electronics  
105 W. Dakota #106  
Clovia, CA 93612

Marvac Dow Electronics  
265-B Reservation Road  
Marina, CA 93933

Minuteman Electronics  
37111 Post St., Suite 1  
Fremont, CA 94536

HCS Electronics  
6819 S. Redwood Drive  
Cotati, CA 94931

Halted Specialties Co.  
3500 Ryder Street  
Santa Clara, CA 95051

Metro Electronics  
1831 J Street  
Sacramento, CA 95814

The Radio Place, Inc.  
5675-A Power Inn Road  
Sacramento, CA 95824

HSC Electronics  
4837 Amber Lane  
Sacramento, CA 95841

## Colorado

Gateway Electronics of CO  
2525 Federal Blvd.  
Denver, CO 80211

Centennial Electronics  
2324 E. Bijou  
Colorado Sps., CO 80909

## Connecticut

Signal Electronics Supply  
589 New Park Avenue  
W. Hartford, CT 06110

Cables & Connectors  
2198 Berlin Turnpike  
Newington, CT 06111

Electronic Service Prod.  
437 Washington Avenue  
North Haven, CT 06473

## Georgia

Norman's Electronics, Inc.  
3653 Clairmont Road  
Chamblee, GA 30341

## Idaho

The Current Source  
5159 Glenwood  
Boise, ID 83714

## Illinois

Tri State Elex  
200 W. Northwest Hwy.  
Mt. Prospect, IL 60056

## Maryland

Mark Elec. Supply Inc.  
5015 Herzel Place  
Beltsville, MD 20705

Amateur Radio Center  
1117 West 36th Street  
Baltimore, MD 21211

## Massachusetts

U-Do-It Electronics  
40 Franklin Street  
Needham, MA 02194

## Michigan

Purchase Radio Supply  
327 East Hoover Avenue  
Ann Arbor, MI 48104

Norwest Electronics  
33760 Plymouth Road  
Livonia, MI 48150

The Elec. Connection  
37387 Ford Road  
Westland, MI 48185

Elec. Parts Specialists  
711 Kelso Street  
Flint, MI 48506

Professional Data Corp.  
1332 US Highway 41 West  
Ishpeming, MI 49849

## Minnesota

Acme Electronics  
224 Washington Avenue N.  
Minneapolis, MN 55401

## Missouri

Gateway Electronics Of MO  
8123-25 Page Blvd.  
St. Louis, MO 63130

## New Jersey

Lashen Electronics Inc.  
21 Broadway  
Denville, NJ 07834

## New York

Sylvan Wellington Co.  
269 Canal Street  
New York, NY 10013

R&E Electronics  
4991 Rt. 209  
Accord, NY 12404

Unicom Electronics  
Valley Plaza  
Johnson City, NY 13790

## Ohio

Philcap Electronic Suppliers  
275 E. Market Street  
Akron, OH 44308

## Oregon

Norvac Electronics  
7940 SW Nimbus Avenue  
Beaverton, OR 97005

## Pennsylvania

Business & Computer Bookstore  
213 N. Easton Road  
Willow Grove, PA 19099

## Texas

Mouser Electronics  
2401 Hwy. 287 N  
Mansfield, TX 76063

Electronic Parts Outlet  
17318 Highway 3  
Webster, TX 77598

## Washington

Amateur Radio Supply Co.  
5963 Corson Ave., Ste 140  
Seattle, WA 98108

## Wyoming

Chris Supply  
2007 S. Douglas Hwy., Ste. C  
Gillette, WY 82716

**If you'd like to sell our magazine in your store,  
please circle 210 on Free Information Card.**

NEIL HECKT

COMMUNICATIONS ENGINEERS, experimenters and technicians working with RF filters, oscillators and amplifiers need an instrument to accurately measure small values of inductors and capacitors. The instrument presented here will fill the bill perfectly.

The L/C (inductance/capacitance) meter features a measurement range of 0.001 to 100 microhenrys ( $\mu\text{H}$ ) and 0.010 picofarads (pF) to 1 microfarad ( $\mu\text{F}$ ).

The meter automatically selects the proper range, and provides a worst-case accuracy of 3% of reading, and a resolution of four digits. The measurements are displayed on a 16-character intelligent LCD. The meter's sampling rate is about four samples per second.

#### Circuit description

The heart of the L/C meter is the oscillator circuit on the left side of the schematic in Fig. 1. The oscillator's function can best be visualized by assuming that the output of the LM311 voltage comparator is a square wave at the resonant frequency of the tank circuit formed by L1 and C1. The square wave is applied to the tank circuit through R3 and AC-coupling capacitor C3. The tank circuit filters out the fundamental sine wave, which is then applied to the input of the voltage comparator and causes a square wave to be generated at its output, thus sustaining oscillation.

When power is first applied, the voltage at pin 2 of the LM311 quickly builds up to one half of the supply voltage through the voltage divider formed by R1 and R2. This causes the output, pin 7, to be at a high level equal to the supply voltage. This high level output charges C4 via R4 until the voltage at pin 3 is equal to the voltage at pin 2. The output then switches to a low level, introducing a transient in the tank circuit that causes it to ring at its resonant frequency. This ringing is turned into a square wave at the resonant frequency of the tank at the output

# Build this self-calibrating L/C METER

**This microcontroller-based digital inductance and capacitance meter is self-calibrating.**

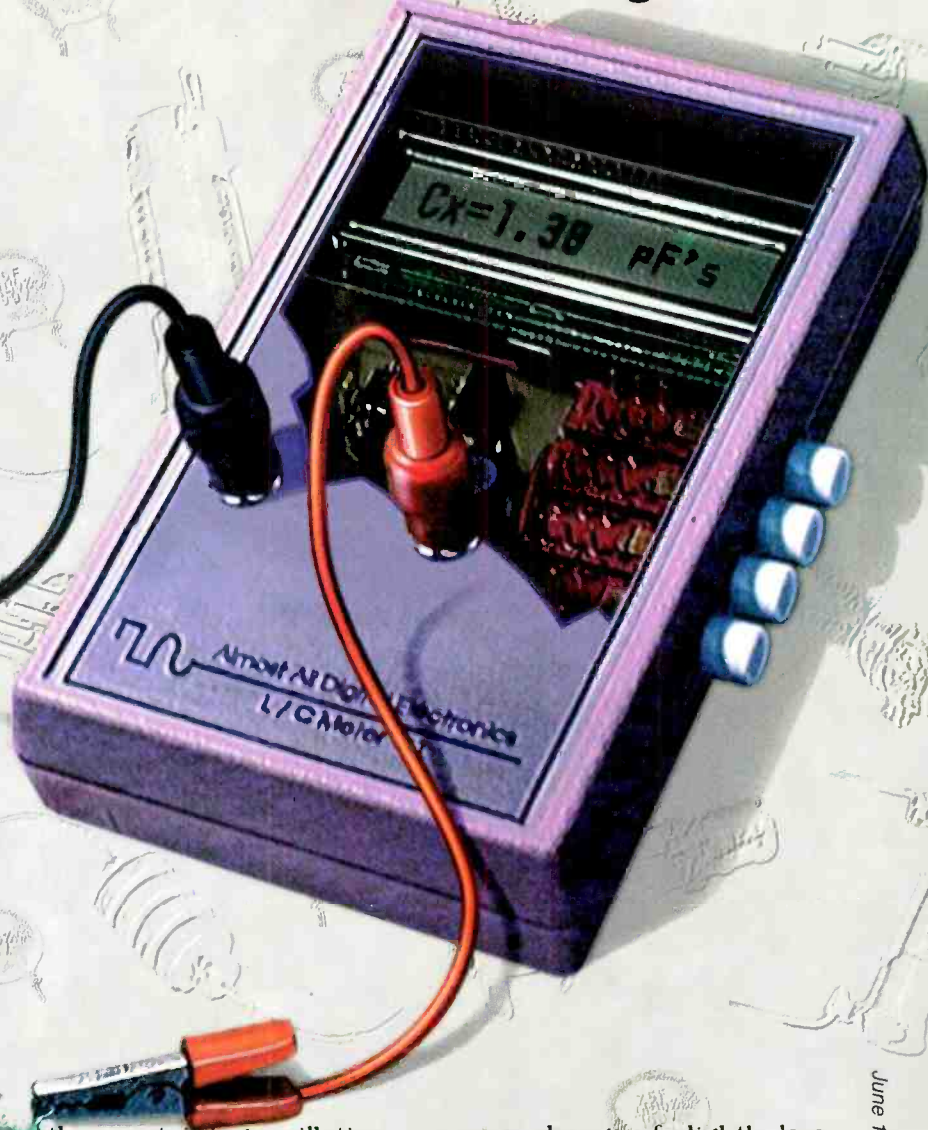

pin, thus sustaining oscillation as described above. The square wave will have a 50% duty cycle causing C5 to remain charged to a voltage equal to that of pin 2.

The nominal values of L1 (68  $\mu\text{H}$ ) and C1 (680 pF) were chosen because an increase in L of 1 nH (.001  $\mu\text{H}$ ) produces a fre-

quency change of slightly less than 5 Hz. The 0.2-second measuring period can resolve 5 Hz and therefore 0.001  $\mu\text{H}$ .

Besides being simple, this oscillator circuit is very reliable. It always starts, and it can tolerate a large variation in the inductances and capacitances used in the tank circuit. The range of

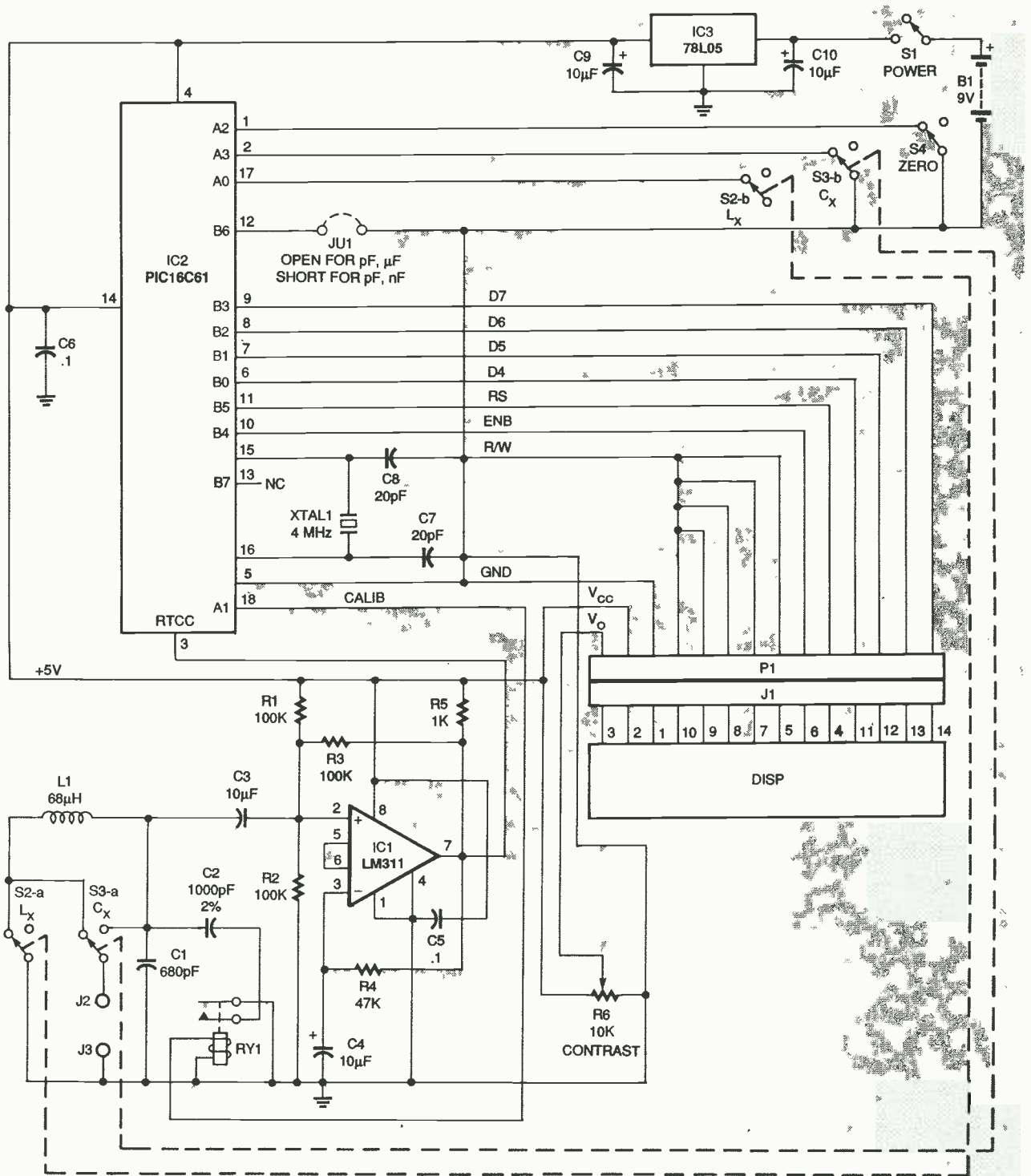

FIG. 1—THE L/C METER SCHEMATIC. The oscillator built around IC1 is the heart of the circuit. IC2, a PIC16C61 microcontroller, is its brains.

inductance and capacitance is limited by the amplitude of the sine wave voltage across the tank circuit. The minimum peak-to-peak voltage is equal to the offset voltage specification of the LM311—about 2 to 10 millivolts. The maximum peak-to-

peak voltage is limited to about half the supply voltage, 2.5 volts. These voltage limits can be translated to inductance and capacitance limits in the simplified equivalent circuit of a parallel resonant tank shown in Fig. 2.

The resistor R is normally part of the inductor and is caused by the resistance of the wire from which it is wound. The maximum impedance of the parallel resonant tank is:

$$Z_{\max} = Q\sqrt{LC}$$

where  $Q = 2\pi fL/R$ .

Continued on page 61



William Sheets, K2MQJ and Rudolf F. Graf, KA2CWL

**Pull in ATV transmissions  
on the 900 MHz and  
1300 MHz bands**

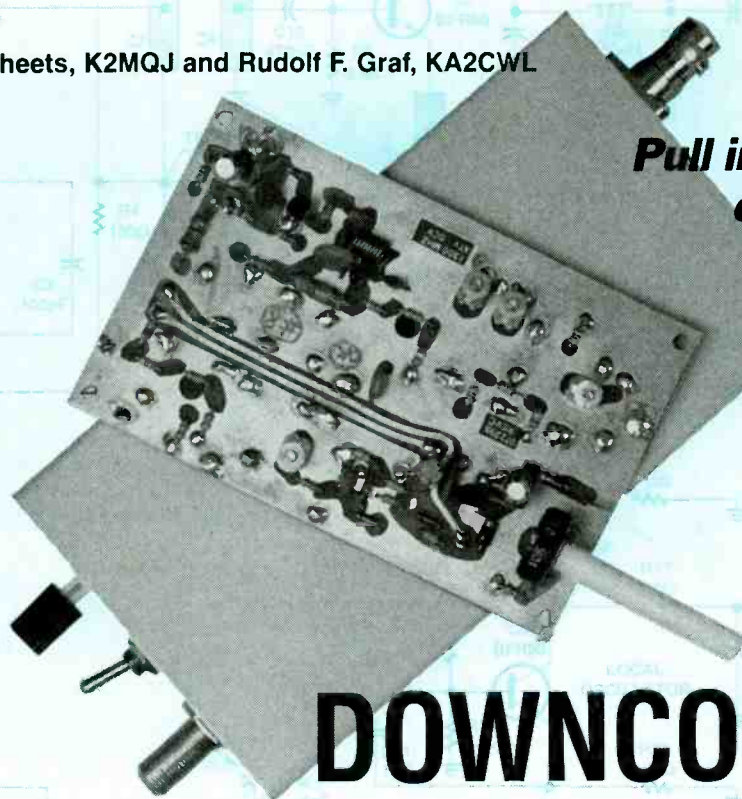

# BUILD THIS UHF DOWNCONVERTER

THE MINIATURE, TUNEABLE UHF downconverter described in this article is designed to receive amateur television (ATV) signals in the 900–1300-MHz band and convert them for display on an ordinary TV set. The downconverter is the perfect match for the 900-MHz ATV transmitter described in last month's issue of *Electronics Now*. It is also used to receive signals from low-powered video links operating in the 900 (33-centimeter) band.

As a bonus, a design for 1300 MHz downconverter is also presented to allow reception of any ATV activity in the 23-centimeter (1240-1300 MHz) amateur band. Both the 900-MHz and 1300-MHz converters are mechanically nearly identical and appear the same unless inspected closely. They differ slightly with regard to the PC board microstrip tuned elements and minor difference in the local oscillator circuit. Otherwise the same circuit architecture and parts are used for both. Their theory of operation and construction are closely

paralleled. In the discussion that follows, reference is made only to the 900-MHz unit unless differences between the two units are noted.

The downconverter is not intended for reception of narrow-band FM or SSB signals since the converter uses a tuneable local oscillator covering a 30 to 60 MHz range. The 900-MHz and 1300-MHz versions are useable for wide-band modes such as AMTV, FMTV or FM audio reception using a conventional FM broadcast receiver tuned to 90 MHz or so on the dial.

### Basic signal flow

The downconverter block diagram is shown in Fig. 1. Signals from the RF input are fed to low-noise RF amplifier Q1, which boosts the antenna signal and feeds it to mixer transistor Q2. There the amplified signal is mixed with the output of the tuneable voltage-controlled local oscillator Q5 to an intermediate frequency (IF) of 60 MHz. The IF signal is fed from the mixer to an IF pre-amplifier stage.

Three tuned circuits, Z1-Z4, are used in the RF amplifier stage. These are not discrete components—they are of PC board stripline construction, and consist only of circuit-board traces. Other tuned stripline circuits, Z5-Z6 are also used in the downconverter.

Voltage-controlled oscillator Q5 is tuned by a DC voltage. This DC voltage can be selected from either a PC board potentiometer or via an external, coaxial-fed power supply that allows the downconverter to be tuned remotely. This arrangement enables the downconverter to be mounted on the right at the antenna feed point to eliminate feed-line losses that are significant at this frequency range. No separate DC feed is necessary since the coax (RG59/U or RG6/U recommended) carries both DC power, tuning voltage and IF signal.

The downconverter's input impedance is 50 ohms, and any matching 900-MHz or 1300-MHz antenna can be used. The overall gain of the downconverter is about 37-43 dB. The

# Get 3 books for only \$9.95 Plus 1 book FREE upon prepayment

when you join the **Electronics Engineers' Book Club®**

Values to \$230.00

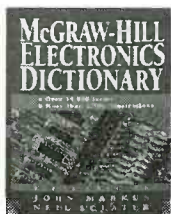

**0404348-XX \$49.50**  
More than 14,000 entries and 1,500 illustrations make up this A-to-Z reference. Its up-to-date definitions cannot be found in general dictionaries. Plus, it focuses on terminology specific to the field of electronics. 608 pp., 1,500 illus.  
*Counts as 2*

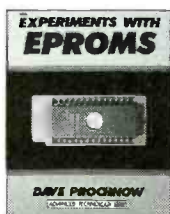

**156490X \$18.95**  
This complete EPROM instruction manual provides a detailed explanation of underlying theory, plus 15 different projects—including programmers, erasers, and EPROM-based circuits. 240 pp., Softcover.



**0240620 \$45.00**  
Examine all aspects of radar, from its history and development, through components and theory, to installation, maintenance, and repair techniques for the technician with this book. Topics covered include transmitters, modulation techniques, Rf generators, waveguides, antennas, receivers, MTI Theory of Operations, and more. 304 pp., 232 illus., Hardcover.

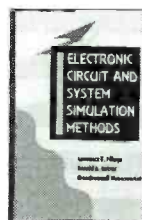

**0501696 \$55.00**  
Develop sophisticated electronic simulation tools capable of analyzing large, complicated circuits. This book describes a broad range of uses for circuit simulation principles—from running general applications to understanding why SPICE works in some cases and not in others. 320 pp., Illustrated.

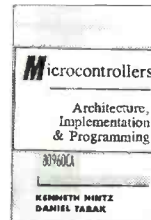

**0289778-XX \$52.00**  
Unleash the power of controllers with this guide. You'll see how a controller can be used in anti-lock brakes, cash registers, and robotic systems. You get details on controllers such as the Motorola 8-bit MC68HC11, and the 32-bit Intel 8051 and 80960CA to help you use devices in your projects. 350 pp., 125 illus.  
*Counts as 2*

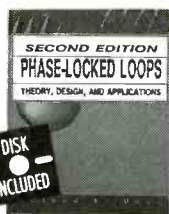

**9113869-XX \$55.00**  
Develop the expertise to design the most efficient phase-locked loops for all kinds of electronic devices. You'll find design and applications information for all four types of PLLs: linear, digital (an analog/digital hybrid), all-digital, and software. 370 pp., 100 illus.  
*Counts as 2*

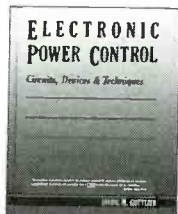

**0239193 \$27.95**  
This practical guide focuses on the specific digital circuits used in electronic power applications. It presents state-of-the-art approaches to analysis, troubleshooting, and implementation of new solid-state devices. 272 pp., 197 illus., Hardcover.



**0326924-XX \$45.00**  
Put LabVIEW to work solving your specific instrumentation problems on all platforms available to LabVIEW: PC/Windows, Macintosh, and Sun SPARCstation. The book outlines a logical analysis methodology, detailing how to define each problem and how to establish a solution and design technique. 546 pp., Illustrated.  
*Counts as 2*



**0380899-XX \$60.00**  
Find a complete technical description of the design, analysis, and maintenance of cellular systems in the second edition of this classic reference. It features new chapters on the CDMA standard, microcell systems, digital cellular systems, and more. 550 pp., 170 illus.  
*Counts as 2*



**0704414-XX \$79.50**  
Still the number one resource for designers in the field, the third edition of this classic handbook has been extensively revised and updated to reflect the enormous recent advances in electronic filter design... while maintaining the overall emphasis on practicality that made prior editions so appealing. 704 pp., 220 illus.  
*Counts as 2*

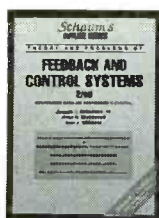

**0170479 \$14.95**  
Examine control systems terminology, differential equations, the Laplace transform, the Z-Transform, block diagram algebra, transfer functions of systems, signal flow graphs, systems sensitivity measures, classification of feedback systems, and more. 400 pp., Softcover.



**0415250-XX \$66.34**  
Gain a firm understanding of the fundamentals of control theory with this authoritative guide. Coverage includes: modeling uncertainty in the frequency domain, robust stability, robust performance, controllability and general pole placement, and pole placement techniques using transfer functions and the Diophantine Equation. 572 pp., Illustrated, *Counts as 2*

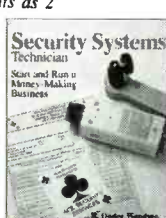

**0717753 \$19.95**  
Become self-employed as a security systems contractor—this book shows you how. Woodson helps you decide whether you are cut out to run your own business and covers every aspect, from start-up capital to collecting past-due accounts. 304 pp., 150 illus., Softcover.

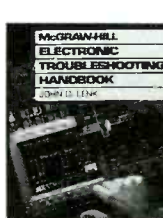

**0376581 \$39.50**  
Pinpoint component faults and correct design flaws for virtually every type of electronic circuit with this handbook. Both circuit theory and step-by-step troubleshooting techniques are given for each circuit or component. All kinds of electronic circuits and basic components are covered as well as complete coverage of electronic equipment. 350 pp., 200 illus.



**0209820-XXX \$105.50**  
"Outstanding, extensive reference to current technology of electronics. Covers everything from principles to applications."  
—Computer Book Review  
2,528 pp., 1,800 illus.  
*Counts as 3*



**0628432-XX \$60.00**  
Keep up with the changes in top-level microprocessors with this newly revised edition. It covers the latest high-potential systems, such as Pentium, PowerPC, DEC Alpha, SuperSPARC, and others. 580 pp., 155 illus. Counts as 2

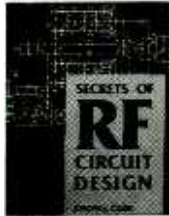

**0100926 \$24.95**  
Understand the basics of receiver operation, the proper use and repair components in RF circuits, and principles of radio signal propagation from low frequencies—all with this guide. 416 pp., 411 illus., Softcover.



**0042144 \$39.00**  
This book provides a solid introduction to programmable controllers. You'll explore how to use personal computers with programmable controllers as well as how to compare and select process control schemes. 304 pp., 180 illus.

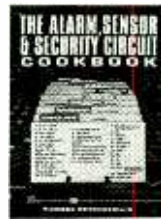

**0497060 \$29.95**  
Construct sophisticated security, convenience, and entertainment devices with this guide. You'll find schematics, photos, and instructions for building temperature and pressure sensors, smoke and toxic gas detectors, a remote video control system, door and window alarms, motion and impact detectors, and more! 304 pp., 232 illus.

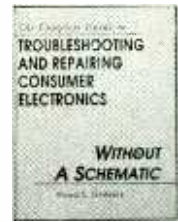

**0156492 \$34.95**  
Tackle troublesome circuits without the benefit of a schematic with these tricks of the trade by a veteran electronics technician. You'll see how to locate, test, and repair defective components in virtually every type of consumer electronics device imaginable. 304 pp., 250 illus.



**9119018 \$32.95**  
Turn your repair skills into profit with this guide. It offers information on everything from computer parts and tools to pricing and advertising. It covers areas of specialization, profiles auxiliary services, and even predicts future opportunities. The shareware disk packaged with the book includes a collection of diagnostic tools. 352 pp., 63 illus., Softcover.



**911525X \$50.00**  
Packed with sample circuit simulations that clearly illustrate a variety of common problems and their solutions, this in-depth guide shows you step by step how to deal with the stumbling blocks of nonconvergence, numeric integration instabilities, and timestep control errors. 208 pp., 200 illus.



**0043017 \$50.00**  
Covering both analog and digital cellular systems, this book provides complete coverage of the principles and design techniques for cellular systems. Gain a firm understanding of some of the most advanced person-to-person communications systems being installed today with this comprehensive look at modern cellular technology. 224 pp., 142 illus.

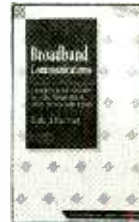

**0359687 \$65.00**  
Keep up on the standards, services, architectures, applications, markets, and key players with this reference. It emphasizes the asynchronous transfer mode (ATM) technology, its protocol, and its switching and working environment. It also details upcoming technologies such as FDDI, DQDB, Frame Relay, SMDS, and SONET. 544 pp., 300 illus.



**0523746-XX \$55.00**  
This book provides an in-depth look at the basics of designing the elements and components that comprise a satellite communication system, including the geosynchronous satellites prevalent in mobile communications. 400 pp., 120 illus. Counts as 2

## As a member of the Electronics Engineers' Book Club...

... you'll enjoy receiving Club bulletins every 3-4 weeks that contain exciting offers on the latest books in the field—at savings up to 50% off regular publishers' prices. If you want the Main selection, do nothing and it will be shipped automatically. If you want another book, or no book at all, simply return the reply form to us by the date specified. You'll have at least 10 days to decide. If you ever receive a book you don't want due to late delivery of the bulletin, you can return it at our expense. Plus, you'll be eligible for **FREE books** through the Bonus Book Program. Your only obligation is to purchase 3 more books during the next 2 years, after which you may cancel your membership at any time.

All books are hardcover unless otherwise noted. Publishers' prices shown. If you select a book that counts as 2 choices, write the book number in one box and XX in the next. If you select a counts as 3 choice, write the book number in one box and XXX in the next 2 boxes. A shipping/handling charge & sales tax will be added to all orders. ©1996 EEBC

If card is missing, write to: Electronics Engineers' Book Club  
A Division of The McGraw-Hill Companies  
P.O. Box 549, Blacklick, OH 43004-9918



**Phone: 1-614-759-3666**  
(8:30 a.m. to 5:00 p.m. EST Monday-Friday)



**FAX: 1-614-759-3749**  
(24 hours a day, 7 days a week)

## ELECTRONICS ENGINEERS' BOOK CLUB

A Division of The McGraw-Hill Companies, P.O. Box 549, Blacklick, OH 43004-9918

**YES!** Rush me the following title(s), billing me just \$9.95 (plus shipping/handling & sales tax). Enroll me as a member of the Electronics Engineers' Book Club according to the terms outlined in this ad. If not satisfied, I may return the book(s) within 10 days for a full refund and my membership will be cancelled. I agree to purchase just 3 more selections at regular Club prices during the next 2 years and may resign anytime thereafter.

Bill me (FREE book not available with this payment option.)

Code #'s of my book(s) for \$9.95

--	--	--	--

If you select a book that counts as 2 choices, write the book number in one box and XX in the next.  
If you select a counts as 3 choice, write the book number in one box and XXX in the next 2 boxes.

**SPECIAL OFFER!** Prepay your order by check, money order, or credit card and receive a 4th book of your choice FREE.

**YES!** I want the FREE BOOK indicated at right. My introductory payment of \$9.95 plus \$9.95 shipping/handling\* and applicable sales tax is enclosed.

Code # of my FREE BOOK:

SINGLE SELECTION ONLY

Check or money order enclosed made payable to: The McGraw-Hill Companies  
Please charge my:  VISA  MasterCard  American Express  Discover

Acct. No. \_\_\_\_\_ Exp. Date \_\_\_\_\_

Name \_\_\_\_\_ Signature \_\_\_\_\_  
(required on all orders)

Address / Apt. # \_\_\_\_\_

City/State/Zip \_\_\_\_\_ Phone \_\_\_\_\_

Offer valid for new members only, subject to acceptance by EEBC. U.S. orders are shipped 4th Class Book Post. Canada must remit in U.S. funds drawn on U.S. banks. \*Canadian orders are shipped International Book Post—add \$12.50 shipping/handling. Applicants outside the U.S. and Canada will receive special ordering instructions. A shipping/handling charge & sales tax will be added to all orders.

DRE696C

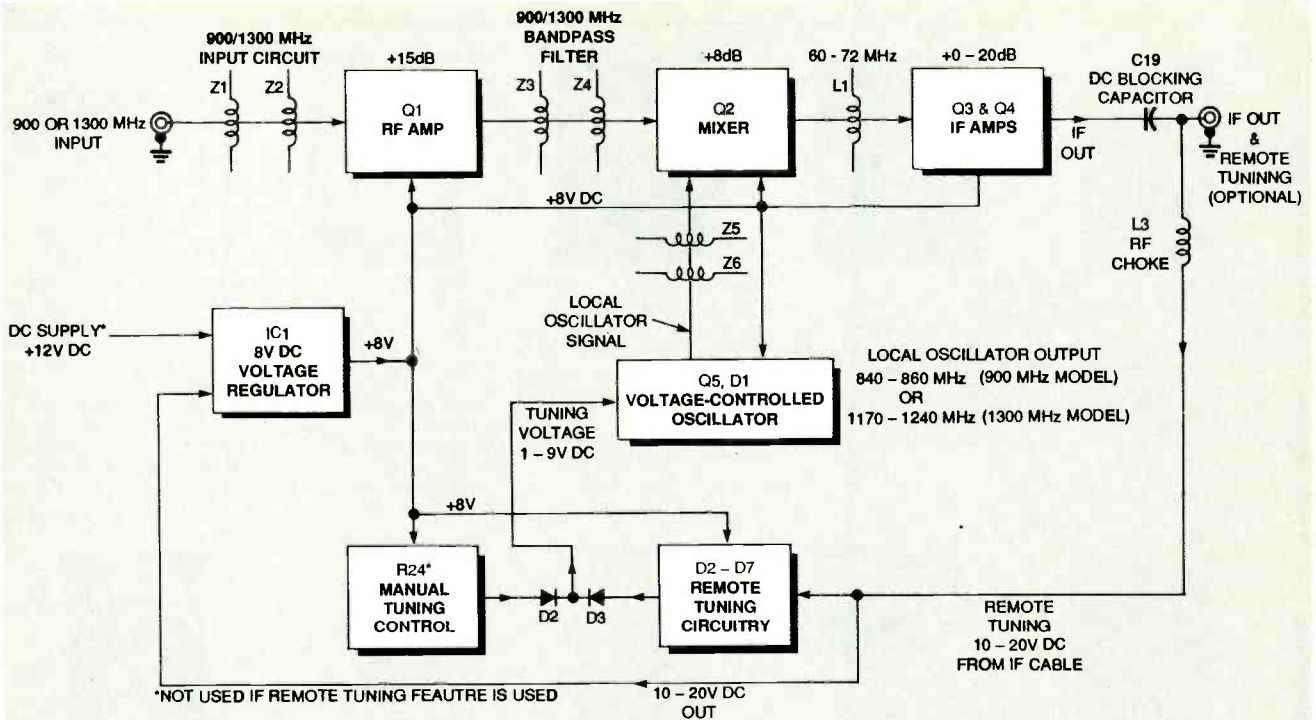

FIG. 1—BLOCK DIAGRAM for the downconverter serves for both the 900 and 1300-MHz versions.

gain can be changed as needed by changing a resistor value.

For portable operation or for use in a packaged ATV transceiver or a video handy talky (HT), the on-board tuning potentiometer may be used. The tuning voltage is tapped from the +8-volt DC voltage-regulator, IC1.

For on-board tuning, the external power supply must deliver a fixed 11 to 20 volts DC at approximately 30 milliamperes to the 8-volt DC regulator. For remote tuning, the supply must be variable.

### Circuit operation

The downconverter schematic is shown in Fig. 2. The input signal from antenna jack J1 is fed to a filter made up of Z1, C1, and Z2. Microstrip lines Z1 and Z2 are part of the PC board foil surface and form a tuning circuit. (All six microstrip lines are given Z designations.) Trimmer capacitor C1 is adjusted for best reception of a weak signal. The signal is then fed to gate G1 of Q1. Transistor Q1 is a low-noise MESFET with a noise figure about 1 dB. Unavoidable circuit losses will raise the actual noise figure to typically 1.5 to 2

dB, which is fairly good for the intended application. The source S of Q1 is biased by R1. The other gate, G2, is biased by R2 and R3. Two pairs of 100-pF capacitors (C2 through C5) bypass both the source and G2 of Q1 to ground, providing the necessary bypassing for inductance Z3. Chip capacitors were chosen for C2-C5 because conventional 100-pF disc capacitors function poorly at 900 or 1300 MHz.

The amplified signal at the drain of Q1 is fed to a double-tuned coupling network consisting of Z3, C8, Z4, and C9. Trimmer capacitors C8 and C9 determine the bandpass characteristics of the network. Capacitors C6 and C7 provide RF grounding for the low end of Z4. The spacing of Z3 and Z4 on the PC board determines the amount of RF mutual coupling. This amount is fixed by the PC etched layout. The RF gain of the stage is about 12 to 15 dB. This gain figure is a net number that includes losses in the input and output tuned-circuit networks, and between the antenna input and the mixer input.

Transistor Q2 serves as a RF mixer. The bipolar transistor is

biased by R5, R6, R7, R8, and a chip resistor network that consists of R14, R15 and R16. The mixer's emitter current is typically 1 milliampere.

The amplified RF signal from Q1 is fed via capacitor C10 to the base of Q2. The local oscillator's output signal is fed from Q5 to the emitter of Q2 via microstrip feedline Z5, R14, R15, and R16. Capacitor C13 provides a low impedance at the IF frequency (61.25 or 66.25 MHz) for the emitter of Q2. The local oscillator frequency is equal to the received RF signal *minus* the IF (low side). The signal gain from the mixer circuit is typically 6 to 8 dB. Overall gain so far is typically 20 dB.

The IF signal from the mixer is fed to a matching network consisting of C11, C12, L1, L2, and C14. The matching network rejects mixer-output signals above 100 MHz. The desired signal is then fed to an IF amplifier stage consisting of Q3 and Q4. Resistor R10 provides bias voltage while R9 provides termination for the matching network. Capacitor C16 blocks DC to the base of Q3. Current gain for the matching network is set by R11 and R12. Overall IF gain is about 20 dB.

*Continued on page 67*

LAWRENCE PICKENS

*Budget project  
zaps house, stable  
and blow flies  
with a mini-bolt  
of lightning.*

# SOLAR- POWERED FLY CONTROLLER

FLIES ARE A GREAT ANNOYANCE AND a health problem for man and beast. Flies breed in garbage cans, dumpsters, compost piles, and kennels, just to name a few sites. Most common solutions to eliminate flies have their own problems. For example, chemical insecticide sprays can be applied to surfaces, and poisoned fly bait can be spread around the garbage cans, but both are environmentally unsafe, and they are not effective against every species of fly. Also, the poisons must be re-applied at regular intervals, compounding the pollution problem.

What is needed to keep the fly population down at breeding sites is a continuously working device that is environmentally safe; effective against house flies, stable flies and blow flies; and that requires limited maintenance. The Solar-Powered Fly Controller presented here is an effective fly-zapping device that you can build. It has a high-voltage electric grid that electrocutes flies that alight on it. Its advantage over commercial electric flying-insect traps is that it is driven by battery or solar power. Commercial units are powered by line current and are unsuited for use in backyards or other outdoor areas that are remote from power lines.

The controller's circuit is turned on or off either manually or automatically. A photoelectric cell automatically turns the controller off at night and during dense cloud cover that usually brings rain.

The controller remains in the off state until the ambient light is sufficient to cause the unit's phototransistor to restore power to the controller. The controller provides high-voltage pulses at one or two-second intervals in order to conserve battery life. The solar power feature provides power to drive the controller and keep the battery in an excellent charge state. The controller develops a peak-to-peak, high voltage of at least 3,000 volts that can jump across a 3-mm gap when a fly

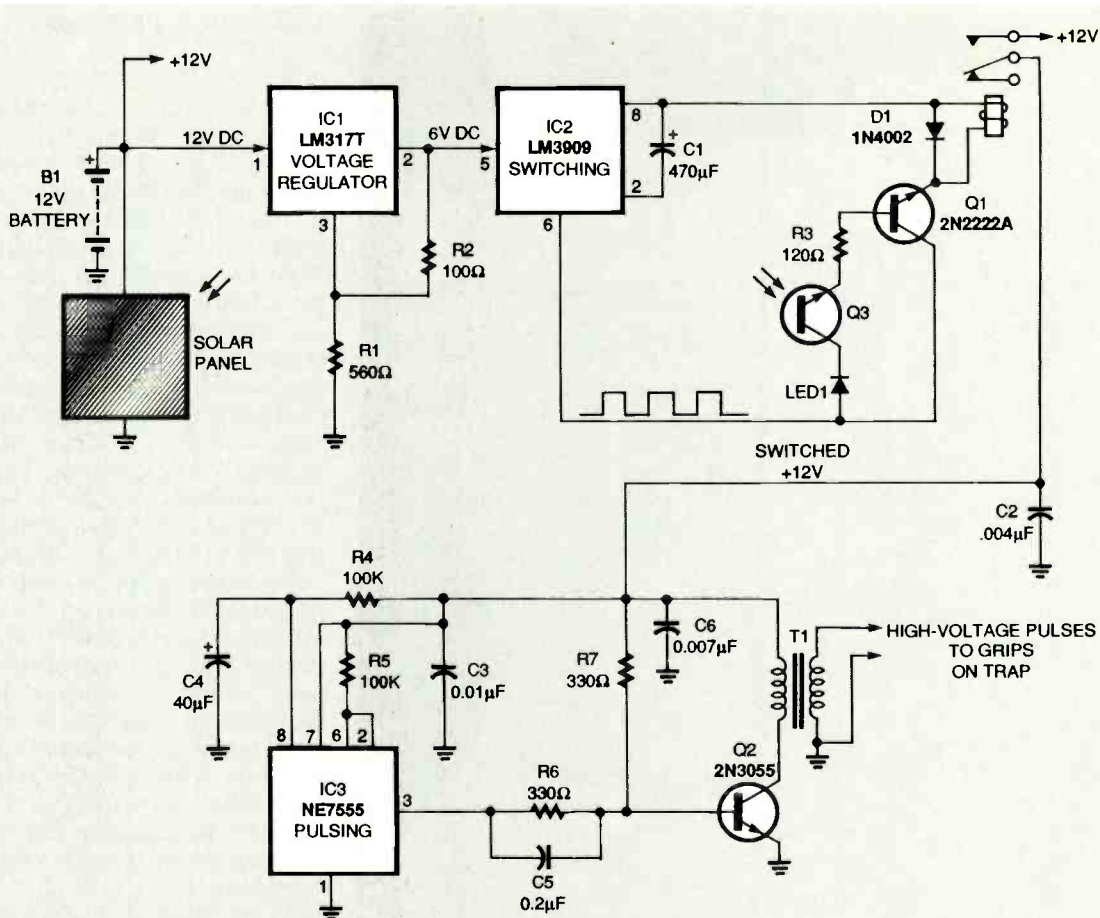

FIG. 1—SCHEMATIC DIAGRAM of the solar-powered fly controller is surprisingly simple.

alights in the gap. The high-voltage discharge current is below 8 mA which is considered safe for humans. Nevertheless, it is wise for humans to stay clear of the grid because an accidental shock may cause a person to involuntarily jump or slip into an obstacle and injure themselves.

### The circuit

The circuit for the solar-powered fly controller is shown in Fig. 1. It consists of a switching circuit, pulsing circuit, and a high-voltage output circuit. The external power components are a 1- to 5-watt solar panel and a 12-volt motorcycle or camcorder battery. The output of the high-voltage ignition coil connects to a network of paralleled electrodes, called a grid, upon which flies land and are destroyed.

Voltage input to the LM3909 LED-flasher/oscillator (IC2) is kept at 6 to 9-volts by a LM317T

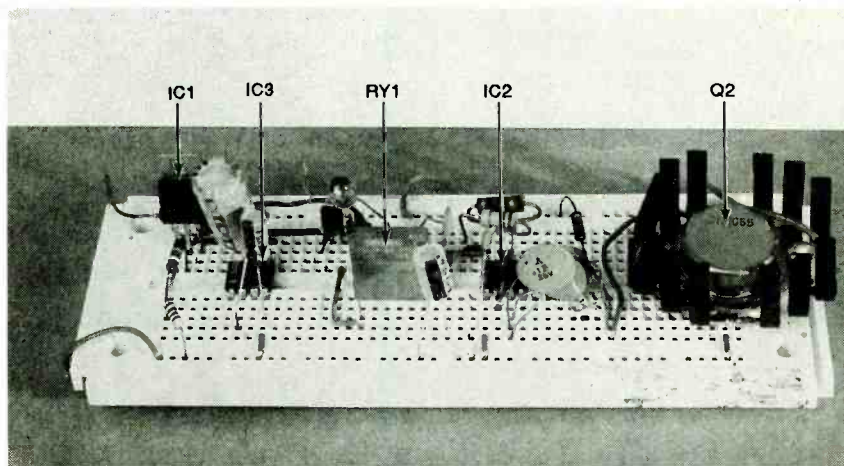

FIG. 2—PARTS PLACEMENT for the Solar-Powered Fly Controller is not critical. The ignition coil, T1, grids, and power source are located off the circuit board. Once the circuit is tested and functioning normally, move part by part to a matching PC board and solder in place.

voltage regulator (IC1). The exact voltage is not critical as long as it is regulated. The LM3909 produces a series of pulses that are coupled to a 2N2222A transistor (Q1) to form a switching circuit. An output of positive

pulses from IC2 to the 2N2222A transistor boosts the pulse current so that it closes a 5-volt relay (RY1) for approximately 0.1 second at intervals of 1 to 2 seconds. Diode D1 shunts out

*Continued on page 77*

# Troubleshooting For BOATERS

**Safety first and electrical maintenance go hand-in-hand  
to safeguard boating pleasure**

THIS ARTICLE IS DIRECTED TOWARD boating enthusiasts with an interest in maintaining their craft's electrical and electronic equipment. It will show you how to test and troubleshoot marine electrical systems, outboard motor magneto ignitions, and the integrity of your boat's corrosion protection system.

The marine environment can be especially harsh on the components of your boat's electrical system. When performing preventative maintenance or when trouble occurs, you will want the capability to make accurate and reliable electrical measurements quickly. The basic tool for this job is the digital multimeter.

## Work safety

The voltages and currents present in electrical power systems can cause serious injury or death by electrocution. Consequently, when testing or troubleshooting, carefully adhere to all industry standard safety rules that apply to the situation. Read and follow directions and safety warnings provided by the equipment manufacturer. Don't be misled by low potentials of 12 and 24 volts DC. They may not electrocute you but they can set your boat afire or cause an explosion—with you and others on board!

Here are some troubleshooting safety tips you should know:

- Be sure that all electrical power has been turned off, locked out, and tagged in any situation where you will be in direct physical contact with live circuit components. This is es-

VAUGHN D. MARTIN

pecially important when 117-volt AC dockside power is available. Also, be certain that the power can not be turned on by anyone but you!

- Use only well maintained test equipment. Inspect all test leads (especially the probes) for breaks and cracks and check all on-board fuses before use. Repair or replace any test lead or probe with damaged insulation. Replace defective fuses with new units of the same rating as specified for the equipment by the manufacturer.

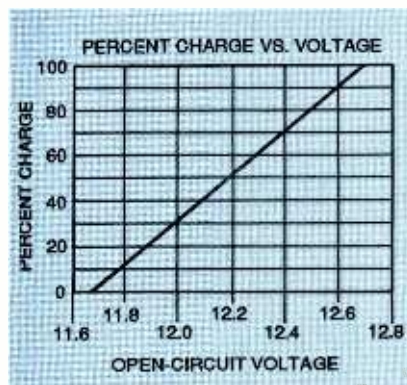

FIG. 1—PERCENT CHARGE vs. lead-acid battery voltage for a common 6-cell battery under no load for 24 hours. Voltage readings will be slightly less for batteries recently used.

- Be very cautious when working on electrical systems when fuel vapors are present. Remember that vapor from gasoline and propane are heavier than air and will collect in the bilge and closed compartments. Sparks generated by making connections with live electrical

components can start a fire or cause an explosion when fuel vapors are present. Ventilate completely to eliminate all explosive vapors before proceeding and cease work immediately should you suspect the dangerous vapors are reoccurring.

- Be aware that charging an unsealed lead-acid batteries generates hydrogen gas. This hydrogen can explode if exposed to a spark generated at the battery terminals when connecting or disconnecting a battery charger. Always verify that the power to the battery charger is off before connecting or disconnecting the charger leads at the battery terminals. Also, carefully observe polarity of the battery chargers cables.

## Batteries

Very often the first sign of a battery problem occurs when the starter won't turn the engine over. Use your multimeter to get an idea of the battery's charge. To perform a no-load test, set the digital multimeter function switch to measure volts DC and connect the leads across the battery's terminals. Compare your voltage reading to the graph in Fig. 1 to determine percent charge.

The above voltage test indicates only the state of charge, not the battery's condition. For example, a battery may register 100 percent charge but would be unable to crank the engines starter for more than five or six revolutions. To gain additional information about the battery's condition, test the specific gravity of the electrolyte in each cell using a hydrometer calibrated

for that purpose. (This test is not possible for sealed batteries.) If the specific gravity is low but relatively the same across all cells, recharging may be able to bring the battery back to good health, unless the plates are sulfated. If they are sulfated, charging the battery will do little to improve its performance—the hydrometer reading would remain low. If one cell shows a specific gravity much lower than the rest, that cell is probably defective and recharging will not help. When you cannot correct the problem by recharging, replace the battery immediately!

Your marina service shop probably has a device that places a load across the battery and provides a voltage reading at the same time. If your battery is sealed and you cannot take a hydrometer reading, see if you can borrow this tool to check out your battery. The meter is usually calibrated Good, Fair, and Bad or Replace.

Sulfated plates can be detected by measuring the output voltage under load after the battery has been fully charged. The sulfate degeneration on the plates of a battery increases its internal resistance. Thus, under load the battery exhibits an internal voltage drop reducing the overall battery voltage to the load (starter), and seriously limiting the amount of current available to start a cold engine. Typical results for a good battery tested under load are given in Fig. 2. Note that the test probe tips must dig into the battery's soft lead terminal post and not the cable clamp-connector.

### Alternators

A digital multimeter's accuracy and display make diagnosing regulator/alternator troubles easy. First determine if the system has an integral (internal) regulator, then whether it's type A or B. Type A is sometimes referred to as P-Type and type B is sometimes referred to as N-type. A type-A regulator has one brush connected to the battery's + terminal and the other brush grounded through the regulator. The Type-B regulator has one brush directly

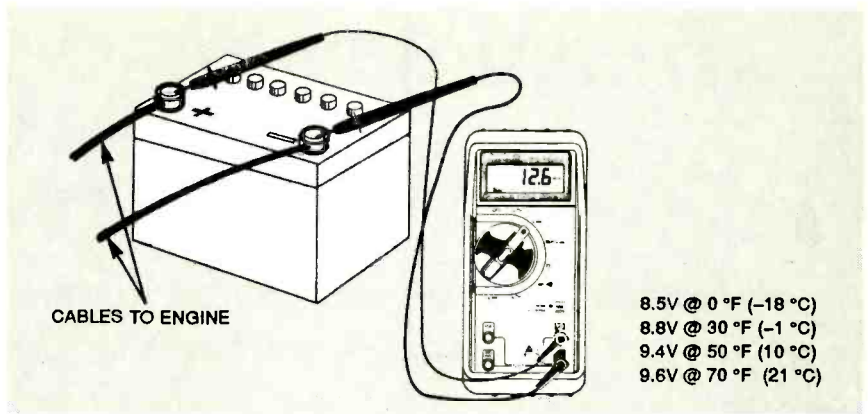

FIG. 2—MEASURING THE BATTERY'S output voltage under load. The chart indicates typical voltage outputs for starter loads at various temperatures.

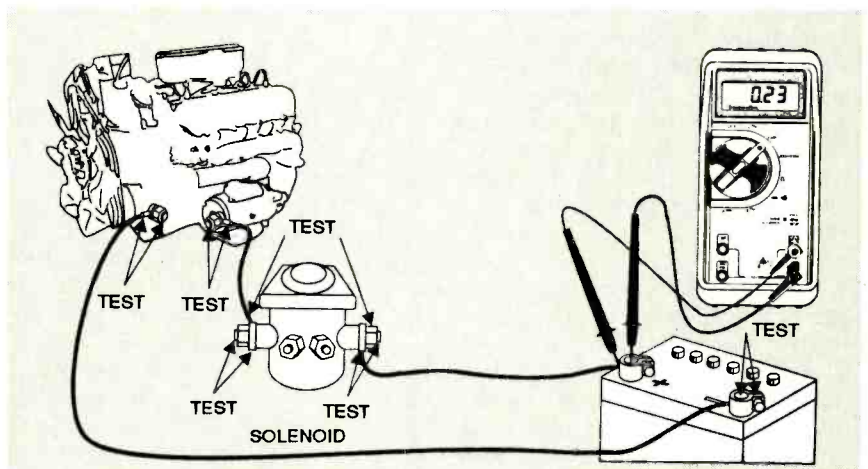

FIG. 3— TO DISCOVER WHERE POWER is being lost when cranking the starter, each connection point in the circuit must be checked for excessive voltage drop. Check across the solenoid assembly; if the resistance is high, replace the unit.

grounded and the other connected to the regulator. (Alternator brushes ride on slip rings in order to connect the field coil mounted on the alternator's armature to a power source.)

Next, isolate the cause of the problem to the alternator or regulator by by-passing the regulator (full-fielding).

Ground the Type-A regulator's field terminal. Connect the Type-B regulator's field terminal to the battery's + terminal. If the system charges now, the regulator is faulty. Use a rheostat in series with the field connection if possible. Otherwise, just idle the engine (lights on) so the voltage doesn't exceed 15 volts.

### Starting systems

Starting system troubles are often confused with charging-system problems. Many dead batteries have been replaced

when the real cause was a faulty charging system. Be sure that the charging system is functioning properly before you replace the battery. Make sure the battery is charged and passes a load test, then look for resistance in the starter circuit should the engine still crank slowly.

In a lead-acid battery, each cell produces about 2.1 volts at full charge. Therefore, a 12-volt battery has 6 cells in series and delivers about 12.6 volts when fully charged. If the no-load test on a fully charged battery reads about 10 volts, a dead cell is likely and the battery should be replaced immediately.

Resistance increases in a starting system when high-current cables are frayed, connections are loose, and terminals are corroded or dirty. Investi-

*Continued on page 79*



# DUAL SCOPE ADAPTER

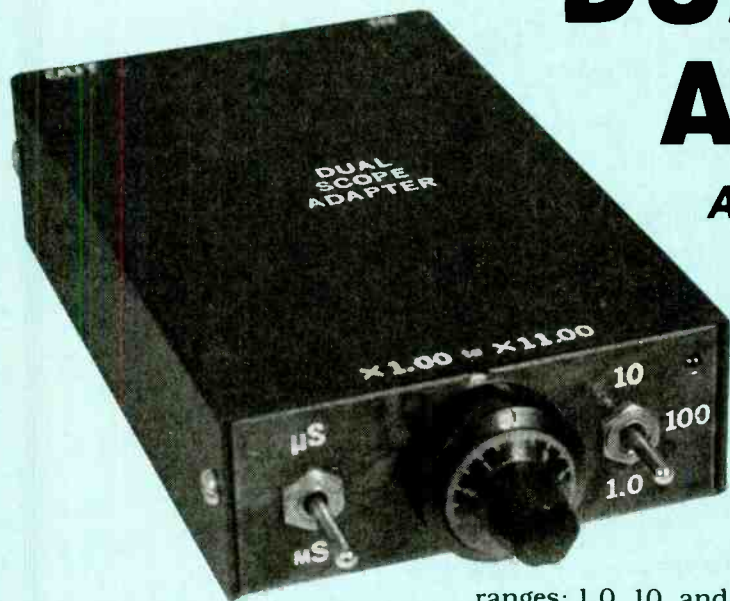

**Add time period cursors and delayed sweep to your oscilloscope with this handy, precision adapter**

SKIP CAMPISI

WOULD YOU LIKE TO HAVE AN OSCILLOSCOPE accessory that makes precise pulse-width or time-period measurements so you do not have to count graticule graduations? Frustrating and time-consuming, manual counting frequently leads to measurement errors. Also, could you use an oscilloscope accessory that permits you to look closer at the leading edges of fast, low-duty cycle pulses at high sweep speeds so you can eliminate all the annoying oscillations in the circuit under test?

The Dual Oscilloscope Adapter offers both of these features. It will permit you to make both pulse-width or time-period measurements and observe leading edges of pulses. It gives you precise time measurements and a rock-solid delayed-sweep mode that requires only that the output cable be switched from one jack to the other. The Voltage Cursor Adapter (*Electronics Now*, May 1995) is the companion to the Dual Oscilloscope Adapter. Together, both accessories will endow your oscilloscope with features available only in far more costly laboratory models.

The Dual Oscilloscope Adapter is essentially a precise ( $\pm 1\%$ ) monostable multivibrator with six, switch-selectable output

ranges: 1.0, 10, and 100 microseconds or 1.0, 10, and 100 milliseconds. Each range can be varied with a precision ten-turn potentiometer equipped with a precise turns counter. With this  $\times 1.00$  to  $\times 11.00$  turns-counter scale, the total range will be 1.0 microsecond to 1.10 seconds.

The adapter output pulse is applied to your oscilloscope's Z axis input (EXT—blanking/intensity modulation input) to provide the time period cursor. It intensifies that part of the oscilloscope trace to be measured (to the exact pulse width set on the adapter), while dimming the rest of the trace.

This method makes reading the measurement both easy and precise. By adjusting the adapter's slope controls, either any section or the entire waveform period can be measured. The sweep is delayed by applying the output of the adapter to the TRIGGER input of your oscilloscope in the external trigger mode.

The adapter was designed to operate from an external  $\pm 5$ -volt supply to minimize the pickup of hum and noise from the AC line. A schematic diagram and parts list for a suitable wall-outlet-mounted dual power supply is included in this article for those who do not have a suitable one or cannot find a convenient source for purchasing one.

## How does it work?

Figure 1 is the schematic for the dual oscilloscope adapter. The input stage is the trigger amplifier based on the two channels of an LM319 dual comparator (IC1-a and IC1-b). The input signal is taken from the CHANNEL 1 output jack of your oscilloscope, and it is applied to J1 on the adapter.

The author's prototype was designed to work with a Hitachi V-212 oscilloscope, which has an output of 25 millivolts per division on its vertical signal display into a 50-ohm load. Assuming a normal display of about six divisions, a trigger level of about  $\pm 150$  millivolts is desired. This range is set by the ratio of the values of resistor R4 to R5, and is varied by voltage divider R6, the TRIGGER LEVEL control.

This ratio can be altered to be compatible with your brand of oscilloscope, but be sure to maintain the ratio of R3 to R5, which gives the correct amount of hysteresis for proper triggering. The INPUT SLOPE is selected by switch S1, and the signal is coupled to C3 and IC2, the multivibrator stage.

Capacitor C3 provides the proper negative-going pulse to trigger IC2, a TLC555 CMOS timing IC circuit, and it also limits the minimum required input pulse width to about 500 nanoseconds. Switch S2 selects the desired range—either milliseconds or microseconds, and

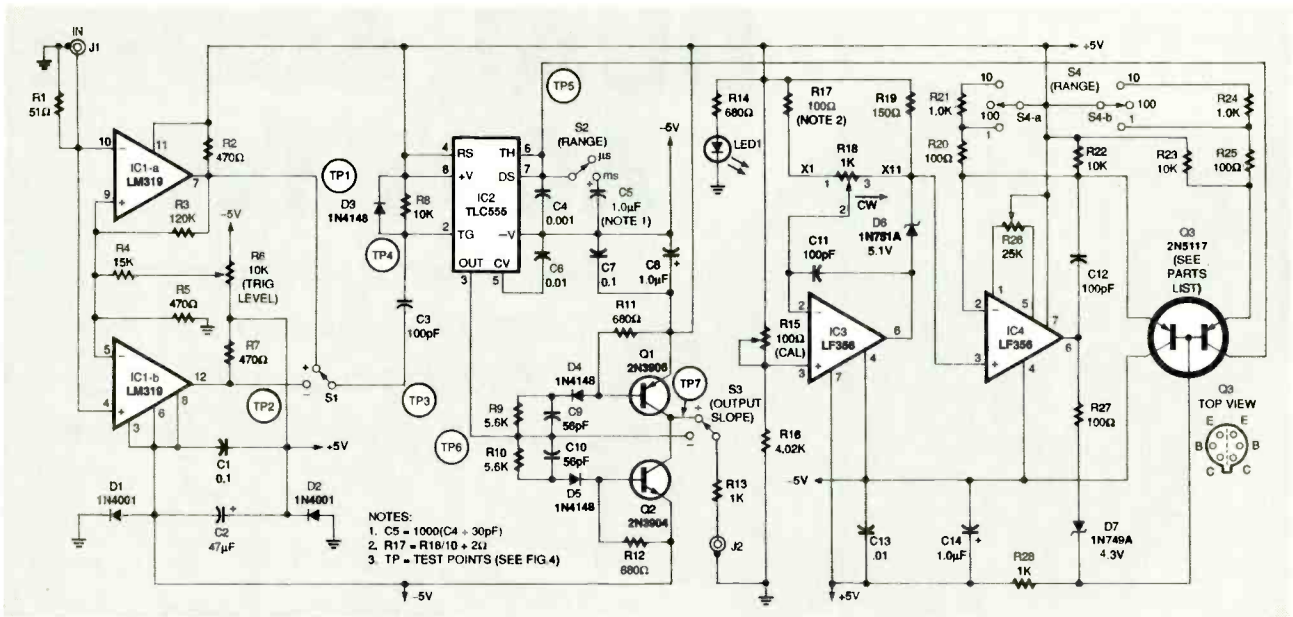

FIG.1—SCHEMATIC FOR THE DUAL OSCILLOSCOPE ADAPTER. The components are assembled on a multipurpose PC board.

switch S3 selects the polarity of the output slope. About 30 pF of stray capacitance exists at the junctions of C4, Q3, and IC2. Thus, to obtain the highest accuracy, select or trim capacitor C5 or C4 so that  $C5 = 1000 \times (C4 + 30 \text{ pF})$ .

Transistors Q1 and Q2 form a fast (less than 10-nanosecond delay) inverting output stage. The output from switch S3 is  $\pm 5$  volts, which is sufficient for excellent contrast in intensity modulation. It is also satisfactory for stable triggering in the adapter's delayed-sweep mode. Resistor R13 (1 kilohm) isolates the output stages from the ca-

pacitance of the connecting cable. This value provided the necessary isolation on a 3-foot length of RG-174 and 6-foot length of RG-58 coaxial cable. However, you might have to select a different value for your brand of oscilloscope.

Precise input current to capacitors C4 and C5 is supplied from the collector of dual transistor Q3, a 2N5117. It is a dual matched PNP pair in one package. Each transistor is electrically isolated but thermally coupled. Operational amplifier IC3, an LF356, is configured as a noninverting follower with gain. It supplies the correct re-

reciprocal voltage reference function to IC4, the second LF356. It is a buffer with half of Q3 in its feedback loop.

Transistor Q3 is configured as an unusual "current mirror" that unloads the relatively slow operational amplifier, allowing the second half of Q3 to demonstrate its fast dynamic response. A reference voltage is developed across both sets of emitter resistors (R20 to R25) to produce the constant charging current for capacitors C4 and C5. The two sections of switch S4 (S4-a and S4-b) select the range—either 1.0, 10, or 100, in conjunction with switch S2 (milliseconds or microseconds).

Zener diodes D6 and D7 permit the operational amplifier outputs to operate in their linear regions. Variable resistor R18 (1 kilohm, 10-turn) is the range multiplier. It has a 15-turn counting dial mounted on its shaft. See the directions in the construction section for mounting this dial to the shaft of the precision potentiometer.

### Building the adapter

All of the circuitry for the author's prototype fit in a standard, off-the-shelf, two-part aluminum case that measures approximately  $1\frac{1}{4} \times 3 \times 5$  inches. These cases are available from many different suppliers. The circuit board is a

*Continued on page 85*

TABLE 1—SPECIFICATIONS FOR THE DUAL OSCILLOSCOPE ADAPTER

Power Supply:  $\pm 5$  Volts (regulated), 100 mA

Parameter	Value	Units	Condition
Input voltage (max)	$\pm 5$	V	
Input voltage (min)	$\pm 25$	mV	
Trigger voltage range	$0.0 \pm 150$	mV	
Input rise/fall (max)	00		
Input frequency (max)	500	KHz,	(min)
Input pulse width (min)	500	ns	(typ)
Propagation delay (J1 to J2)	250-300	ns	(typ)
Input Impedance	51	ohms,	(typ)
Output pulse range	1.0-1.10	ms-s	
Output pulse voltage	$\pm 5$	V	
Output impedance	1000	ohms	(typ)
Output Pulse Accuracy	+1	%	$10\mu\text{s}-1.10\text{s}$
Output Rise/Fall Time	20	ns	(typ)
Reference Voltage (x1.00 to x11.00)	670-61	mV	(typ)

# Modern power-factor correction and Internet addressing

**T**HE INTENT AND MEANING OF THE TERM *POWER FACTOR CORRECTION* SURE HAS CHANGED A LOT LATELY. THIS APPEARS TO BE CAUSING A LOT OF CONFUSION ON MY HELP-LINE. TO STRAIGHTEN SOME OF THIS out, lets get back to the basics...

## Power factor: then and now

An electronic *component* is *passive* when there's zero net energy input from anywhere other than its input leads. A component is *linear* if it does not change in any manner with time. Also, in any linear component, the stimulus must be proportional to the response. Kick it twice as hard and it should "ouch" twice as loud.

There are only three possible *ideal* passive linear electronic components. All real components are made up of lumped or distributed combinations of these three.

The first component is the *resistor*. A resistor converts current into heat or light energy, following a *power = volts (amps)* equation. Since there is zero energy storage, there is no way your current can get behind or ahead of the voltage. Current and voltage are said to be *in phase*.

When a fixed-frequency sine-wave voltage is applied, a sine-wave current will result. This current follows the voltage per Ohm's law.

The second component is known as the *inductor*. An inductor is a coiled conductor with or without a field-intensifying core. An inductor *temporarily* will convert

current into energy storage in a *magnetic field*.

The voltage-current rule for any inductor states that...

$$e = L\Delta i/\Delta t$$

This tells us that the voltage across an inductor is proportional to its size times the *rate of change* of a current through it. As the current increases, the magnetic field energy will go up and vice versa.

A pure inductor does *not* "waste" energy. It simply *stores* energy in its internal magnetic field. When a voltage gets applied to an inductor, its current will slowly build up. Thus, current will be "behind" the voltage in an inductor. If you apply a voltage sine-wave, you should see a current *cosine* wave which is precisely one quarter cycle behind. Since there are 360 degrees of phase in one full cycle, we say that the inductor current *lags* in phase by exactly 90 degrees.

The third ideal component is called the *capacitor*. A capacitor is a pair of conducting plates separated by air or other insulating material. A capacitor *temporarily* converts voltage into energy storage in some *electric field*.

The current-voltage rule for a

capacitor states that...

$$i = C\Delta V/\Delta t$$

...telling us that the current into a capacitor is proportional to its size times the *rate of change* of voltage across it. As the voltage goes up, the electric field energy goes up and vice versa. Reversing the voltage also reverses the sense of the field energy.

As with the inductor, an ideal capacitor does *not* waste any energy. It stores that energy in its electric field. If a current is sent to a capacitor, its voltage will slowly build up. The current will usually be ahead of the voltage in a capacitor. Which has to mean that the voltage will usually be behind the current. If you apply a voltage sine-wave, you'll get a current *negative cosine* that is precisely one quarter cycle *ahead*. Since there are 360 degrees of phase in one full cycle, we can say that the current *leads* by 90 degrees.

There's an easy and ancient way to remember all this: Good old *ELI the ICE* man. The *E* (voltage) is ahead of the *I* (current) in the *L* (inductor). The *I* is ahead of the *E* in the *C* (capacitor).

Ideal components do not occur in the real world. Because an insulator, conductor, or semiconductor above absolute zero *will* have resistance and unavoidable conversion of current into heat. Any conductor that routes between two separate points in space *will* have inductance and unavoidable magnetic field energy storage. And any two con-

new from  
**DON LANCASTER**

**ACTIVE FILTER COOKBOOK**

The sixteenth (!) printing of Don's bible on analog op-amp lowpass, bandpass, and highpass active filters. De-mystified instant designs. **\$28.50**

**CMOS AND TTL COOKBOOKS**

Millions of copies in print worldwide. THE two books for digital integrated circuit fundamentals. About as hands-on as you can get. **\$24.50** each.

**INCREDIBLE SECRET MONEY MACHINE II**

Updated 2nd edition of Don's classic on setting up your own technical or craft venture. **\$18.50**

**LANCASTER CLASSICS LIBRARY**

Don's best early stuff at a bargain price. Includes the CMOS Cookbook, The TTL Cookbook, Active Filter Cookbook, PostScript video, Case Against Patents, Incredible Secret Money Machine II, and Hardware Hacker II reprints. **\$119.50**

**LOTS OF OTHER GOODIES**

Ask the Guru I or II or III	\$24.50
Hardware Hacker II or III	\$24.50
Micro Cookbook I	\$19.50
PostScript Beginner Stuff	\$29.50
PostScript Show and Tell	\$29.50
Intro to PostScript Video	\$29.50
PostScript Reference II	\$31.50
PostScript Tutorial/Cookbook	\$19.50
PostScript by Example	\$31.50
Understanding PS Programming	\$29.50
PostScript: A Visual Approach	\$22.50
PostScript Program Design	\$24.50
Thinking in PostScript	\$22.50
LaserWriter Reference	\$19.50
Type 1 Font Format	\$15.50
Acrobat Reference	\$24.50
Whole works (all PostScript)	\$380.00
Synergetics Surplus Catalog	FREE
Technical Insider Secrets	FREE

**POSTSCRIPT SECRETS**

A Book/Disk combination crammed full of free fonts, insider resources, utilities, publications, workarounds, fontgrabbing, more. For most any PostScript printer. Mac or PC format. **\$29.50**

**BOOK-ON-DEMAND PUB KIT**

Ongoing details on Book-on-demand publishing, a new method of producing books only when and as ordered. Reprints, sources, samples. **\$39.50**

**THE CASE AGAINST PATENTS**

For most individuals, patents are virtually certain to result in a net loss of sanity, energy, time, and money. This reprint set reveals to you tested and proven real-world alternatives. **\$28.50**

**BLATANT OPPORTUNIST I**

The reprints from all Don's Midnight Engineering columns. Includes a broad range of real world, proven coverage on small scale technical startup ventures. Stuff you can use right now. **\$24.50**

**RESOURCE BIN I**

A complete collection of all Don's Nuts & Volts columns to date, including a new index and his master names and numbers list. **\$24.50**

**FREE SAMPLES**

Well, nearly free anyway. Almost. Do join us on GENIE PSRT to sample all of the Guru's goodies. The downloading cost on a typical Guru file is 21 cents. Modem access: (800) 638-8369, then a JOINGENIE. Use DMD524 for your keycode

FREE VOICE HELPLINE VISA/MC

**SYNERGETICS**  
Box 809-EN  
Thatcher, AZ 85552  
(520) 428-4073

**ELI THE ICE MAN**

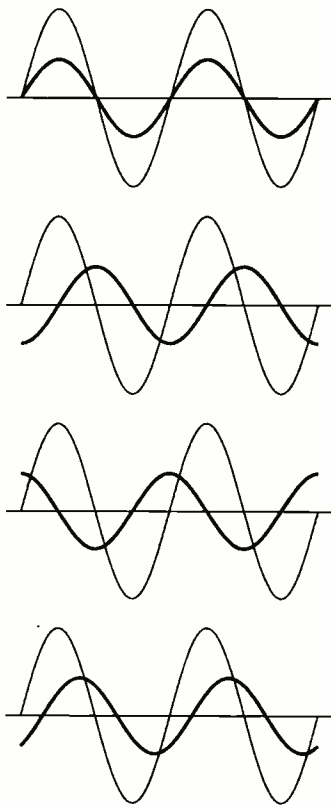

In an ideal **RESISTOR**, all incoming energy is converted to heat without any field storage. Voltage and current are in phase. The power factor is 1.0.

In an ideal **INDUCTOR**, all incoming energy is converted to energy storage in a magnetic field. Current **lags** voltage by 90 degrees. The power factor is 0.

In an ideal **CAPACITOR**, all incoming energy is converted to energy storage in an electric field. Current **leads** voltage by 90 degrees. The power factor is 0.

A real **MOTOR** has both inductive and resistive components. Current lags voltage by the ratio of real to reactive power. The power factor shown here is 0.8 lagging.

**FIG. 1—THE POWER FACTOR** of a circuit is the ratio of the real to reactive input power. Power factor is expressed as the cosine of the phase angle between the voltage and current. A classic power factor correction involves getting the input fundamental frequency voltage and current in phase.

ductors separated by an insulator *will* have capacitance and unavoidable electric field storage. I have summarized these lead-lag rules in Fig. 1.

**Enter the power company— stage left**

The power company only charges you for the energy you actually *use*. Generating light, burning it as heat, converting it to a mechanical motion (which ultimately becomes heat), or by otherwise never returning it. On the other hand, the energy you store in an inductor gets returned early on in the next cycle. As does any energy you might store in any capacitor.

We can define *real* power as the energy you actually use. The *reactive* power is energy that swaps back and forth between you and your utility company, temporarily getting stored in electric or magnetic fields.

The *power factor* is defined as the ratio of the real energy to reactive energy. Specifically, it is the *cosine* of the *phase angle* of the current waveform compared with the voltage.

A purely resistive load would have a power factor of 1.0 or unity. Any load which stores as much magnetic energy in an inductor as gets actually used would lag by 45 degrees or have a power factor of 0.707 *lagging*. A load which retains as much electric energy in a capacitor as gets actually used would lead by 45 degrees or have a power factor of 0.707 *leading*.

The power factor of any ideal inductor or capacitor is zero. Why? Because the cosine of +90 or (90 degrees is precisely zero. Why should the power utility care how much reactive power you use? After all, you're going to give it right back a few milliseconds later. The problem is that

line *current* is required *both* for real and reactive power. The *extra* current consumed by all your reactive loads still causes utility losses in the resistance of their lines. It also demands higher currents in all the generators and transformers and such. The utility's costs go up, yet they have sold no more electricity.

Most of your home loads are resistive (light bulbs, for example) or partially inductive (motors and compressors). Capacitive loads (such as an electroluminescent night light) are quite rare in normal home or industrial use. Thus, you are likely to have a lagging power factor.

The power company applies *power factor compensation* to clean up their own act. They might compensate their reactive power by hanging capacitors on poles every now and then, or by purposely overdriving a synchronous generator to intentionally produce a *leading* power factor.

But note that hanging capacitors on one line end to compensate for inductors on the other does not fix much, because the reactive current *between* the two still contributes to huge transformer and line losses. Thus, *a utility cannot "fix" a customer's power factor.* Utilities do punish large industrial electricity users if their power factor is too low. Their bill goes up when their power factor goes down. This encourages the industrial user to do its own power factor correction with capacitors or overdriven generators.

So, the classic definition of *power factor correction* was taking steps to reduce longer distance fundamental frequency reactive energy transfers. Getting the fundamental frequency voltage and current waveforms back in phase with each other.

### The modern problem

All of that is ancient electrical engineering. But lately, things went non-linear. Electronic circuits started needing lots of rectifiers for internal DC power. The loads were no longer time-invariant. Figure 2 shows the current waveform of a typical capacitor-input full-wave rectifier. For most of each half cycle, *zero* power is drawn. It is only very near the *peak* of each

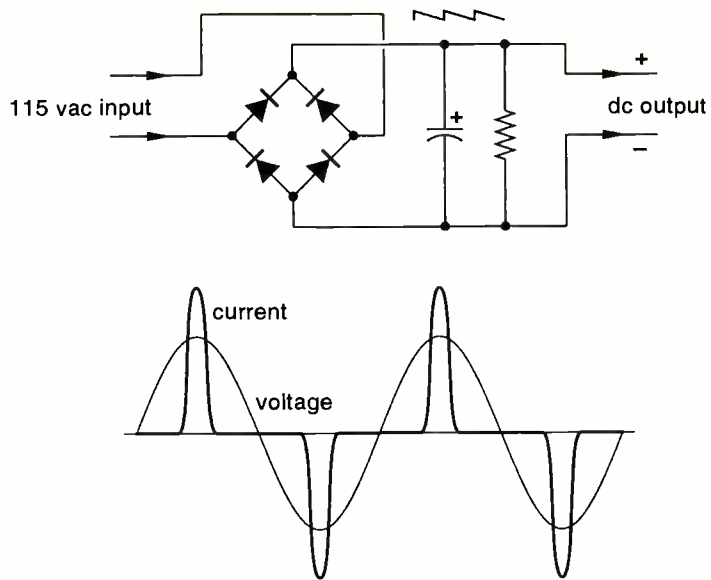

**FIG 2**—A TYPICAL LINE-OPERATED POWER SUPPLY draws its current in very large, very narrow, and high harmonic mid-cycle pulses. Modern power-factor correction involves both minimizing these harmonics and getting the input fundamental frequency voltage and current in phase.

half cycle that the diodes switch on and draw a humongous and very narrow slug of current.

The utility has to provide this peak current. In spite of the fact that they are doing *absolutely nothing useful* for the rest of the cycle.

Well, the *fundamental frequency* voltage and current are still in phase with each other. At first glance, there appears to be no need for any classic power-factor correction.

But my oh my, the harmonics. As we have seen before, narrow pulses consist of a fundamental frequency and lots of harmonics. Mostly odd, some even. *Fourier* series and all. Besides having to provide ten or twenty times the peak fundamental current capability, there's bunches of harmonics overloading the utility's transformers and such.

Ordinary home electronics is bad enough. But we've now got lighting ballasts and industrial motor controls adding to the mess. Something has to be done to minimize these harmonics and outrageous current slugs.

The trick is to do what you have to so that your drawn current gets back to looking at least roughly like an in-phase fundamental frequency sine-

wave. And that is what modern power factor correction is really all about—harmonic stomping.

So, the definition for "new" power factor correction is making all of the current drawn to be in phase with the fundamental voltage *while* having as little harmonic energy as possible.

One way to handle this waveform improvement is with a *preregulator*. You still use a full wave rectifier, but you only *lightly* filter it with a small capacitor. The diodes now conduct over nearly the full cycle. You next take this changing full wave rectified waveshape and then *step it up* to a fixed and higher DC voltage. Say 200 volts. You can do this with a special regulator that involves a *power factor correction* integrated circuit.

Now for the tricky part: Not only do you have to step your voltage up differently in different parts of *each* half cycle, but you also want to draw *less* current with *large* stepups. And *more* current with *small* stepups!

The reason for all this is that you will want the *average* of your drawn current to look pretty much like a fundamental and in-phase sine wave. Thus, early in your half cycle, you'll want low currents but high voltage

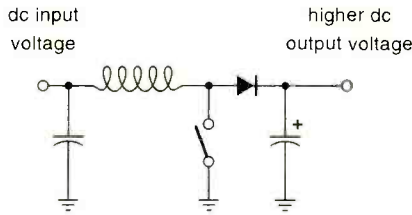

**FIG. 3—A BOOST SWITCHING REGULATOR CIRCUIT** is normally used for stepping up DC voltages. Repeatedly closing the switch ramps up the current. Opening it transfers the stepped-up voltage to the load. The same idea can be used for power-factor correction if you input a full-wave rectified waveform and if you use very fancy switch duty cycles and repetition rates. The tricky part involves drawing more average current mid-cycle and less near the edges.

stepups. A quarter way into the half cycle, you should want to be drawing more current but providing for less voltage stepup. And midway at the half cycle peak, you'll want lots of current but only a minimal stepup.

Figure 3 shows a switching circuit known as a *boost regulator*. You briefly close your switch. The current in the inductor starts at zero and begins ramping up. Open the switch. Because of good old  $(\Delta i/\Delta t)$ , you can not immediately change the current through an inductor.

*The current through the inductor will be the same immediately before and immediately after you open the switch.*

The diode now conducts and the inductor delivers its current into the output capacitor and load.

The inductor's current should now start dropping, caused by the draw of any resistive load. Close the switch again to ramp up your current. Open the switch to transfer energy to the load. The inductor's current will be roughly constant but has a slight high frequency triangular ripple.

Your typical switching frequencies these days go from 20 kHz on upwards. As you vary the *duty cycle*, or the percentage of time the switch is on, you'll vary the output voltage. Feedback can hold the output voltage to any voltage you like.

Well, any voltage *above* the input supply that is. If you never close the switch, your input voltage appears at the output. Thus, a boost converter is just that—a method for controllably

*increasing* an input voltage. To convert a boost regulator into a power factor corrector, we have to get sneaky with our switch timing. At mid waveform, we will want a *short* on-time for a limited step up. However, we will also want a *high frequency* for maximum current.

Near the waveform zeros, we will want a *long* on time for a *large* step up. But we'll also need a much *lower frequency* to do the stepups not as often for lower current. Thus, some really fancy footwork is required to continuously change *both* the step up ratio and the drawn current. All the while adjusting for a changing load current or a drifting supply voltage. But all you are doing is continuously changing the repetition rate and the pulse width in a magic way.

Note that the small input filter capacitor provides an averaging energy storage for these high frequency variations. All that the utility has to give us is a clean fundamental frequency current sinewave at unity power factor. Three primary sources for power factor correction chips include *Micro Linear*, *SGS* and *Unitrode*. Free applications notes are available. The trade magazines here include *Power Quality* and the *EPRI Journal*.

## INTERNET RESOURCES

### Boardwatch

8500 W Bowles Ave #210  
Littleton CO 80123  
(303) 973-6038

### InformationWeek

PO Box 1093  
Skokie IL 60076  
(516) 562-5000

### Inter@ctive Week

100 Q Roosevelt Blvd # 508  
Garden City, NY 11530  
(516) 229-3700

### Internet Market Report

5841 Edison Place  
Carlsbad CA 92008  
(619) 438-8100

### Internet World

20 Ketchum Street  
Westport CT 06880  
(203) 341-2872

### The Net

1350 Old Bayshore #210  
Burlingame CA 94010  
(415) 696-1688

### NetGuide

600 Community Drive  
Manhasset Ny 11030  
(516) 562-5000

### Network Solutions

505 Hunter Park Drive  
Herndon VA 22020  
(703) 742-4777

### WEB Techniques

600 Harrison Street  
San Francisco CA 94107  
(303) 661-1885

### WEBsmith

Po Box 55549  
Seattle WA 98155  
(206) 782-7733

### WEB Week

20 Ketchum Street  
Westport CT 06880  
(708) 564-1385

### Wired

544 2nd St 3rd Fl  
San Francisco CA 94107  
(415) 904-0664

## Your own web page

How do you get your own private Internet address for email? How can you start your own web page? The Internet location addresses are specified by a *domain*. To get on the net, you'll need access to a domain. Internet domain addresses are groups of characters separated by periods. An "@" separates internal from external locations. Thus a *browseretta@woof.com.us* may be a complete Internet address. The *.us* is the country. This can be eliminated for US addresses. But a *.uk* stands for England, and so on. The second domain level is usually a *.com* (if a for-profit company), *.org* (if a non-profit organization), *.gov* (if government), *.edu* (university), or a *.net* (for another network).

Here, *woof* is the *service provider*. That is someplace where a computer runs continuously to send and receive net contents for you. You hire a local service provider at \$18.50 per month from the ads out of your local paper, or get limited free access from your long distance phone service, or subscribe to a commercial online service. Such as *Compuserve*, *GENie*, *Prodigy*, or *AOL* at about \$3 per hour.

Or, you can become your very own service provider. And dedicating your own computers and modems to full

## NAMES AND NUMBERS

high speed access duty (hundreds of dollars per month plus big bucks in equipment and skills). And *bowseretta* is the woofier who is actually subscribing to the Internet access. Should Bowseretta go and start up her own kennel, her internal accounts would get separated by *rover@bowseretta@woof.com*

Should some version of automated processor be used, it might have an address of...

*server@bowseretta@woof.com*

My own two Internet addresses are currently *synergetics@genie.com* and my new *tinaja.com* web site.

You have two choices for internet addresses: *Unregistered* names can be anything that you and your access service can agree on. They are also usually free. But there is nothing to stop someone else on the net using the same name. *Registered* names are exclusively available for your use. Your service provider will offer a *pass thru* name for an additional fee. For instance, if Bowseretta registers, she can become *Bowseretta.com*. Pass-thru's give you a shorter address.

To find out if a registered name may be available, you get on the Net and go to *www.internic.net*. Select their *whois query form*. To actually register a name, click on the *new domain registration* link. A form and detailed instructions will be emailed back to you. Fill in and crop your form. Return your form to *hostmaster@internic.net* Use the words *New Domain* as the *Subject*.

The cost is \$100 for the first two years. Then \$50 per year afterward. Typical registration takes several weeks. The billing is by mail or online. Domain registration is by email only. Details are shown in Fig. 4. Internic is also *Network Solutions*. I have shown the address in this month's *Internet Resources* sidebar, along with a few of the Internet hard copy magazines.

### Magnetic levitation

Everyone from physics students to perpetual motion machine fans have been fascinated by that ability of like-pole magnets to repel each other. Slide two or more ring magnets onto a wooden dowel and all of the upper magnets will mysteriously "float" in

#### American Science & Surplus

3605 Howard St  
Skokie IL 60076  
(708) 982-0870

#### Beyond Electronics

213 Harding Way East  
Galion OH 44833  
(800) 747-2861

#### Bunting Magnetics

500 S Spencer Avenue  
Newton KS 67114  
(316) 284-2020

#### Commonwealth Trading Co

1685 E Park Place Blvd  
Stone Mountain GA 30087  
(770) 469-7292

#### Edmund Scientific

101 E Gloucester Pike  
Barrington NJ 08007  
(609) 573-6250

#### EPRI Journal

PO Box 10412  
Palo Alto CA 94303  
(415) 855-2000

#### Eriez Magnetics

PO Box 10608  
Erie PA 16514  
(814) 833-9881

#### Fujitsu

3545 N First St  
San Jose CA 95134  
(800) 642-7616

#### Littelfuse

800 E Northwest Hwy  
Des Plaines IL 60016  
(708) 824-0400

#### Magnet Source

607 S Gilbert  
Castle Rock CO 80104  
(800) 525-3536

#### Micro Linear

2092 Concourse Dr  
San Jose CA 95131  
(408) 433-5200

#### Oak Ridge Natl Labs

PO Box 2008 MS-6087  
Oak Ridge TN 37831  
(423) 574-4281

#### Physics Teacher

5112 Berwyn Road  
College Park MD 20740  
(301) 345-4200

#### Power Quality

2742 Eastman Ave #33-34  
Ventura CA 93003  
(805) 650-7070

#### Probe Master

215 Denny Way  
El Cajon CA 92020  
(800) 772-1519

#### SGS-Thomson

1000 E Bell Rd  
Phoenix AZ 85022  
(602) 867-6259

#### Small Parts

PO Box 4650  
Miami Lakes FL 33014  
(305) 557-8222

#### Synergetics

Box 809  
Thatcher AZ 85552  
(520) 428-4073

#### Talking Electronics

626 S Euclid Street  
Anaheim CA 92802  
(714) 533-4252

#### Test Probes Inc

9178 Brown Deer Road  
San Diego CA 92121  
(619) 552-2090

#### Thomson Industries

2 Channel Drive  
Port Washington NY 11050  
(800) 554-8466

#### UFO

Box 119A  
Kingston NM 88042  
(505) 895-5608

#### Unitrode

580 Pleasant St  
Watertown MA 02172  
(617) 926-0404

#### Walker Scientific

Rockdale St  
Worcester MA 01606  
(800) 962-4638

air, provided that the like poles of each magnet face each other. North to north or south to south. The effect seemingly exhibits "antigravity."

Actually, the vertical forces cancel at a height where your upward magnetic repulsive forces exactly balances the downward gravitational pull. Unfortunately, you can't take the stick

away because there is no lateral stability. And, of course, there is no free lunch here. The energy needed to place two magnets in any position where they can repel each other will *always* exceed any energy that can be recovered.

Similar magnetic repulsion effects are often used in "frictionless" mag-

netic bearings and in maglev trains.

The *Levitron* is a fascinating new combination science toy, magic trick, and *Golly Gee Mister Science* party mind-blower. The *Levitron* uses the angular momentum of a spinning top to stabilize the magnetic repulsion of a pair of ring magnets. The spinning top literally floats in air for two or more minutes at a time. It appears eerily locked yet somehow alive in a fixed position in space an inch or two above a table.

No, there are no batteries. Nor any electricity or other energy source of any kind. Beyond that initial kinetic energy imparted as momentum. And no, it is not an illusion. You can wrap your hand totally around the floating top. You can even "capture" the top inside a glass and then actually put a lid on the glass!

Top operation is more than a little tricky. You'll need lots of patience to master the technique. You first place a plastic sheet above your magnetic base and *carefully* locate the center magnetic null point. Then, with your elbow held *very* high, you give the top a sharp spin. Next, you *slowly* raise the leveled plastic sheet until the top *just barely* launches itself upwards. Remove the sheet, and the top does its anti-gravity bit, at least until the air resistance slows the top below a stability limit.

The exact mass of the top is *very* critical, so there are some weighted washers and O-rings you can add or remove. If the top leaps up, it is too light. If it never floats at all, then it is a tad too heavy.

The magnetic base also has to be on a solid surface and *exactly* level. A pair of wedges are provided. If the floating top leaves to the east, you *raise* the east side of the base. Use one wedge for east-west; the other for north-south. All in all, the effect is well worth the time and effort to master it.

One *Levitron* source is *UFO*. Short for Mike Sherlock's *Unlimited Fun Options*. \$44.95 for the *Levitron* plus a well-done 24 minute video. *Do not attempt to use the Levitron without carefully watching the entire video first!* More *Levitron* theory is in the April 1995 *Physics Teacher*.

#### NON-EXCLUSIVE DOMAIN –

Simply contact your service provider and ask for a name. There is usually no extra charge. Your domain will be in form *yourname@servprov.com* Others can still freely use *yourname*, and your full address *will* have to change when and if you switch service providers.

#### EXCLUSIVE DOMAIN –

First, <http://internic.net> and select their *whois query form* to find out if your intended name is still available. To find out if *yourname.com* is available, enter *whois yourname.com* This will tell you who *yourname.com* is. Or that the name *might* still be available for registration.

Second, email [mailserv@rs.internic.net](mailto:mailserv@rs.internic.net) and request a domain registration form. Fill in the form and crop the instructions with your word processor. Then return it to [hostmaster@internic.net](mailto:hostmaster@internic.net).

There is a \$100 registration fee for the first two years, then \$50 per year afterwards. Your exclusive domain name will be in form *yourname.com* Registration *must* be done online. The process usually takes a few days.

Finally, go to your service provider and request a "pass through" or "direct" access service. An extra monthly premium may be charged.

FIG. 4—TWO ROUTES TOWARD your own Internet domain name.

#### An antigravity contest

Alas, the *Levitron* is not very user friendly. It has only a strictly limited stability range. A bare *minimum* of two to three hours of solid practice is required to master its operation. This, of course, is also true for most real magic tricks. Once mastered, though, you levitate nearly every time. And you'll be the only one at the party that can get the beast to work at all—particularly when you add such misdirecting hogwash as "Well, you have to wear an orange shirt."

The *Levitron* is not at all suitable for smaller children because of its small, edible parts and the frustration involved in mastering it. For this month's contest, show me some modifications to the *Levitron* which will make it friendlier. A second base *above* the top might help, but this would hurt the illusion. Or we could include some sort of an active electronic feedback network.

Could you gimbal the magnets to automatically level? How can you do this at very low cost? How can that magnetic "stability well" be increased? It's been pretty much proven that two ring magnets producing inverse square repulsive fields can not be forced inherently stable—at least not without serious outside help. But can

some tricks be pulled to improve the size, shape, and depth of the stability well? Possibly a lot of tiny magnets in a ring but tilted slightly inward?

Why is it necessary to recalibrate the top's mass? Does the temperature *really* make that much difference? Why? Can calibration be done with a real time base adjustment? Another possibility: If you capture the top inside a covered glass, could there be some way to *reduce* the air pressure in the glass? Even a vacuum of only one-fifth atmospheric might let the top float for a half an hour or more. Could something like a spray bottle pump help here?

To experiment on your own, tops and low cost magnets are available from *Edmund Scientific*. Or else from *American Science & Surplus*. O-rings and washers are available from *Small Parts*. Industrial magnet sources are *Bunting*, *Eriez*, and *Magnet Source*. Big time magnetic instrumentation is offered by *Walker Scientific*. As usual, there'll be copies of my *Incredible Secret Money Machine II* book going to the best dozen entries, along with an all expense paid (FOB Thatcher, AZ) *tinaja quest* for two going to the very best of all. Be sure to send all of your *written* entries to me here at my

*continued on page 76*



# Experiments With Laser Light

ONE OF THE MAJOR PURPOSES OF THIS MONTH'S COLUMN IS TO INTRODUCE FIRST-TIME LASER ADVENTURERS, AS WELL AS SEASONED EXPERIMENTERS TO SOME OF THE THOUSANDS OF WAYS THAT LASERS CAN AID, BENEFIT,

and even entertain you. Hands on experiments and demonstrations are great ways to display the wonders, and applications of this unique light form. We hope to give you a far better understanding of the laser and to offer many new ideas for its use. These should give you some ideas of your own and we invite you to share them with us. Send your ideas to *Laser Applications Editor, Electronics Now magazine, 500 Bicutny Boulevard, Farmingdale NY 11735, or via E-mail to lartronics@aol.com.*

## Light beam modulation

The term Modulation is a controlled change of an otherwise constant signal to convey information or data. There are two ways to modulate a laser beam: mechanically and electronically. Let's explore the mechanical methods first, as they produce the most dramatic effects.

If you shine the beam onto a reflective surface that can be moved, the resulting beam traces patterns caused by that movement. One interesting way to do this is to get the surface to move in tandem with speech, music, or other sounds. There are commercially available X-Y modulators and axis generators that do a great job at

converting sound to patterns. They sell for \$100 and up. An easy and far less expensive approach is to use an old 3- or 4-inch, 8-ohm speaker, together with a 1½- to 2-inch length of flexible spring, and a ¾-inch square of thin but rigid aluminumized mylar.

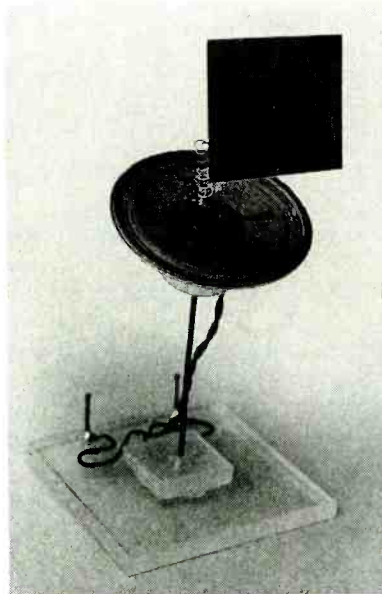

**FIG. 1**—A SPEAKER MODULATOR using flex-wire for positioning, and a small speaker with cone still intact.

You can use the speaker as is. I did, as you can see in Fig. 1. To reduce the sound output, which you

## WARNING!!!

This article deals with and involves subject matter and the use of materials and substances that may be hazardous to health and life. Do not attempt to implement or use the information contained herein unless you are experienced and skilled with respect to such subject matter, materials and substances. Neither the publisher nor the author make any representations as for the completeness or the accuracy of the information contained herein and disclaim any liability for damages or injuries, whether caused by or arising from the lack of completeness, inaccuracies of the information, misinterpretations of the directions, misapplication of the information or otherwise.

might find disturbing, cut the cone out of the speaker, leaving the frame and the center circle covering the voice coil assembly. Use a dab of epoxy or silicon cement to attach one end of the spring to the center circle of the speaker—the less cement the better. When the cement is dry and the spring is in place, attach a corner or edge of the square of mylar to the loose end of the spring. Then mount the speaker on a stand with a swivel joint so the angle can be set anywhere within a 360-degree pattern, and you have a simple, but effective X-Y axis generator. A close-up photograph of the completed device is in Fig. 1.

To use your axis generator, connect the modified speaker to the output of a stereo, TV, radio, or other sound source. Then direct the angle of the speaker so that a laser beam aimed at the mylar creates a reflection that bounces back

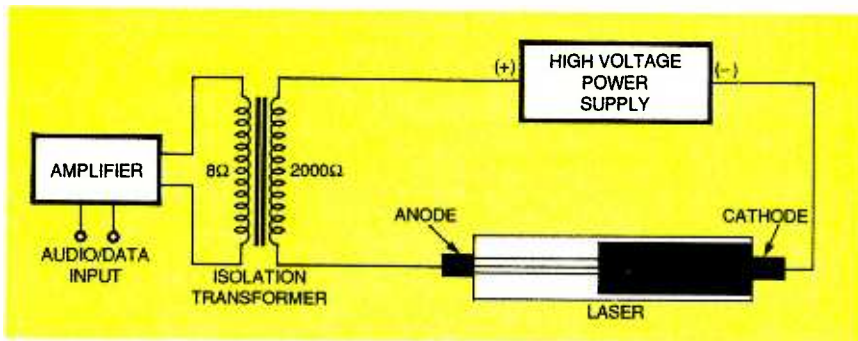

**FIG. 2—ELECTRONIC MODULATION** of a laser beam can be handled in this fashion. Obviously, the transformer you use must be able to handle the high voltage from the laser power supply without breaking down.

onto the surface you want it to strike—a movie screen, wall or ceiling. Now when music or some other audio signal is fed to the speaker, its center vibrates making the spring and mylar vibrate too. The reflected beam will swirl, circle, trace ovals, elongated shapes, and create broken and pulsating lines and patterns (no two designs ever seem to be quite the same. Viewing this produces hours of fasci-

#### HOLOGRAM KITS

##### METROLOGIC INSTRUMENTS, INC.

143 Harding Avenue, P.O. Box 307  
Bellmawr, NJ 08031

##### MIDWEST LASER PRODUCTS

P.O. Box 2187  
Bridgeview, IL 60455  
(708) 460-9595/24p20

nation and relaxation. Even though you have removed the speaker cone, a bit of the audio will be heard. If you want greater volume, don't cut the cone out. If you want to muffle the sound more, put the speaker assembly into an insulated box and cut a small window for the reflected laser beam.

Electronic modulation is the second way to control the output beam. Figure 2 is a block diagram of the setup to vary the intensity of the laser light. The data, sound, or other information to be carried by the beam is fed into the amplifier's input. Its output is connected to the primary of the isolation transformer. The secondary winding is connected in series with the laser's anode lead, between the high-voltage power supply and the laser. The laser's cathode lead remains unchanged. With this arrangement the beam intensity stays constant

when there is no modulating signal. When a signal is applied to the amplifier, the impedance of the isolation transformers primary winding changes and in turn, changes the impedance of the secondary. These changes vary the voltage applied to the laser and make the laser beam brighter or darker. In this way any form of information that can be converted into sound energy can be transmitted over the laser beam.

The amount of change is minute and often cannot be seen by the human eye. That's why a receiver consisting of a photosensitive transistor and amplifier is needed to decode the transmitted information. Figure 3 is the schematic of a simple general-purpose audio amplifier to use as

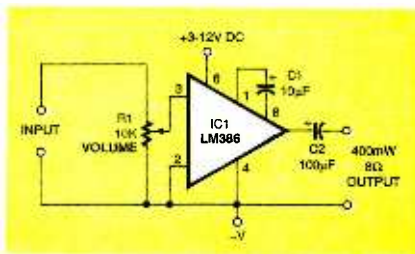

**FIG. 3—SIMPLE IC AMPLIFIER** for increasing gain of the received signal.

either the data input or data decoder. If you don't want to make your own amplifier you can buy a small modular style amplifier package at an electronics distributor. They are self contained, complete with speaker and jacks for input and output.

#### Light-communications experiments

Once you have both a modulator and a receiver, you can use them to make an efficient "free air" light com-

#### TABLE 1—LASER SUPPLIERS

##### American Science and Surplus

3605 Howard Street  
Skokie, IL 60076  
(708) 982-0870

##### Electronics & Computers Surplus City

1490 West Artesia Blvd.  
Gardena, CA 90248  
(310) 217-1922

##### Electronic Rainbow, Inc.

6254 LaPas Trail  
Indianapolis, IN 46268  
(317) 291-7262

##### Information Unlimited

Box 716  
Amherst, NH 03031  
(603) 673-4730

##### Midwest Laser Products

Box 2187  
Bridgeview, IL 60455  
(708) 460-9595

##### MKW Industries

1269 Pomona Road  
Corona, CA 91720  
(800) 356-7714

##### Timeline, Inc.

23605 Telco Avenue  
Torrance, CA 90505  
(301) 784-5488

munications systems. Thanks to the intensity and collimation of the laser beam, these signals can be sent quite a distance, even in bright sunlight.

Beyond the line-of-sight free-air method of transmission, you can try a number of other interesting experiments involving reflecting and receiving laser light. For starters, try aiming the beam at various objects in and around your location. Buildings, windows, automobiles, signs, trees and other plants may amaze you with the variety of reflections they produce. Be sure and try this experiment both during the day and at night, as the results can be quite different. With the help of a friend, you can measure beam divergence or spread at various distances. Make a chart of your measurements and keep it with your laser.

Most 1-mW lasers will project a beam that will reach low clouds, up to about 2,000 feet. At night, the reflection and slight diffusion will create an eerie, almost UFO effect as the clouds move and change shape. Another fascinating observation calls for project-

## ELECTRONIC SUPPLIES OPTICS - MOTORS - HARDWARE

### ACCORD ELECTRONIC SYSTEMS, INC.

1001 West Cypress Creek Road,  
#306-D  
Fort Lauderdale, FL 33309  
(305) 772-2242

### ALL ELECTRONICS CORPORATION

P.O. Box 567  
Van Nuys, CA 91408  
(818) 904-0524

### ALLTRONICS

2300 Zanker Road  
San Jose, CA 95131  
(408) 943-9773

### CIRCUIT SPECIALISTS, INC.

220 South Country Club Drive  
Mesa, CA 85210  
(800) 528-1417

### D C ELECTRONICS

P.O. Box 3203  
Scottsdale, AZ 85271  
(800) 423-0070

### EDMUND SCIENTIFIC

Barrington, NJ

### ELECTRONIC GOLDMINE

P.O. Box 5408  
Scottsdale, AZ 85261  
(602) 451-7454

### EXPRESS PARTS

340 East First Street  
Dayton, OH 45402  
(800) 338-0531

### GATEWAY PRODUCTS CORPORATION

P.O. Box 63-6397  
Margate, FL 33063  
(305) 974-6864

### GATEWAY ELECTRONICS, INC.

8123 Page Blvd.  
St. Louis, MO 63130  
(800) 669-5810

### JDR MICRODEVICES

1850 South 10th Street  
San Jose, CA 95112  
(800) 538-5000

### MARK V ELECTRONICS, INC.

8019 East Slauson Avenue  
Montebello, CA 90640  
(213) 888-8988

### MONDO-TRONICS (MOTORLESS MOTION)

524 San Anselmo Avenue,  
#107-52  
San Anselmo, CA 94960  
(415) 455-9330

### MOUSER ELECTRONICS

2401 Highway 287  
North Mansfield, TX 76063  
(800) 992-9943

### OATLEY ELECTRONICS

P.O. Box 89  
Oatley, Sydney, NSW,  
Australia 2223  
011 61 2 5794985

### OCEAN STATE ELECTRONICS

P.O. Box 1458  
Westerly, RI 02891  
(401) 596-3080

### RADIO SHACK

500 One Tandy Center  
Fort Worth, TX 76102

### RESOURCES UN-LTD

Address not available  
(603) 668-2499  
FAX: (603) 644-7825

## GLOSSARY

**anode**—The positive (+) connection of a laser tube or diode.

**ambient light**—Existing light in and around a location.

**beam**—The narrow light emission from the anode of a laser.

**beam splitter**—An optical device used to divide the beam of light into two beams. Either prisms or partial mirrors.

**cathode**—The negative (-) connection of a laser tube or diode.

**collimation**—The property of laser light that keeps the beam from spreading out as it moves away from the laser.

**collimator**—A lens, or lens assembly that focuses the light into a beam.

**coherence**—The property of laser light where the beam emitted is largely of one frequency or color. In the case of the Helium-Neon laser, this color is red at 632.9 nm.

**concave**—The shape of a negative lens or mirror that allows for the spread of light. The surface curves inward.

**convex**—The shape of a positive lens or mirror that allows for the concentration of light. The surface curves outward.

**diode**—An electronic device that con-

ducts in one direction only. In some applications, it changes alternating current to a pulsating direct current. The positive side of the diode is the anode, and the negative side the cathode.

**electrode**—A metal contact point for electrical connection as in the anode and cathode of the laser.

**electron**—The negatively charged particles of an atom that orbit the nucleus. It's the action of the particles, jumping back and forth in the orbits, that creates the laser light.

**fiber optic**—Plastic or glass rods that transmit light from one end to the other. Allows for bending of the beam.

**focus**—Also referred to as focal point, it is the distance from a lens, or lens assembly, where the light comes to a point or apex.

**helium**—The elemental, inert gas with atomic number 2 and the symbol He.

**hologram**—A photograph, made with laser light that appears to have three dimensions.

**holography**—The science and technique of producing holograms.

**infrared (IR)**—A form of electromagnetic radiation, between visible red and the microwave range, with a frequency of 780 nm to 100,000 nm.

**laser**—An acronym for Light Amplification by Stimulated Emission of Radiation. This electrical or mechanical device produces a very straight and narrow beam of light, usually visible, of one dominant color.

**nanometer (nm)**—A term used to describe the wavelength of light, it is equal to a  $1 \times 10^{-9}$  meter.

**neon**—The elemental, inert gas with atomic number 10 and the symbol Ne.

**optics**—Any device used to control or manipulate light. Usually made of glass or plastic, these include lenses, mirrors, prisms, and filters.

**photon**—A quantum of light emitted by any source.

**population inversion**—The condition when more atoms are in an upper energy level than in a lower one.

**refraction**—The bending of light at the boundary of two surfaces.

**spectrum**—The entire range of electromagnetic energy. When applied to light, and/or lasers, it includes the frequencies from short wave ultraviolet through infrared energy.

**ultraviolet (uv)**—Light, invisible to the eye, from purple up, beginning at about 400 nm.

**visible light**—Electromagnetic radiation, from about 400 nm to 880 nm,

**HOLOGRAPHIC SUPPLIES**

**AGFA-GAVAERT**  
**(FILM TYPE-10E)**  
 75 275 North Street  
 Teterboro, NJ 07608

**EASTMAN CHEMICAL**  
**PRODUCTS, INC.**  
 200 South Wilcox Drive  
 Kingsport, TN 37662  
 (615) 229-2000

**FREESTYLE PHOTO**  
 5120 Sunset Blvd.  
 Los Angeles, CA 90027  
 (800) 292-6137

**INTEGRAF**  
 745 North Waukegan Road  
 Lake Forrest, IL 60045  
 (312) 234-3756

**NEWPORT CORPORATION**  
 18235 Mount Baldy Circle  
 Fountain Valley, CA 92708  
 (714) 962-7701

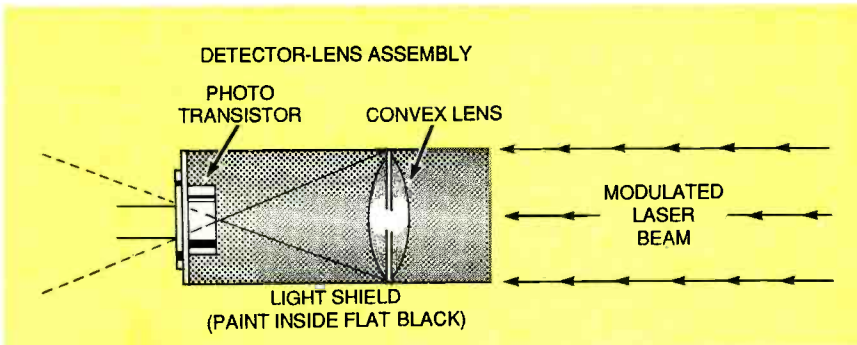

**FIG. 4**—DETECTOR-LENS ASSEMBLY is housed inside a tube that will fit the lens.

ing the beam through rain drops at night. Shining the beam out across a field during a mild rain shower is a very pretty sight, even during daylight. The same applies to fog. With the right angle, the beam will be visible only in the areas where it encounters the fog.

While you bounce the beam off various surfaces, you will probably notice that the light sometimes reflected back towards the source. The intensity of the reflection depends on the surface of the reflector. This property is what makes the next three experiments work. In each one a form of modulation comes into play. Once you can receive a returning beam of varying strength you can transfer information and, at the same time, demonstrate the principle of data transmission via reflector movement.

Because the reflected light is less intense, you will need a more sensitive receiver. You will also need an with considerably higher gain. The detector assembly has to be far more efficient in collecting the returning light and concentrating it on the photo-transistor. The problem of light collection/concentration can be solved by using a combination light shield and

lens holder (see Fig. 4).

You can make one from either a cardboard, plastic, or metal tube. When properly focused, this lens condenses the collected light into a small spot on the photo-sensitive surface of the detector. If you need more sensitivity, use a cluster of phototransistors wired in parallel. Figure 5 shows how that is done. With the lens focused appropriately, this can be used to increase the photosensitive area. Paint the inside of the tube flat black to reduce ambient light interference. If this still does not adequately increase sensitivity, install a medium-

sive gain. By feeding the output of the first stage into the inverting (negative) input of stage two, amplification is increased further. Stages three and four also boost gain. Potentiometer R10 is the final volume control for the signal being fed to the speakers or

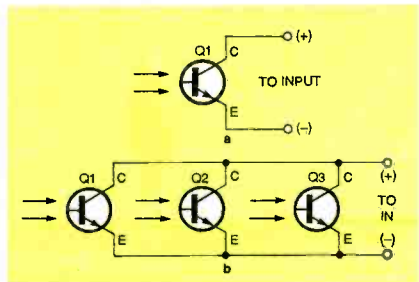

**FIG. 5**—SINGLE PHOTOTRANSISTOR used as laser modulation detector is shown in a. When more sensitivity is needed, multiple phototransistors can be connected as shown in b.

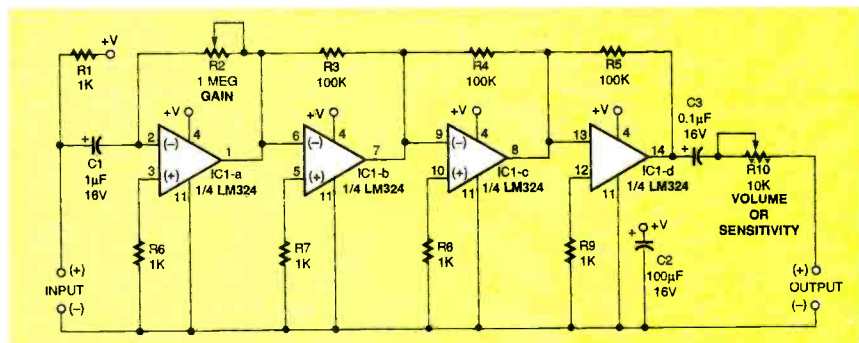

**FIG. 6**—FOUR-STAGE HIGH-GAIN amplifier uses a single LM324 quad amplifier.

density red filter at the front of the tube. Since the HeNe (Neon Helium) beam is red, it passes through the filter while green and blue light are rejected. This should reduce the ambient light to one third of its strength without the filter.

The amplifier shown in Fig. 6 is a four-stage, operational amplifier (op-amp) circuit wired in a cascade arrangement. Potentiometer R2 acts as the gain control for the initial amplifier stage. It serves two functions. First it helps set volume. Second it inhibits distortion that might otherwise be caused by exces-

sive gain. The final output can also be connected to a relay or some alarm device. If this is done, R10 acts as a sensitivity control.

Once the detector and amplifier are completed, mount the LM324 circuit in a small project box. Position the detector assembly on the outside so it can be aimed at the returning light beam. The amplifier is powered by a standard 9-volt battery. Mount an on-off toggle switch and an "on" indicator, together with an output jack, on the project box.

You are now ready to start working on some practical projects.

# Making Voltage Measurements with a DSO

**B**ECAUSE THE OSCILLOSCOPE ALLOWS YOU TO ACTUALLY "SEE" WHAT YOU ARE MEASURING, IT IS AN INVALUABLE MEASUREMENT AID AND HAS LONG BEEN A MAINSTAY IN THE ENGINEERING TOOLBOX. TODAY,

the digital storage oscilloscope (DSO) will help you make voltage measurements with a higher degree of accuracy and ease than ever before.

## Types of voltage measurements

Voltage can be defined as the electric potential between two points in a circuit. Typically, one of those points is earth ground, that is, zero volts. Two types of voltage measurements—absolute and amplitude—comprise the majority of voltage measurements you will be making with your DSO.

A DC voltage measurement between ground and a second point in the circuit is called an *absolute voltage measurement*. An *amplitude measurement*, conversely, is a peak-to-peak AC voltage measurement on a signal found at the second test point. Both absolute voltage and voltage amplitude measurements use the vertical axis on your oscilloscope display. The instrument's vertical scale control sets the range for voltage measurements.

Voltage amplitude includes both amplitude and peak-to-peak (often abbreviated as "Pk-Pk" or P-P) measurements. Both of these are

\*Ed Caryl is an Application Engineer/Product Support Specialist at Tektronix, Inc.

taken from the waveform top to its bottom. Peak-to-peak measurements include any noise, spikes, or overshoot on the waveform. A scope can be set to ignore those factors if it has a Histogram High-Low setup function. The reference is always the low point on the waveform.

## Voltage measurement applications

You are making *amplitude* measurements if you measure the peak-to-peak ripple on a power supply or the peak-to-peak voltage on an AC motor. If you need to determine the total peak-to-peak voltage at a test point in a logic circuit, or the peak-to-peak voltage developed by a pressure transducer, you also will be making amplitude measurements.

*Absolute* voltage measurements include the maximum (Max), minimum (Min), mean, high, and low measurement of a voltage. Max is

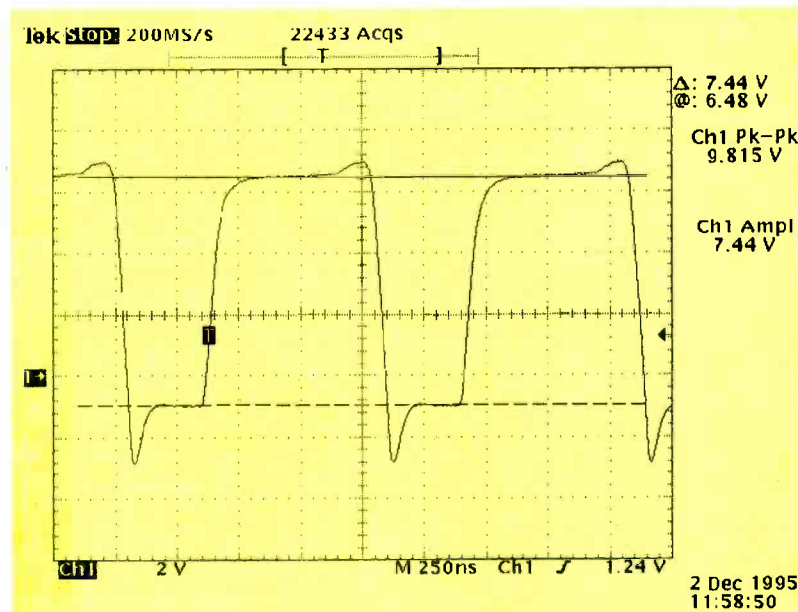

**Fig. 1**—THREE AMPLITUDE AND TWO ABSOLUTE voltage measurements are shown above. The oscilloscope's measurement system has made both a peak-to-peak and an amplitude measurement. For the absolute measurements, the active (@) cursor is making one absolute measurement at the waveform top. Secondly, the peak absolute value can be read from the graticule at about 7 volts (3.5 divisions at 2 volts/division). Earth ground is one division below graticule center, as marked by the 1→ symbol.

the positive peak voltage, while Min is the negative peak voltage. These measurements are referenced to earth ground.

You would make absolute voltage measurements if you needed to determine, for example, the mean value for a power supply output or the peak start-up current required by an AC motor. You would also use absolute voltage measurements to verify battery voltage or the logic levels in digital logic circuits.

### Three ways to make voltage measurements

There are three ways to measure voltage. First, most DSOs have menu-selectable, *automatic measurement functions* that will make the measurements for you (Figure 1). These measurements are derived directly from waveform data and are the most accurate voltage measurements you can make—if the oscilloscope is set up properly.

To ensure proper setup, you must configure the oscilloscope to provide the highest vertical resolution possible. Select the highest sensitivity, spreading the waveform over the greatest vertical amplitude. The tradeoff, however, is that you lose the ability to know exactly where your measurement is derived from on the waveform.

*Voltage cursors* provide the second measurement method (Figure 1). These measurements are derived from waveform data, but are subject to operator error. To achieve accuracy, you must align the cursors with the exact waveform points intended. If your DSO has a zoom function, you can magnify the waveform features to make it easier to place the cursors correctly. Voltage cursors provide the benefit of indicating where your measurement is being made on the waveform.

The third measurement method is aligning the waveform with the displayed graticule markings, then counting divisions, and multiplying the answer by the vertical readout sensitivity. This is the casual *eyeball method* you probably are accustomed to using (Figure 1) when you operate an oscilloscope.

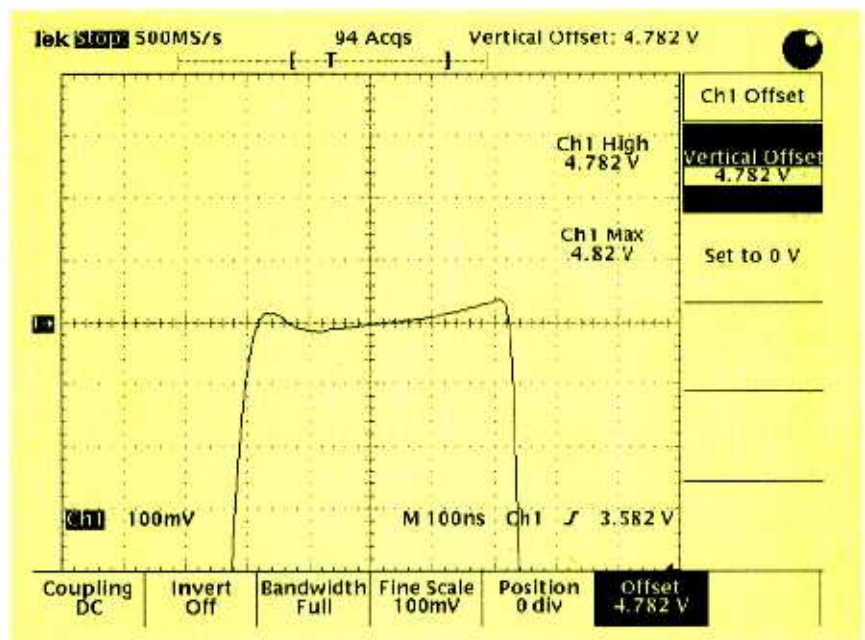

**FIG. 2— AN ABSOLUTE VOLTAGE MEASUREMENT USING OFFSET** is shown above. The offset voltage is the vertical difference between earth ground and graticule center. This has been set to coincide with the High value measured by the oscilloscope measurement system. The Max measurement is reading the peak value. The instrument has a  $\pm 2\%$  AC gain error, but using offset, the error specification on these measurements is reduced to  $\pm 1.23\%$ .

### Specifications that affect measurement accuracy

There are four oscilloscope specifications that impact voltage measurement accuracy: vertical-gain accuracy, DC-balance accuracy, offset-voltage accuracy, and vertical resolution.

*Vertical-gain accuracy* is typically measured using DC voltages, and thus is usually called “DC-gain accuracy.” This is confusing because gain accuracy most affects AC, peak-to-peak, and amplitude measurements. Vertical-gain errors typically come from vertical attenuators, amplifiers, and, in DSOs, from analog-to-digital converters (ADCs).

There are two ways to specify DC gain accuracy: as a full-scale display amplitude percentage, or as a measured value percentage. Most amplitude measurements are made at less than full scale, usually from four to six divisions. If full scale is eight divisions, two percent of full scale equals four percent of four divisions. If the gain accuracy is a measurement error percentage — in other words, a percent of reading— then two percent remains two percent for all measurements.

*DC-balance accuracy* is a factor in all

push-pull amplifiers such as those used in oscilloscopes. A push-pull amplifier amplifies a signal that moves both above and below ground or zero potential. DC-balance accuracy is the difference between earth ground and the level that the instrument interprets as earth ground. This specification affects all measurements where ground is the reference, e.g., absolute voltage measurements.

DC balance is quite dependent on temperature, but all oscilloscopes have some way to adjust it. In Tektronix DSOs, for example, DC balance is performed during Signal Path Compensation (SPC). This routine is found in the Utility menu, under Cal (Calibration). It will typically restore DC balance to less than one-tenth division error. If necessary, the remaining error can be quantified by simply grounding the input and examining where the baseline trace falls. If you are routinely making high precision DC measurements, you should run SPC at least once a week.

*Offset* is a precision internal voltage source used to offset a signal level. It can be used to position a small DC signal (such as ripple signals found on power supplies) on-screen to enable

amplification and a more accurate measurement of the signal. Offset also can be used as a nulling voltmeter by placing the measured level at the center horizontal graticule line.

*Vertical resolution* is set by the ADC and the acquisition mode. Eight-bit ADCs are the most common. This means there are two-to-eighth-power ( $2^8$ ) voltage levels in the vertical resolution, 256 levels available to represent signal amplitudes. These levels are distributed over either 8 or 10.24 vertical divisions, the total vertical "dynamic range." If signal averaging, HiRes (high resolution), or other signal processing features are used, the vertical memory is extended to 16 bits. The practical limit using these higher resolution techniques is 12 to 13 bits, as set by internal instrument noise.

### Measurement type vs. specification

Some DSO manufacturers lump all of the previously mentioned accuracy components into one specification, usually called "DC accuracy." This practice makes it difficult to design the method of your measurements in order to improve accuracy with special techniques or to determine the real errors.

Vertical gain error and resolution are the only error factors to consider when making amplitude or peak-to-peak measurements. You need not consider offset and DC balance accuracy. If the waveform is repetitive (a requirement of peak-to-peak measurements), use signal averaging to reduce noise. Or, if noise is to be included in the measurement, use peak detect acquisition mode (if available) to detect the noise. If signal averaging is used, only the vertical gain error affects your measurements.

When the signal is single-shot, or if you employ Peak Detect, add the gain error and resolution. The resolution will be plus or minus one digitizing level (DL). An instrument with an eight-bit ADC and 8 divisions dynamic range has 32 DLs per division. The 10.24 divisions of dynamic range in Tektronix DSOs result in 25 DLs per division. The display resolution in Tektronix DSOs is 50 levels-per-division, or 9 bits. Signal-averaged or

HiRes waveforms will be displayed at this 9-bit resolution. If your oscilloscope has a zoom feature, you can employ it to see up to 13-bit resolution.

Resolution is the key to precise amplitude measurements. Use all of the DSO's dynamic range possible without clipping the waveform. Then use signal averaging or HiRes mode if your instrument provides this capability.

Absolute voltage measurement accuracy is a combination of gain, DC balance, and offset accuracy. On many DSOs, the accuracy calculation is complex if the measured voltage level is not located at center screen. The accuracy calculation is much simpler if you use the offset control voltage to bring the measured level to the center horizontal graticule line. At this point, only DC balance and offset accuracy are important. The offset control voltage is very precise—plus or minus 0.2 or 0.4 percent in Tektronix instruments. Don't be afraid to overdrive the oscilloscope by running the unmeasured waveform parts off screen (Figure 2).

### Summary

The oscilloscope has more than earned its reputation as an essential tool in the electronics toolbox. As we've seen, the DSO in particular brings many advantages to making voltage measurements, including zoom and automatic measurements. Just remember, for the most accurate amplitude voltage measurements, be sure to use the maximum resolution your DSO provides. Also, take advantage of your oscilloscope's full dynamic range, and, when noise is present, employ the signal averaging or HiRes mode. For absolute voltage measurements, the offset feature will help ensure a higher degree of accuracy. Finally, whenever possible, let the oscilloscope make the measurement with the automatic measurements capability that most DSOs now provide.

*Readers can contact Tektronix by calling 1-800-479-4490, Action Code 300. Additionally, Tektronix maintains a home page at:*

<http://www.tek.com/Measurement>. **EN**

## TIPS FOR MAIL ORDER PURCHASE

**It is impossible for us to verify the claims of advertisers, including but not limited to product availability, credibility, reliability and existence of warranties. The following information is provided as a service for your protection. It is not intended to constitute legal advice and readers are advised to obtain independent advice on how to best protect their own interests based upon their individual circumstances and jurisdictions.**

**1. Confirm price and merchandise information** with the seller, including brand, model, color or finish, accessories and rebates included in the price.

**2. Understand the seller's return and/or refund policy**, including the allowable return period, who pays the postage for returned merchandise and whether there is any "restocking" or "return" charge.

**3. Understand the product's warranty.** Is there a manufacturer's warranty, and if so, is it for a U.S. or foreign manufacturer? Note that many manufacturers assert that, even if the product comes with a U.S. manufacturer's warranty, if you purchase from an unauthorized dealer, you are not covered by the manufacturer's warranty. If in doubt, contact the manufacturer directly. In addition to, or instead of the manufacturer's warranty, the seller may offer its own warranty. In either case, what is covered by warranty, how long is the warranty period, where will the product be serviced, is there a charge for service, what do you have to do to obtain service and will the product be repaired or replaced? You may want to receive a copy of the written warranty before placing your order.

**4. Keep a copy of all transactions**, including but not limited to cancelled check, receipt and correspondence. For phone orders, make a note of the order including merchandise ordered, price, order date, expected delivery date and salesperson's name.

**5. If the merchandise is not shipped within the promised time**, or if no time was promised, within 30 days of receipt of the order, you generally have the right to cancel the order and get a refund.

**6. Merchandise substitution** without your express prior consent is generally not allowed.

**7. If you have a problem with your order or the merchandise**, write a letter to the seller with all the pertinent information and keep a copy.

**8. If you are unable to obtain satisfaction from the seller**, contact the consumer protection agency in the seller's state and your local Post Office.

**If, after following the guidelines, you experience a problem with a mail order advertiser that you are unable to resolve, please let us know. Write to Advertising Department, Gernsback Publications Inc., 500B BI-County Blvd. Farmingdale, NY 11735.**

**Be sure to include copies of all correspondence.**

# Electronics Experimenters' Books



**PCP116—Introducing Digital Audio—CD, DAT and Sampling...\$10.00.** Digital audio involves methods and circuits that are totally alien to the technician or inquiring amateur who has previously worked with audio circuits. This book is intended to bridge the gap! The principles and methods are explained, but the mathematical background and theory are avoided when practical.



**BP325—A Concise User's Guide to Windows 3.1...\$7.95.** If you are having trouble with Windows 3.1, then discover how to manipulate Windows screens and how to run Windows and DOS applications under the Windows Graphic User Interface (GUI) environment. There's more: the word processor (Write), Program Manager, File Manager and Print Manager will be mastered by you. The text's scope is enormous.



**BP233—Electronic Hobbyists Handbook...\$9.95.** A collection of data for the amateur electronics enthusiast. The text includes data on a multitude of topics such as parts color codes, integrated circuit pin-outs, transistor lead-out diagrams and data, basic circuit building blocks, and much more. Where appropriate, detailed background information and explanatory notes are provided.

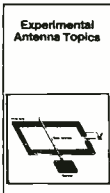

**BP278—Experimental Antenna Topics...\$5.95.** Contains 28 fascinating sections and includes many unusual practical antenna designs that use such outlandish materials as cardboard, aluminum foil, plastic bottles, cat-food cans, etc., even water!



**PCP104—Electronics—Build and Learn...\$9.95.** Construction details are given to build a circuit demonstrator that is used throughout the book to introduce common electronic components and how these components are built up to useful circuits.



**BP287—A Reference Guide to Practical Electronics Terms...\$8.95.** A companion volume to BP286. Covers the more practical and applied aspects of electronics. An essential reference work for the library of all those interested in electronics.



**PCP118—MIDI Survival Guide...\$7.75.** The book offers practical advice on starting up, setting up, and ending up with a practical MIDI system. Includes over 40 cabling diagrams and tips on connecting synths, sound modules, sequencers, etc.



**PCP117—Electronic Projects for Guitar...\$12.95.** If you are a guitarist, you'll find this collection of 16 guitar and general-purpose effects projects extremely useful at bargain do-it-yourself prices. Each project has an introduction, an explanation of how it works, complete instruction on stripboard layout and assembly, as well as notes on setting it up and using. Written for the beginner project builder.



**BP256—Introduction to Loudspeakers and Enclosure Design...\$5.95.** All you need to know about the theory and operation of loudspeakers (drivers) and the various types of enclosures (boxes) into which they should be built. Crossover units are covered. Also includes the complete design and construction details of how to make an inexpensive but high-quality enclosure called the "Kapellmeister."

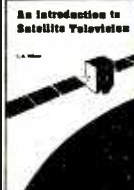

**BP195—An Introduction to Satellite Television...\$9.95.** As an introduction to satellite television this book is presented on two levels. For the absolute beginner with no previous knowledge, the story is told as simply as it can be in the main text. For the professional engineer, student or others with technical backgrounds, there are numerous appendices backing up the main text with additional technical and scientific details.



**BP275—Simple Shortwave Receiver Construction...\$6.95.** Contains practical designs for building a number of simple shortwave receivers. Comprehensive plans include diagrams and full coil-winding details where necessary.

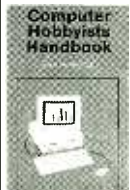

**BP251—Computer Hobbyists Handbook...\$8.95.** Provides a single, quick reference source to bountiful data and information that the computer hobbyist will find useful. An absolutely essential addition to your bookshelf that will become a reference text.



**BP162—Counting on QL Abacus...\$4.95.** Shows the reader how to get the maximum use from the enormously powerful QL Abacus which is a practical spreadsheet-type of program. Useful for presenting information and data.



**BP58—50 Circuits Using 7400 Series IC's...\$5.50.** Interesting and useful circuits and applications that cover many different aspects of electronics using this readily freely obtainable, inexpensive and fantastically versatile series of devices.

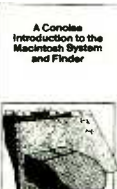

**BP298—A Concise Introduction to the Macintosh System and Finder...\$6.25.** If you have one of the popular Macintosh range of computers, this book is designed to help you get the most from it. Although the Mac's WIMP user interface is designed to be easy to use, much of it only becomes clear when it is explained in simple terms. All Macintosh computers are covered including the new "Classic" range.



**BP101—HOW TO IDENTIFY UNMARKED IC's...\$2.25.** A chart that shows the reader how, with just a multimeter, to go about recording the particular signature of an unmarked IC which should enable the IC to then be identified. By now you are probably wondering what an IC signature is. It is a specially plotted chart produced by measuring the resistances between all terminal pairs of an IC.



**PCP114—Advance MIDI User's Guide...\$14.95.** Although still regarded by many as nothing more than a way to get one instrument to follow the playing of another, MIDI actually has capabilities that go well beyond the simple slaving arrangement. This splendid book explains all the MIDI messages, routing MIDI in simple to advanced systems, explains how to troubleshoot when things go wrong, and much more.

## Bargain Table Best Buys for Experimenters and Computer Buffs

- |   |   |
|---|---|
| <input type="checkbox"/> BP106—Modern Opamp Projects.....\$5.75                     | <input type="checkbox"/> BP195—An Introduction to Satellite Television.....\$6.25   |
| <input type="checkbox"/> BP137—BASIC and FORTRAN in Parallel.....\$3.95             | <input type="checkbox"/> BP198—An Introduction to Antenna Theory.....\$6.95         |
| <input type="checkbox"/> BP138—BASIC and FORTH in Parallel.....\$3.95               | <input type="checkbox"/> BP248—Test Equipment Construction.....\$5.95               |
| <input type="checkbox"/> BP154—An Introduction to MSX BASIC.....\$4.95              | <input type="checkbox"/> BP249—More Advanced Test Equipment Construction.....\$6.95 |
| <input type="checkbox"/> BP169—Hot to Get Your Computer Programs Running.....\$5.95 | <input type="checkbox"/> BP260—A Concise Introduction to OS/2.....\$4.95            |
| <input type="checkbox"/> BP194—Modern Opto Devices Projects.....\$6.25              | <input type="checkbox"/> BP263—A Concise Introduction to dBASE.....\$6.95           |

**ELECTRONIC TECHNOLOGY TODAY INC.**  
P.O. BOX 240, Massapequa, NY 11762-0240

Name \_\_\_\_\_  
Address \_\_\_\_\_  
City \_\_\_\_\_ State \_\_\_\_\_ Zip \_\_\_\_\_  
EN3 Allow 6-8 weeks for delivery

**SHIPPING CHARGES IN USA AND CANADA**  
\$0.01 to \$5.00.....\$2.00  
\$5.01 to \$10.00.....\$3.00  
\$10.01 to 20.00.....\$4.00  
\$20.01 to 30.00.....\$5.00  
\$30.01 to 40.00.....\$6.00  
\$40.01 to 50.00.....\$7.00  
\$50.01 and above.....\$8.50

**SORRY** No orders accepted outside of USA & Canada

Total price of merchandise..... \$ \_\_\_\_\_  
Shipping (see chart)..... \$ \_\_\_\_\_  
Subtotal..... \$ \_\_\_\_\_  
Sales Tax (NYS only)..... \$ \_\_\_\_\_  
Total Enclosed..... \$ \_\_\_\_\_

Number of books ordered

**All payments must be in U.S. funds!**



## L/C METER

continued from page 32

It can be seen that the impedance increases with increasing  $L$  or  $Q$  and decreases with increasing  $C$ . Higher impedances develop higher voltages across the tank in the oscillator circuit described above, while lower impedances develop lower voltages. The maximum value of  $L$  is determined by the upper limit of 2.5 volts peak-to-peak while the maximum value of  $C$  is determined by the lower limit of 2 to 10 millivolts. For the oscillator described above, these limits are approximately 200 millihenrys and 2.0 microfarads, but they are also a function of the  $Q$  of the inductors or capacitors. The L/C meter's top range is specified at 100 millihenrys and 1 microfarad, but values up to the maximum limits mentioned above can usually be measured depending upon their  $Q$ . Capacitors must be non-polarized.

### The microcontroller

If the oscillator is the heart of the L/C meter, then IC2, a PIC16C61 microcontroller, is its brain. The PIC16C61 is an advanced version of the familiar PIC16C54 18-pin microcontroller from Microchip Technology. The 16C61 has a 14 bit instruction that allows CALLS and GOTOs to anywhere in its 1024-instruction program memory without the page management overhead of the 16C54. It has 36 bytes of RAM and an eight level deep stack rather than the two level stack of the 16C54. The outputs can sink or source up to 20 milliamperes, allowing it to drive LEDs or, in

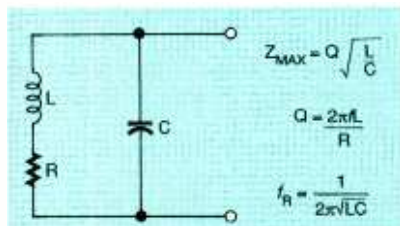

FIG. 2—THE OSCILLATOR'S OPERATION can be best understood by examining this simplified equivalent circuit of a parallel-resonant tank.

TABLE 1—DISPLAY OPTIONS

Inductance	Capacitance (jumper shorted)	Capacitance (jumper open)
0.000 - 0.999 $\mu$ H	0.00 - 0.99 pF	0.00 - 0.99 pF
1.000 - 9.999 $\mu$ H	1.00 - 9.99 pF	1.00 - 9.99 pF
10.00 - 99.99 $\mu$ H	10.00 - 99.99 pF	10.00 - 99.99 pF
100.0 - 999.9 $\mu$ H	100.0 - 999.9 pF	100.0 - 999.9 pF
1.000 - 1.999 mH	1.000 - 9.999 nF	1000 - 9999 pF
10.00 - 99.99 mH	10.00 - 99.99 nF	.0100 - .0999 $\mu$ F
100.0 - 999.9 mH *	100.0 - 999.9 nF	.1000 - .9999 $\mu$ F
1.000 - 9.999 H **	1.000 - 9.999 $\mu$ F *	1.000 - 9.999 $\mu$ F *

\* Programmed into the computer but some values may be out of range.

\*\* Programmed into the computer but out of range.

the case here, a reed relay. It also has interrupts which are not used in L/C meter. Another useful feature is built-in pull-up resistor on the inputs which helps reduce the parts count.

The output of the oscillator is applied to the RTCC REAL-TIME CLOCK COUNTER pin. This increments an 8-bit counter inside the microcontroller. The microcontroller accumulates the count for a period of 0.2 seconds. Discrete signals from the  $L_x$ ,  $C_x$ , and ZERO switches are input to the microcontroller so it knows what the operator wishes it to do. Seven outputs are used to drive the intelligent LCD display

which is operated in its 4-bit (nibble) mode. Four of the outputs are data bits (D4-D7), one is REGISTER SELECT (RS), one is READ/WRITE (R/W) and the last is ENABLE (ENB). One input pin is a jumper which provides two ways to display capacitance values as shown in Table 1.

The jumper-shortened option is for those more inclined toward metric units who want capacitances specified in nanofarads, when appropriate. The jumper-open is for old timers like me, who prefer only picofarads and microfarads. That option has one less digit of resolution in the .0100 to 0.999 range.

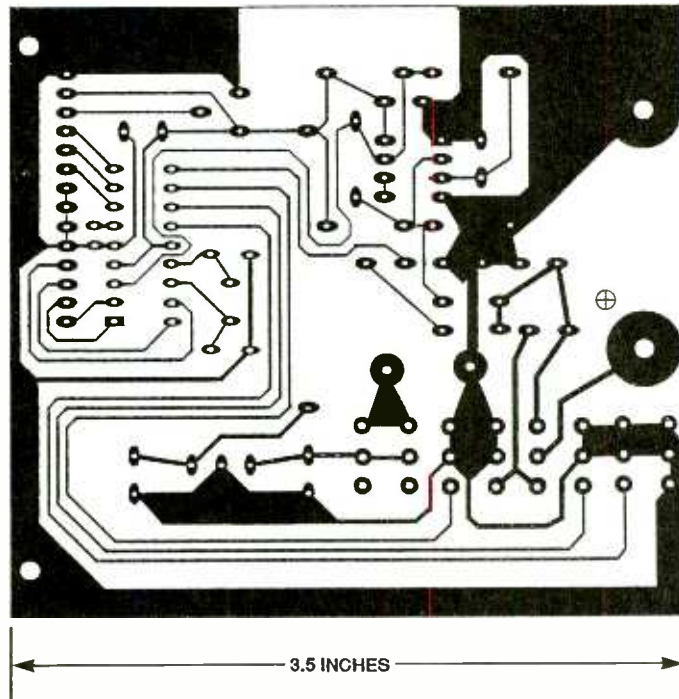

FULL-SIZE L/C METER foil pattern.

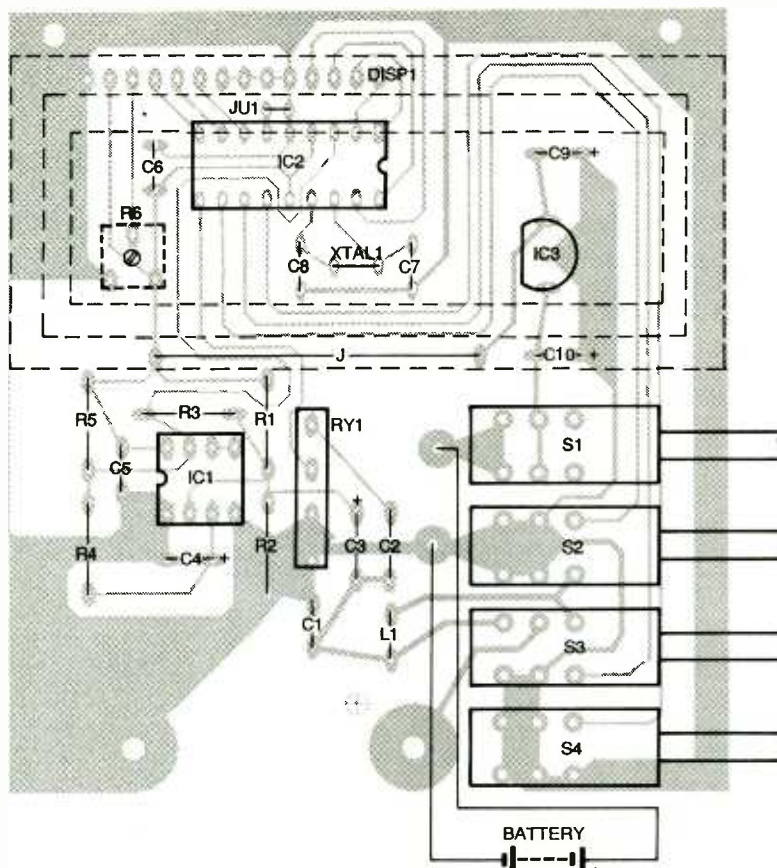

**FIG. 3—PARTS PLACEMENT DIAGRAM.** Be sure to mount R6 on the rear of the board so you can adjust the display's contrast after the display is installed.

### Self-calibrating

One of the truly unique attributes of the L/C meter is that it is self-calibrating. It's really a "put it together and it works"

project. That is, if all the parts are in the right place and you do a good job of soldering, then it will work.

During the calibrate cycle the

microcontroller first measures  $f_1$ , the frequency when only L1 and C1 are in the tank circuit. The frequency will be:

$$f_1 = \frac{1}{2\pi\sqrt{L1C1}}$$

This is one equation with two unknowns and therefore cannot be solved for L1 and C1. To obtain another equation, a known capacitor is switched into the tank circuit. The microcontroller raises the CALIB line to a logic high level. This energizes relay RY1, which switches capacitor C2 (a 1000-pF, 1% polystyrene capacitor) into the tank circuit. That causes the frequency to become:

$$f_2 = \frac{1}{2\pi\sqrt{L1(C1 + C2)}}$$

The two equations can be solved simultaneously to give:

$$C1 = \frac{f_2^2}{f_1^2 + f_2^2} C2$$

and finally:

$$L1 = \frac{1}{4\pi^2 f_1^2 C1}$$

Because of this self-calibration capability, the exact values of L1 and C1 are not critical and components with tolerance ratings of 10% are used. The accuracy of the device is dependent upon C2 which is a capacitor with a tolerance rating of 1%..

### PARTS LIST

All fixed resistors are ¼ watt, 5%

- R1, R2, R3—100,000 ohms
- R4—47,000 ohms
- R5—1000 ohms
- R6—10,000 ohms, potentiometer

#### Capacitors

- C1—680 pF ceramic disc
- C2—1000 pF, 2% (Mouser 140-PF2A102F or equiv.)
- C5, C6—0.1 μF, ceramic disc
- C3—10 μF, 10 volts, Tantalum
- C4, C9, C10—10 μF, 10 volts, electrolytic
- C7, C8—20 pF, ceramic disc

#### Semiconductors

- IC1—LM311N voltage comparator
- IC2—PIC16C61 microcontroller (Microchip Technology)
- IC3—78L05 voltage regulator

#### Other Components

- XTAL1—4.0 MHz crystal (Digi-Key X006 or equiv.)

L1—68 mH (Mouser 434-1120-680L or equiv.)

RY1—SPST N.O. reed relay (Hamlin HE3621A0500 or equiv.)

DISP—LM-16151 (Digi-Key OP116 or equiv.)

J1—14 pin square post socket (Digi-Key 929974-01-36 or equiv.)

P1—14 pin square post plug (Digi-Key S1022-36 or equiv.)

S1, S2, S3—DPDT alternate action switch (Digi-Key EG1001 or equiv.)

S4—DPDT momentary switch (Digi-Key EG1002 or equiv.)

Miscellaneous: case (PacTec HP9VB), 5-way binding posts, hardware.

**Note:** The following are available from: Almost All Digital Electronics, 1412 Elm St. S.E.,

Auburn, WA 98092

(206-351-9316):

- Disk containing source and object code: \$19.95 (includes free copy of MPASM, PIC assembler, and MPSIM, PIC simulator)

- Programmed IC2: \$29.95

- Hard-to-find parts kit: \$49.95 (includes printed-circuit board, all switches with buttons, L1, C1, C2, RLY1 and U2)

- Complete kit: \$79.95 (includes machined case with panel decal)

- Assembled unit: \$99.95

Include \$4.00 shipping and handling per order. Add and additional \$4.50 on C.O.D. orders. Washington State residents add 8% sales tax

## LISTING 1

```

INITIALIZE THE CPU AND I/O PORTS
INITIALIZE THE LCD DISPLAY
WHILE Lx OR Cx are ON
    DISPLAY "SWITCH ERROR"
WEND
(The computer cannot calibrate itself if Lx or Cx are on. The unit
waits for the operator to clear the switches.)
DISPLAY "WAIT" (wait 10 seconds for the oscillator to stabilize.)
CALIBRATE:
    DISPLAY "CALIBRATING"
    MEASURE F1
    SWITCH IN THE CALIBRATION CAPACITOR
    MEASURE F2
    SWITCH OUT THE CALIBRATION CAPACITOR
    COMPUTE C1=F2^2 / (F1^2 - F2^2) C2
    COMPUTE L1=1 / (4 p^2 F1^2 C1)
DO (loop continuously)
    IF Lx and Cx are OFF
        IF ZERO
            GOTO CALIBRATE (re-calibrate the unit)
        ELSE
            DISPLAY "READY" (ready to measure Lx,Cx,or be ZEROed)
            MEASURE and STORE F1
        END IF
    ELSEIF Lx ON AND Cx OFF
        MEASURE F2
        IF ZERO ON
            MEASURE and STORE F1
            DISPLAY "0.000"
        ELSE (ZERO OFF)
            COMPUTE Lx=(F1^2 / F2^2 -1) L1
            DISPLAY "Lx="
            DISPLAY VALUE in engineering units
        END IF
    ELSEIF Cx ON AND Lx OFF
        MEASURE F2
        IF ZERO ON
            MEASURE and STORE F1
            DISPLAY "0.000"
        ELSE (ZERO OFF)
            COMPUTE Cx=(F1^2 / F2^2 -1) C1
            DISPLAY "Cx="
            DISPLAY VALUE in engineering units
        END IF
    ELSE (Lx and Cx both ON)
        DISPLAY "SWITCH ERROR"
    END IF
LOOP

```

The unit can be re-calibrated by pressing ZERO when  $L_x$  and  $C_x$  are both off. This may be desirable when measuring very small values. In such cases, the unit should be allowed to warm up for about 5 minutes to allow the oscillator to thermally stabilize.

### Making measurements

When the  $L_x$  and  $C_x$  switches are off, the microcontroller con-

tinuously measures  $f_1$  to track any drift in frequency. When the  $L_x$  switch is depressed, the unknown inductor is placed in series with  $L_1$ . The total inductance is then  $L_1 + L_x$ . This causes the frequency to change to:

$$f_2 = \frac{1}{2\pi\sqrt{(L_1 + L_x) C_1}}$$

This equation can be solved, si-

multaneously with the equation for  $f_1$  to produce:

$$L_x = \left[ \frac{f_1^2}{f_2^2} - 1 \right] L_1$$

Similarly when the  $C_x$  switch is depressed the unknown capacitor is placed in parallel with  $C_1$ . The total capacitance is then  $C_1 + C_x$ .

$$f_2 = \frac{1}{2\pi\sqrt{L_1 (C_1 + C_x)}}$$

## A DESIGN THAT IMPROVES WITH AGE

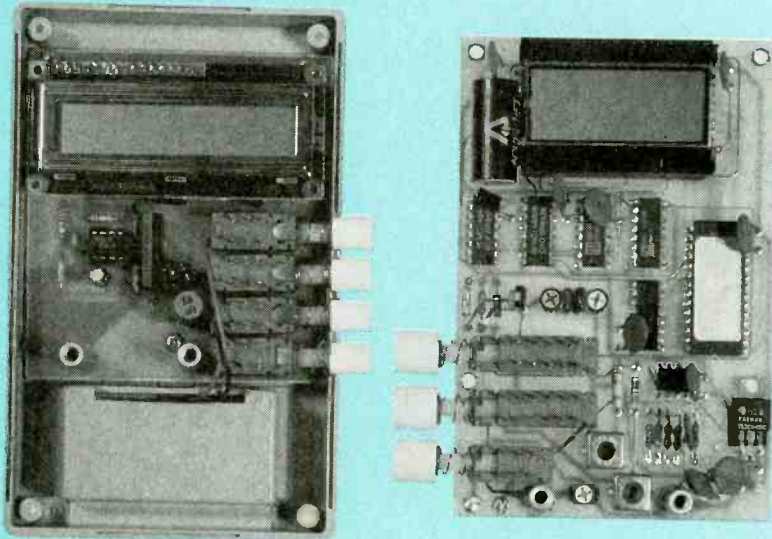

THE NEW L/C METER is shown on the left, mounted in its case. The original version's PC board is shown on the right. Note how the PC board size and complexity have been reduced greatly.

In July of 1988, *Radio-Electronics* magazine (*Electronics Now's* predecessor) presented the L/C Meter I. It measured inductance and capacitance by detecting the shift in frequency of an oscillator when an unknown is inserted into its tank circuit. At that time it was postulated that a microcontroller would be the best solution to the computation and display of the result. However, there were no inexpensive microcontrollers available back in 1988. Instead a ROM look-up table approach was used.

That was 1988, this is 1996 and the Micochip Technology's series of PIC mi-

crocontrollers allows the use of a microcontroller in this version of the L/C Meter. The result is increased resolution and range as well as intelligent display of the result in engineering units. The technique and the oscillator circuit are essentially the same as original L/C Meter, which had 12 ICs and an LCD display. This updated version uses only 3 ICs and features an intelligent LCD display. The original L/C Meter had to be manually calibrated, while the new unit is self-calibrating. Best of all, the new L/C Meter is significantly less expensive than the original.  $\Omega$

Which is solved for  $C_x$ , with the equation for  $f_1$ , to produce:

$$C_x = \left[ \frac{f_1^2}{f_2^2} - 1 \right] C_1$$

### Stray inductance and capacitance

The circuit traces on the printed-circuit board, the switches, and the test leads all contribute a small amount of stray inductance ( $L_s$ ) and capacitance ( $C_s$ ). These stray values add to the values of  $L_1$  or  $C_1$  when the  $L_x$  or  $C_x$  switches are pressed, slightly affecting the frequency of  $f_1$ . The unit is zeroed by pressing the ZERO switch, which causes the unit to re-measure  $f_1$  with the stray values in the circuit.

To zero  $L_s$  the operator must short circuit the test leads,

press  $L_x$  and then press the ZERO button. Similarly, for capacitors, the operator open circuits the test leads, presses  $C_x$  and then presses ZERO.

This zero operation is good until the  $L_x$  or  $C_x$  switch is turned off. If the  $L_x$  or  $C_x$  switch is again turned on the unit must be re-zeroed.

### Floating-point math

From all of the above equations it would seem that there is some relatively high-powered math involved and there is. The lower half of program memory in the microcontroller contains a complete 32-bit floating-point math package. The math package includes ADD, SUBTRACT, MULTIPLY and DIVIDE instructions. It also contains conversions from integer to floating-point, float-

ing-point to integer and integer to binary-coded decimal (BCD).

The computer measures frequency by counting the number of oscillator cycles for a period of 0.2 seconds. The result is an integer. This number is converted to floating-point and all calculations are done in floating-point. When the values of  $L_x$  or  $C_x$  are finally computed, the answer is converted to an integer and then to BCD for display.

The upper half of the microcontroller's program memory contains the functional software which is described in Listing 1 by a pseudo BASIC-like, high-level language.

### Construction

The L/C meter is indeed simple and there is no particular order of assembly. Refer to Fig. 3, the parts-placement diagram. Note that there is only a  $\frac{3}{8}$ -inch space under the display when it's mounted. Leave enough lead length on the taller parts so you can tip them at an angle to reduce their height. Figure 4 is a photograph of the board under the display. Note how the crystal and voltage regulator are installed at an angle.

Start assembly with the resistors. Then solder in the sockets for the IC's, the capacitors, and then the switches. The switch terminals should just barely stick through the printed-circuit board in order for the shafts to line up with the holes in the case. Be careful not to install the switches upside-down. Remove the little tin rivet from under the brass leaf of the ZERO switch only. This converts it from an alternate-action switch to a momentary-contact switch (see Fig. 5.).

Solder P1, the male, square-post header, at the top of the PC board. Install the contrast control, R6, on the back of the printed-circuit board otherwise you will not be able to adjust it with the display installed. Install the two  $\frac{3}{4}$ -inch spacers for the test jacks as shown in Fig. 5. This should complete printed-circuit board assembly. Solder J1 to the display unit. A single-sided printed-circuit board is used so don't forget the one

jumper wire needed as indicated on the parts layout. Decide which type of capacitor display you prefer. If you prefer to indicate nanofarads, solder jumper wire JU1 as indicated on the parts layout.

Pass the leads from the battery clip through one of the slots in the battery box of the case and solder them to the appropriate pads of the printed-circuit board. Plug in the display and turn on the unit. If you don't see anything on the display, don't panic, try adjusting R6, the contrast control. The unit will display WAIT for 10 seconds followed by CALIBRATING for two seconds followed by READY. If it does, you're up and running. Adjust the contrast control so the background is just barely visible. Install the printed-circuit board in the bottom of the case using three No. 4 sheet metal screws. Install the top cover of the case and install the binding posts as shown in Fig 5. Test leads should not exceed 4 inches in length with a banana plug at one end and alligator clip at the other.

If your finished unit doesn't work, remove the printed-circuit board and carefully inspect to see you have soldered everything that should be soldered, and that you have not created any inadvertent solder bridges. It is very unlikely you will have any problems; however, if you purchased your kit from the source in the parts list they will try to fix it free except for a

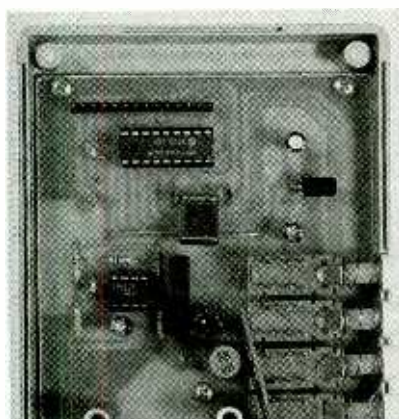

**FIG. 4—THE AREA UNDER THE DISPLAY has a maximum clearance of  $\frac{3}{8}$  inch. Note how the crystal and voltage regulator are tilted to decrease their heights.**

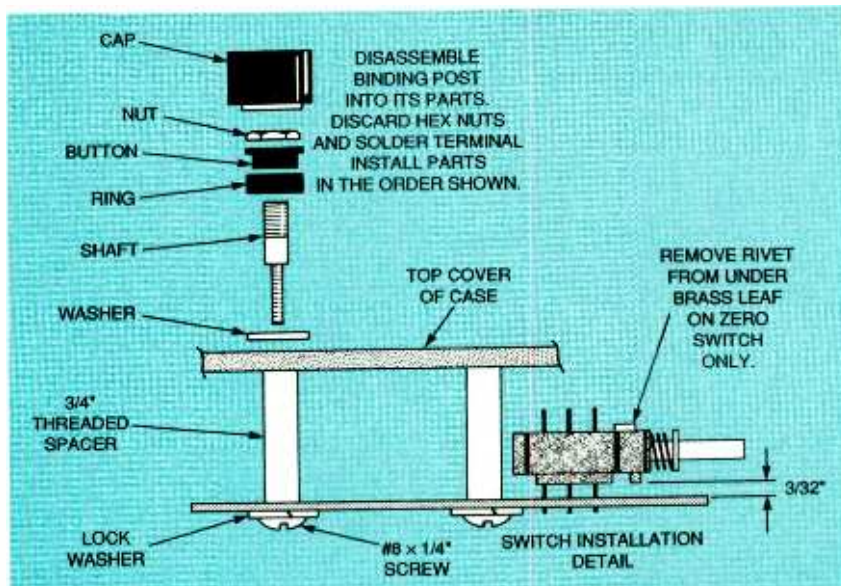

**FIG. 5—MECHANICAL DETAILS. Remove the rivet from the Zero switch to convert it to a momentary-contact switch.**

\$4.00 return postage and handling fee.

For those who wish to make their own printed-circuit board a full size PC-board foil pattern is provided. The switches called out in the parts list should fit without problem. When the original L/C Meter was designed, a large volume of surplus switches was obtained. These are supplied with the new L/C meter kits from the source listed at the end of the Parts List. For those with the capability to program their own PIC16C61 the code can be downloaded from the Electronics Now BBS (516-293-2283 N81). Look for LCM.ZIP. The code can also be purchased from the source listed in the parts list and includes a free copy of MPASM, the PIC assembler, and MPSIM, the PIC simulator.

### Operation

The typical stray inductance is .04 to .06  $\mu\text{H}$  and the typical stray capacitance is 5 to 7 pF. When measuring inductors less than 5  $\mu\text{H}$  or capacitances less than 50 pF, it is advisable to zero the unit first. For larger values, the strays are insignificant to the result. It is difficult to retain a reading of 0.000 pF because of the extreme sensitivity of the meter. Your body capacitance influences the reading. Try zeroing the capacitance and then

move your hands around the test leads without touching them. You will find you can adjust the reading a few hundredths of a picofarad.

To measure inductance, place the unknown across the test leads and depress  $L_x$ . The inductor must have DC continuity, or the unit will display NOT AN L. To measure capacitance place the unknown across the test leads and press  $C_x$ . If the unknown is out of range the unit may break into spurious oscillation and display random or rapidly changing values.

The oscillator tends to drift a few hertz during the first few minutes of operation. When measuring very small values the unit should be allowed to warm up for about five minutes and then re-calibrated and zeroed.

### Accuracy and resolution

The L/C meter accuracy is specified at 3% of reading. This is vastly superior to units specified as percent of full scale. For example a unit on a 1-mH range, specified at 1% of full scale, would have a maximum error of 10  $\mu\text{H}$  which could be as much as a 100% error when measuring a 10  $\mu\text{H}$  inductor. Our L/C meter would have a maximum error of 3% for the 10  $\mu\text{H}$  inductor.

The author measured about  
*Continued on page 88*

# VCR Cross Reference

**NOW Find the right Part  
for your VCR**

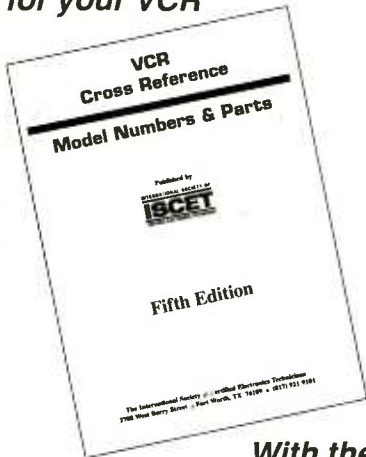

With the

## ISCET VCR CROSS REFERENCE

This 119-page reference contains both model and part-number cross-references updated to include 1994 units.

VCR's are made in a few factories from which hundreds of different brand names and model numbers identify cosmetically-changed identical and near-identical manufactured units. Interchangeable parts are very common. An exact replacement part may be available only a few minutes away from you even though the manufacturer supplier is out-of-stock. You may be able to cannibalize scrap units at no cost!

The ISCET VCR Cross Reference is pre-punched for standard loose-leaf binding. . . \$38.00 plus \$3.00 for shipping for each Reference.

**Claggg Inc.  
VCR CROSS REFERENCE OFFER  
P.O. Box 4099  
Farmingdale, New York 11735-0793**

Name \_\_\_\_\_

Business \_\_\_\_\_

Address \_\_\_\_\_

City \_\_\_\_\_

State \_\_\_\_\_ Zip \_\_\_\_\_

Phone \_\_\_\_\_

Enclose \$38.00 for the Fifth Edition of the ISCET VCR Cross Reference and \$3.00 for shipping for each Reference.

The total amount of my order is \$ \_\_\_\_\_

Check enclosed—do not send cash.

or please charge my credit card.

Visa  MasterCard Exp. Date \_\_\_\_/\_\_\_\_/\_\_\_\_

Card No. \_\_\_\_\_

Signature \_\_\_\_\_

New York State residents must add applicable local sales tax to total. US funds only. Use US bank check or International Money Order. CB02

## WHAT'S NEWS

*continued from page 12*

and Science within the European Strategic Program for Research in Information Technology (ESPRIT) of the European Union.

## 4× digital multilevel storage demonstrated

Information Storage Devices, Inc. (ISD), of San Jose, California, has successfully demonstrated 4× nonvolatile digital storage using a proprietary and patented multilevel storage technology. While traditional digital memory can store only one bit per transistor cell, with ISD's technology it is possible to store four bits of digital data per single memory cell. Such an advancement could lead to substantial cost savings, because 75% fewer memory cells would be required to store a given amount of information. The multilevel technology could play a major role in products for which size, power consumption, and cost are important—for instance, cellular phones, PDAs, fax machines, printers, solid-state film, pagers, and PCMCIA cards.

"The efficiency and cost implications of this technology are significant," said David Angel, ISD's president and CEO. "This development potentially opens up new markets and lower cost points than we previously thought possible."

ISD is contemplating the manufacture of a stand-alone family of 4× nonvolatile digital data storage chips, and is also discussing joint technology and product development with potential partners. The new technology would require no changes to ISD's current manufacturing processes.

## TTL-compatible LMOS logic

Toshiba America Electronic Components, Inc. (TAEC) has introduced a series of LMOS logic devices that is fully compatible with TTL logic output signals and can be used as

a direct interface between a 3-volt to a 5-volt system for mixed power supply logic.

The new devices are offered in small packaging for ease of placement and flexibility of design with PC-board layouts. The super mini 5-pin (SMV), which, at 2.8×2.9mm, occupies 75% less mounting area than an SSOP package. The ultra mini 5-pin (USV), which measures 2.0×2.1 mm, occupies 87% less area.



THE MOVEMENTS OF THE STM TIP are defined by simple mouse clicks on the screen displaying the STM image of the playground. The ring (lower left) marks the starting point of the STM tip; the destination of the pushing process is marked by the cursor arrow.

"The new devices address the needs for a high-speed, low-power-dissipation chip in a small surface-mount package required by portable applications such as notebook computers," said David Lanthier, senior product marketing manager for Toshiba. "TTL LMOS has a typical propagation delay time of 10 nanoseconds and an input leakage current of 1.0 microamperes at 25°C. These features give designers the ability to save on component board space."

Other applications include handheld, portable, and consumer electronics such as cellular phones, PCs, pagers, LAN networks, disk drives, PC peripherals, and PCN systems. **EN**

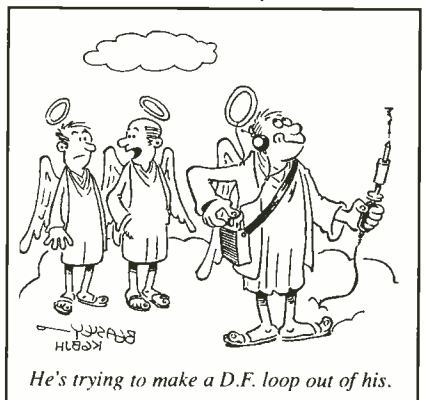

## ATV DOWNCONVERTER

continued from page 38

The gain for the overall circuit can be adjusted by changing the resistive value for R11 (see Table 1).

The IF amplifier directly feeds a 50 to 75-ohm load. Maximum downconverter IF output is around -2 dBm for 1 dB compression. This is 150 to 200 millivolts into a load of 50 to 75 ohms. Capacitor C18 and R13 provide decoupling of the IF circuits from the regulated 8-volt bus.

The local oscillator output signal is generated by Q5 in a typical Colpitts oscillator circuit. Bias for Q5 is provided by R17 through R21. Resistor R21 and surface-mount bypass capacitors C24 and C25 decouple the local oscillator frequency from the regulated 8-volt DC bus. The resonant circuit for the local oscillator is formed by C21, the internal base-emitter capacitance of Q5, and emitter-to-ground capacitance, strip-line Z6, trimmer capacitor C22, and varactor diode D1 in parallel with C23. (Capacitor C23 is not used in 1300 MHz version.) The capacitance of varactor D1 is varied by a voltage applied to it via R22 that ranges from 1 to 8-volts DC.

The varactor D1 provides fine tuning of the local oscillator frequency because the setting of trimmer C22 has the major effect on oscillator frequency. Trimmer C22 will change the oscillator frequency by several hundred MHz. When set correctly, C22 sets the local oscillator frequency so that D1 can tune the circuit over the desired range. This will be a bandwidth of about 30 MHz for the 900 MHz downconverter, and 60 MHz for the 1300-MHz version.

Voltage for D1 is fed through isolating resistor R22 from either of two sources. The first source is the on-board tuning potentiometer R24, whose wiper provides 1 to 8 volts DC. Resistor R25, connected to the ground side of potentiometer R24, sets the low-voltage limit to about 1 volt. Diode D2 acts as

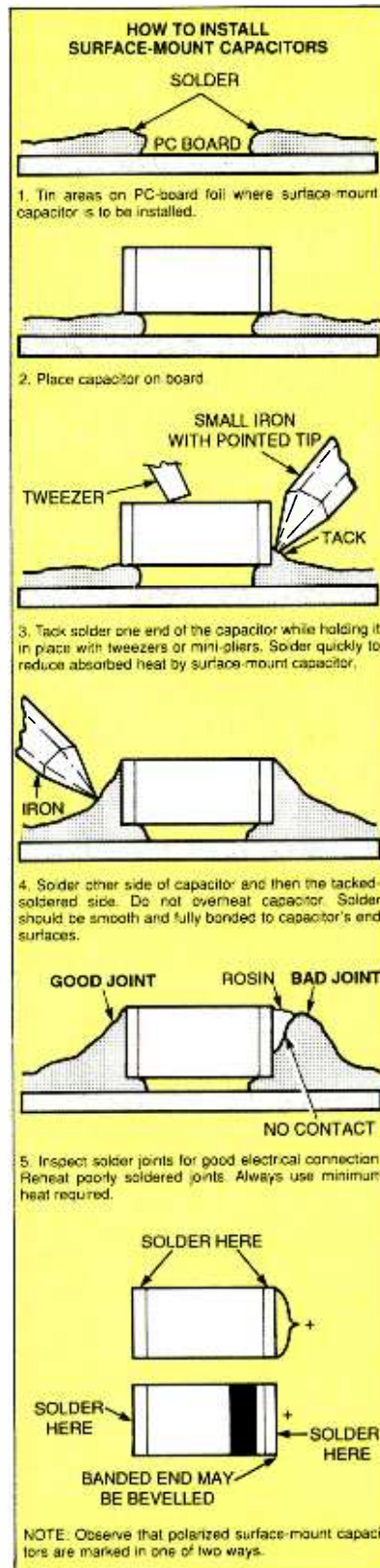

half of a logical OR gate, and R23 and C26 provide a pull-down to ground and RF bypassing for the varactor tuning voltage. The second source is a tuning volt-

age derived from a remote-tuning setup.

### Remote tuning

Remote tuning is an important feature of the downconverter because it allows the unit to be mounted directly at the antenna feed point, thus eliminating a coaxial feedline for 900-MHz signals. Feedlines have high losses at this frequency unless they are special, expensive types. Even then, losses are still high for long cable runs. For example, a good quality, expensive (\$60 to \$80 per 100 feet) coax feed-line such as 9913 has a loss of 5-dB per 100 feet of cable at 1000 MHz. The output of the downconverter can be fed via an inexpensive coaxial cable (such as the RG59 or RG66), which has an attenuation of about 2 dB per 100 feet at the output frequency and costs about \$15 per 100 feet.

A DC Block Unit (see Fig. 3) allows a variable tuning voltage to be added into the IF coaxial feed-line to power and tune the downconverter. This voltage should vary from 10 to 20 volts DC to properly remote tune the downconverter. Capacitor C19 (Fig. 2) blocks this DC but passes the IF signal from Q4. Inductor L3 passes DC (only 10-ohms DC resistance) but blocks the IF signal because it has a very high impedance at 60 MHz. The input of 10 to 20-volts DC is passed to voltage regulator IC1 via blocking diode D7 (Fig. 2). Voltage regulator IC1 supplies +8-volts DC to the downconverter circuitry, insensitive to the 10 to 20-volt variation of the input DC voltage.

The 10 to 20-volts DC input is also supplied to Zener diode D6 and diode D5, dropping 9 volts across these diodes, resulting in 1 to 11-volts DC across pull-down resistor R27. Resistor R6 and clamp diode D4 limit the voltage at the input of D3 to 1 to 9 volts. This results in about 0.3 to 8.3 volts DC across R23 and C26. This voltage is fed to varactor D1 via R22 for tuning. As the DC voltage on the IF cable varies from 10 to 20 volts, the converter is both powered and tuned over its frequency range. If oper-

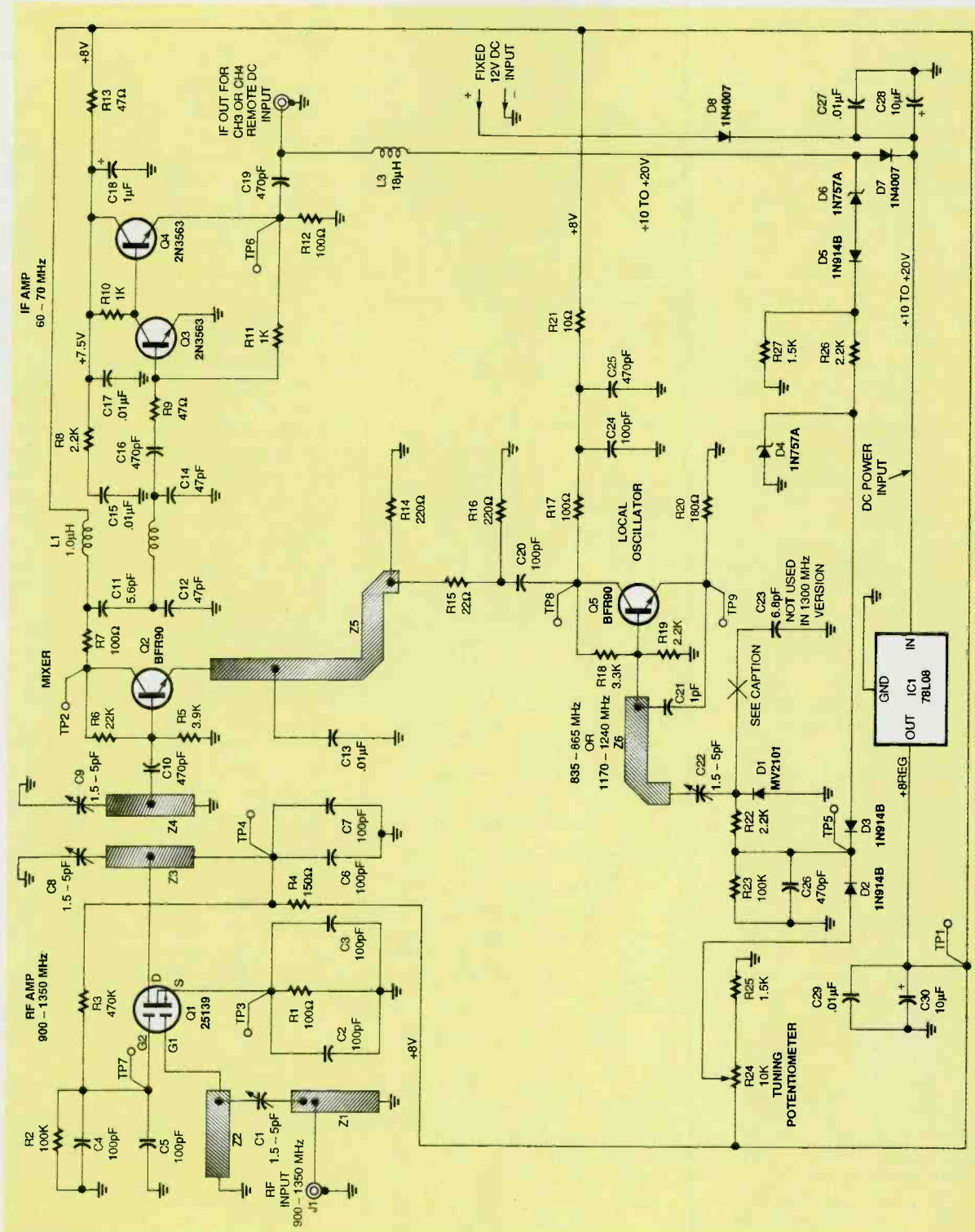

FIG. 2—SCHEMATIC DIAGRAM for the downconverter covers both the 900-MHz and 1300-MHz versions. Aside from slight foil modifications, the only difference is the elimination of C29 in the 1300-MHz version.

ation from a fixed DC power supply (11 to 15 V) is desired, the converter is powered with 12-volts DC via the DC input and blocking diode D8. In this case, tuning is done with the on-board tuning potentiometer, R24, and the DC Block unit is not needed.

When remote tuning is used, tuning potentiometer R24 must be set at its extreme counterclockwise position to set the voltage at the wiper to its lowest DC potential. All or part of the downconverter tuning range won't be obtained with R24 in any other position.

**Clean power supply**

Any hum or noise on the tuning voltage from an external power supply will modulate the local-oscillator frequency, thereby frequency modulating the IF signal. This effect is most degrading for the 1300-MHz model, where the tuning sen-



TABLE 1—TROUBLESHOOTING VOLTAGES AT TEST POINTS

Test Point Location	Volts DC	Localized Trouble Area
Junction of D8, IC2	+11.4	D8
Junction of IC1, C30 (TP1)	+7.6 to 8.4	IC1
Junction of R4, C6, C7, Z2 (TP4)	+6.2 to +7.2	Q1, R4, C6, C7
Junction of R1, C2, C3 (TP3)	(TP3)	+0.5 to +1.2 Q1, R1, C2, C3
Junction of R2, R3, C3, C4 (TP7)	+1.0 to +1.4	Q1, R2, R3, C4, C5
Collector Q2 (TP2)	+5.5 to 7.2	Q2, R5, R6, R7, R8, R13, R14, R15, R16, L1, C11, C15, C17, C18
Junction of D2, D3, C26 (TP5)	0.5 to >+7.0 as R24 is rotated	D1, R24, R25, D2, D3, R23, R22
Collector Q5 (TP8)	+6.5 to +7.2	R21, M C24, C25, Q5, C20, R18, R19, R20
Emitter Q4	+0.8 to +1.0	Q3, R10, R11, R12, C16, C19
Base Q4	0.7 volts more than base of Q3	Q3, R10, R11, R12, C16, C19

\*Check all transistors and IC's for correct installation. Check diodes and electrolytic capacitors for correct polarized installation.

sitivity of the local oscillator is 10 MHz per volt of tuning voltage. Just 1 mV of hum will result in 10 kHz of frequency deviation. For FMTV use, this will be noticeable as video hum bars in the received picture. AM signals will be less susceptible to hum and noise from the power supply.

This power supply defect should not be tolerated because it is easy to build a clean external power supply from inexpensive readily available voltage regulator ICs.

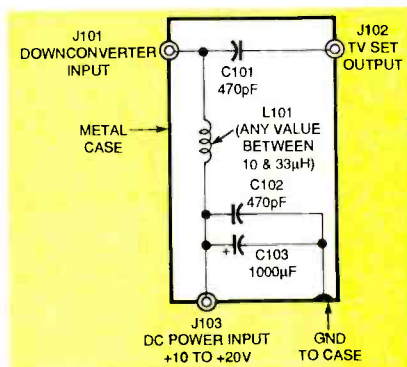

FIG. 3—DC BLOCK UNIT is required at the TV receiver or monitor site when remote tuning the downconverter.

### Pre-construction details

Do not substitute parts specified in the Parts List or change the PC-board layout should you etch a PC board from the patterns shown.

Use good lighting while assembling parts on both sides of the 2.5 × 4-inch PC board. A magnifier lens is necessary because the parts are too small to check for markings and solder joints are too minuscule to inspect with the naked eye.

All trimmer capacitors and grounded leads of resistors

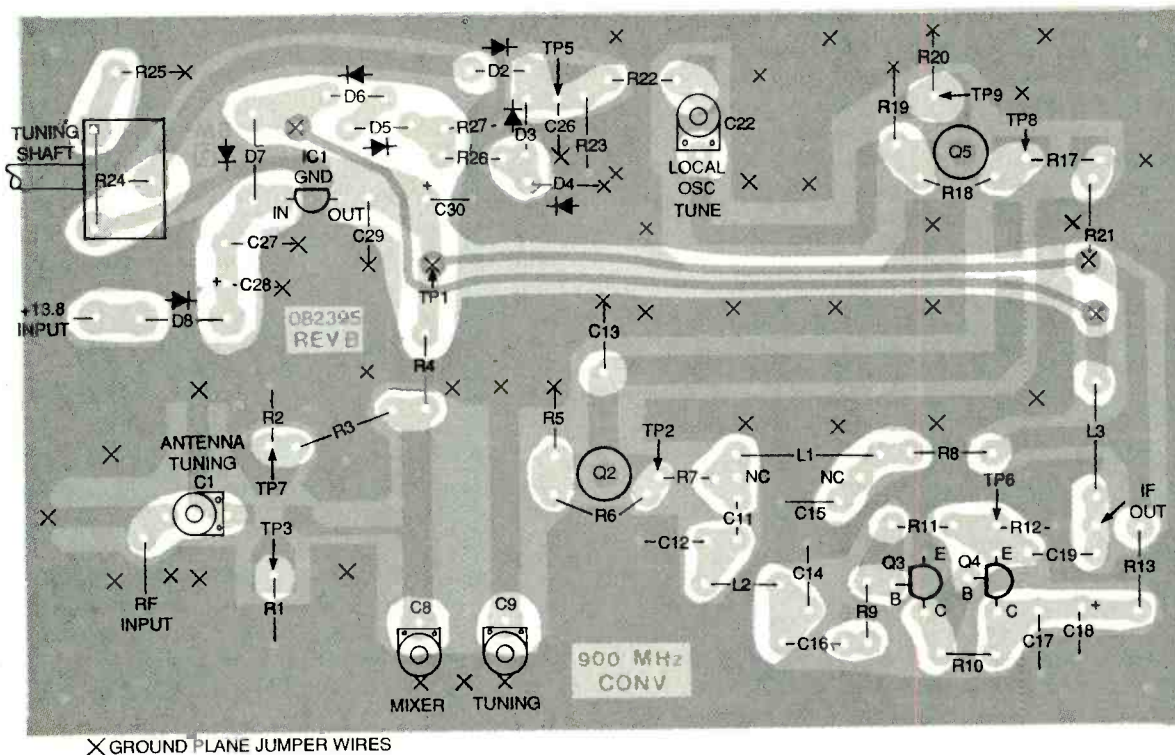

X GROUND PLANE JUMPER WIRES

FIG. 4—TOP SIDE OF PC BOARD for the 900-MHz downconverter is shown with parts locations identified. Be sure to install all ground jumpers where indicated and solder to both sides of the PC board.

## FOIL DIAGRAMS FOR THE DOWNCONVERTER 900-MHz AND 1300-MHz MODELS

While it is possible to design the same printed-circuit board foil pattern for both Downconverter models (since the frequencies differ by 350 MHz), compromises are necessary in the RF microstrip elements which would result in performance sacrifice in RF gain and tuning rate. Therefore, individual foil patterns were designed for each model. The 900-MHz model can be re-tuned to cover up to about 1100 MHz, and the 1300-MHz model will cover about 1150 to 1450-MHz (in 60-MHz segments) for other applications, with almost the same performance. The IF output frequency can be changed to anywhere between 40 and 100 MHz by changing one component and shifting the local oscillator frequency as required. The foil patterns provided are actual size and can be copied.

Starting in the upper-left corner and proceeding clockwise, the foil patterns are: 900-MHz top, 1300-MHz top, 1300-MHz bottom, and 900-MHz bottom. The PC boards are all the same size—4 X 2.5 inches.

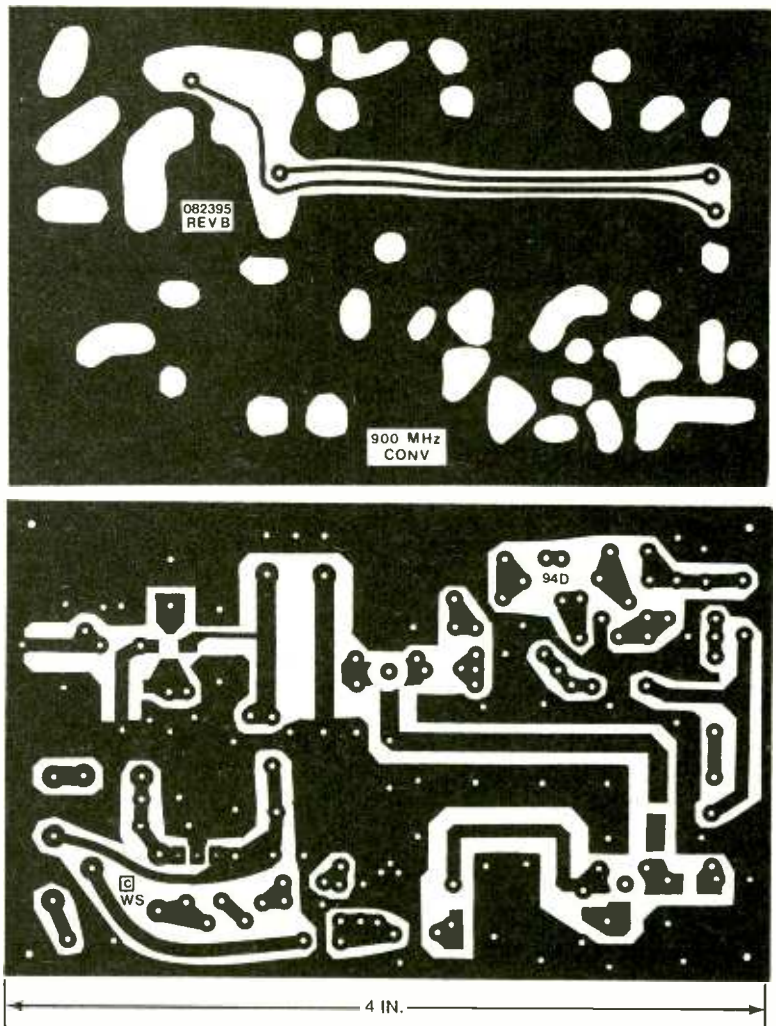

must be soldered on both sides of the foils on the PC board. This is good RF grounding practice. Also, there are many ground-plane jumpers (approximately 3 dozen) that must be soldered in place, because the commercially available PC boards are not plated through, and plated-through PC boards cannot be made at home.

Do not solder any parts to the PC board until as many components as possible are inserted. Coils L1 through L3 are installed after all other components are inserted. Mount all parts tight and close to the board. Projects in the microwave frequency region require *zero-lead lengths* for parts in the RF circuit sections.

### Start construction

Begin construction by inserting all trimmer capacitors in

### PARTS LIST

**All resistors are 1/8-watt, 5% unless otherwise specified**

R1, R7, R12, R17—100 ohms  
R2, R23—100,000 ohms  
R3—470,000 ohms  
R4—150 ohms  
R5—3,900 ohms  
R6—22,000 ohms  
R8, R19, R22, R26—2,200 ohms  
R9, R13—47 ohms  
R10, R11—1000 ohms  
R14, R16—220 ohms, surface-mount  
R15—2 ohms, surface-mount  
R18—3,300 ohms  
R20—180 ohms  
R21—10 ohms  
R24—10,000-ohms potentiometer  
R25, R27—1,500 ohms

#### Capacitors

C1, C8, C9, C22—1.5-5 pF trimmer, PC mount

C2—C7, C20, C24—100 pF, surface-mount

C10, C25—470 pF, surface-mount

C11—5.6 pF, NPO

C12, C14—47 pF, NPO

C13, C15, C17, C27, C29—0.01  $\mu$ F, GMV disk, 50-volt

C16, C19, C26—470 pF, GMV disk, 50-volts

C18—1.0  $\mu$ F, 35-volt electrolytic

C21—1 pF, surface-mount

\*C23—6.8 pF, surface-mount

C28, C30—10  $\mu$ F, 25-volt, electrolytic

\*Used in 900 MHz downconverter only

#### Semiconductors

D1—MMBV2101T1 (Motorola) varactor, 6.8 pF at 4 volts, surface-mount

D2, D3, D5—1N914B, fast-switching diode

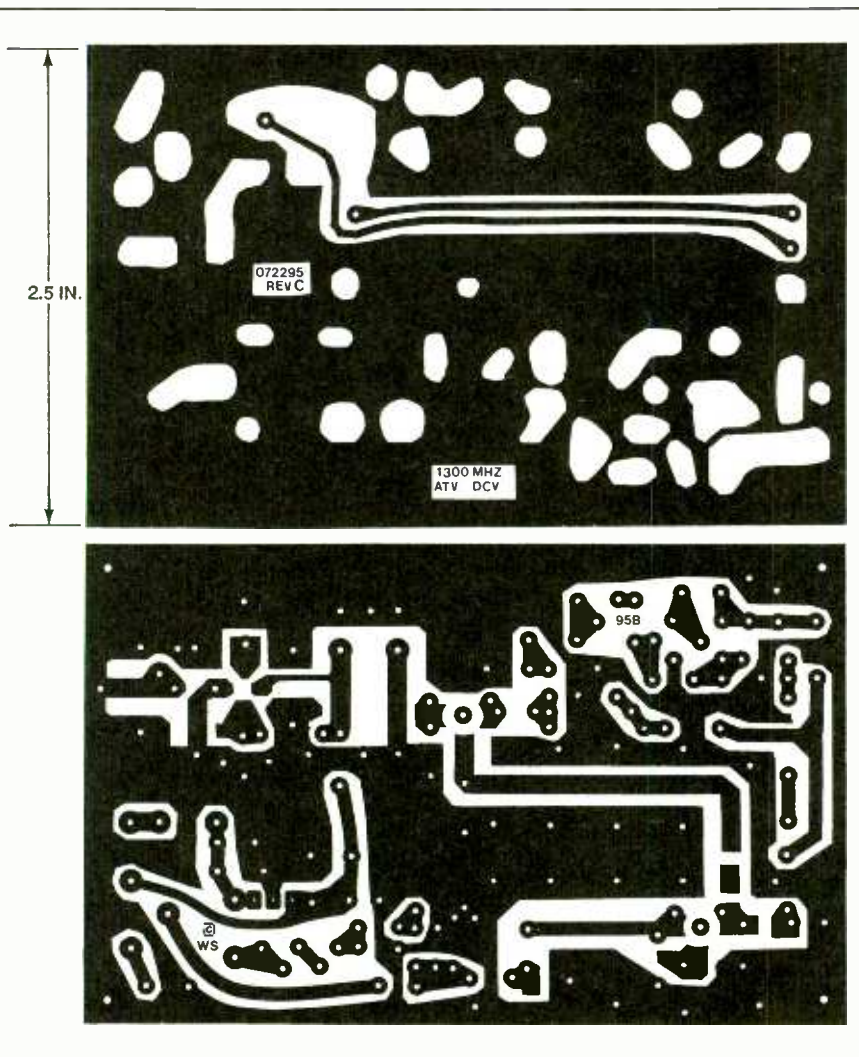

the PC board. See Fig. 4. Solder trimmer rotor terminals to the top side of the PC board. Be careful not to melt the plastic. Do not solder the bottom foil at this time.

Mount all 1/8-watt resistors. Only solder the top of the PC board where resistor lead passes through the ground foil. Solder as many as you can. Do not solder the bottom foil yet. Surface-mount resistors will be installed later. Install tuning potentiometer R24. Leave the thumbwheel of R24 in the center-rotation position.

Install the fixed capacitors. If any come with pre-formed leads, straighten the leads with pliers so the capacitor can fit as close to PC board as possible. Pull the leads through board so capacitor bodies are tight to PC board. Watch polarity of all electrolytic capacitors. Confirm that the capacitor values are correct prior to soldering them in place.

Do not install any of the surface-mount components yet. Install all transistors and diodes, except Q1 (25139) which will be installed later. See Figs. 4 and 5. Check polarized parts for correct orientation. All TO-92 transistors should be 1/8 inch from

- D4, D6—1N757A, 9.1-V, 0.5-watt, Zener diode
- D7, D8—1N4007, 1000-V, 2.5 A, rectifier,
- Q1—NE25139 (California Eastern Labs.) low-noise, dual-gate RF-amplifier
- Q2, Q5—BFR90, npn, low-noise, UHF amplifier, MESFET
- Q3, Q4—2N3563, npn, RF/IF/Video bipolar
- †C1—78L08, positive voltage regulator

**Coils and Chokes**

- L1—RF choke, 1 μH, ± 5%
- L2—Fabricated coil (see text)
- L3—RF choke, 18 μH with less than 10-ohms resistance

**Miscellaneous**

- J1, J2—See text
- 1—Plastic shaft extension for R24
- 1—Length of #22 enameled, solid copper wire

- 1—Machine screw, #8-32, binding head
- 1—PC board for 900-MHz or 1300-MHz downconverter

**DC BLOCK UNIT (OPTIONAL)**

- C101, C102—470 pF, disc ceramic, 50-volts
- C103—1000 μF, 25-volts, electrolytic
- J101, J102—Type F connectors, female, chassis mount
- J103—DC power connector that can be shielded, 2.5 mm or RCA phono, female chassis mount
- L101—Any value from 10 to 33 μH, less than 10-ohms DC resistance
- 1—Metal enclosure, RF tight

A complete parts kit for the 900-MHz or 1300-MHz downconverter, consisting of the PC board and all parts that mount on it, is available from: North Country Radio, PO Box

53, Wykagyl Station, New Rochelle, NY 10804. The 900-MHz model sells for \$39.00, 1300-MHz sells for \$41.00. Both models: \$76.50 (must be ordered at same time). Please add \$4.50 for postage and handling for one unit or \$5.50 for both units. New York residents must include local NY sales tax. Be sure to specify which model (900 or 1300 MHz) you are ordering. Parts for optional DC Block Unit are not included in this kit.

A catalog containing information on transmitters, downconverters, video cameras and lenses, and a number of other kits and electronic projects is available from the above address. Please send SASE (75-cents postage) and \$1.00 to cover handling and mailing (refundable with order).

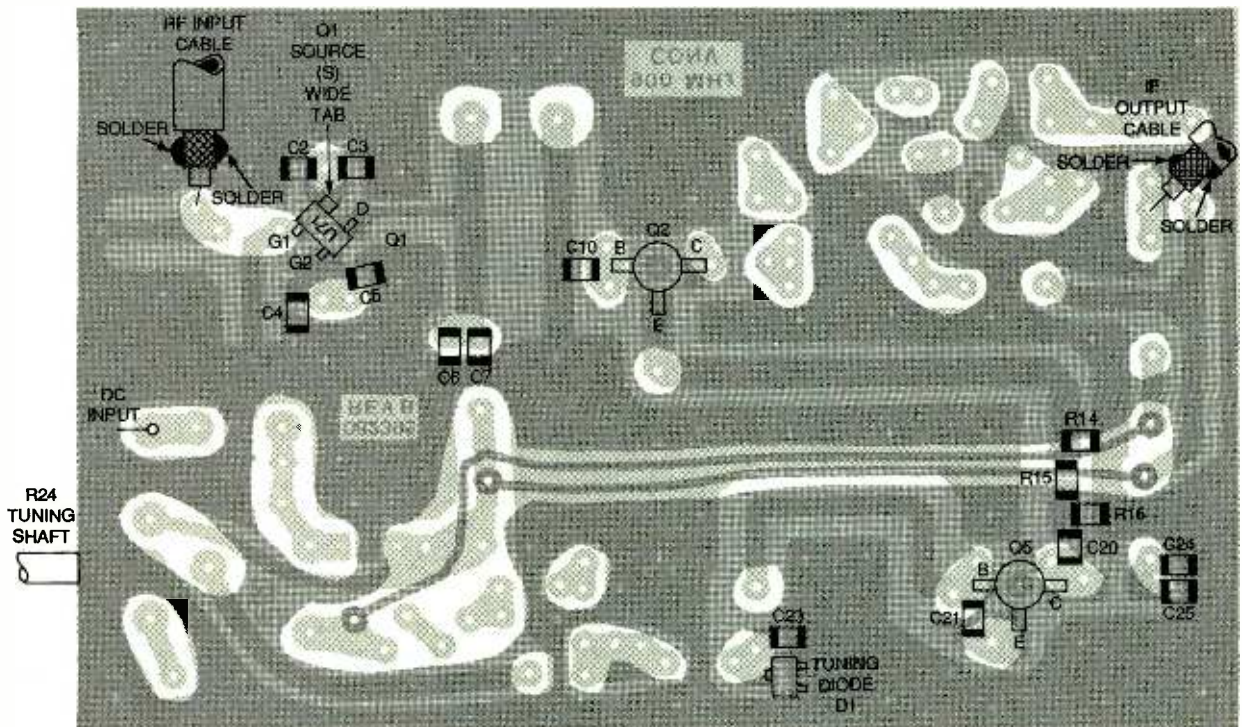
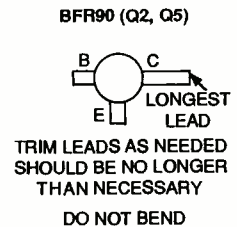
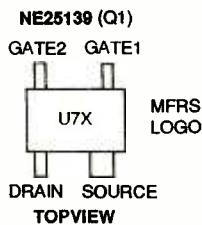

FIG. 5—BOTTOM SIDE OF PC BOARD for the 900-MHz downconverter is shown with parts locations identified. Cable lengths should be just long enough to provide suitable length when PC board is installed in a metal case.

the surface of board. Solder the emitter lead of Q3 to the top of the PC board where it passes through ground foil. Install voltage regulator IC1 and check its lead orientation. The flat end should face the edge of the PC board.

Check all work done so far for accuracy and orientation of components. Trim all component leads close to the PC board. Solder all bottom foil connections. (Do not plug any unused holes with solder.) Carefully fabricate L2 (see Fig. 6) and install in the PC board. Use an 8-32 screw as a tool to hold L2 during installation. After installing L2, remove screw by unthreading it from the coil. Coat L2 with clear lacquer, Duco cement, or clear nail polish.

Use left-over lead clippings or bare, solid, tinned wire to install ground plane jumpers in

all open positions (see Fig. 4)—*this is very important*. Install a 1-inch length of bare tinned wire in +12v connecting hole near D8 to serve as a terminal. Place a piece of sleeving over it to avoid short circuits and make a small hook at the wire's end.

Install all surface-mount capacitors, as shown in Fig. 5, on the *bottom* foil of the PC board. Refer to detailed surface-mount instructions in sidebar *How to Install Surface-Mount Capacitors*. After installing all surface-mount capacitors, avoid flexing the PC board, which might crack the surface-mount capacitors.

Install the surface-mount resistors R14, 15, and 16 the same way as surface-mount capacitors (see Fig. 5). Resistors R14 and R16 are marked 221 (220 ohms) and R15 is marked 220

(22 ohms). Install the resistors with the marked side facing up from PC board so the markings are seen. Check the resistive values with an ohmmeter or DVM before installation.

Install Q1 as shown in Fig. 5. The thicker lead is the source (S) lead. Handle Q1 carefully; it is sensitive to electrostatic discharge (ESD). Check the orientation of Q1's leads before soldering in place. Then, install D1. The side of D1 with two leads is the ground side.

### Tune-up and checkout procedures

The downconverter is aligned by peaking for maximum received signal. There is no tricky alignment procedure or specialized RF test gear necessary for good results and performance from the downconverter.

The successful tune-up of the downconverter requires either a known signal in the 900 or 1300 MHz band to act as a reference

and tune-up aid, or access to a frequency counter and a signal generator covering this range. A sweep generator is excellent if you can obtain the use of one. If you have an ATV transmitter, it can be used as a signal source—but remember to use a dummy antenna and keep the transmitter at some distance to prevent overloading the downconverter. You will need a suitable TV receiver or monitor tuned to either VHF channel 3 or 4, (an old B/W portable TV will do), a variable power supply supplying 10 to 20-volts DC at 40 milliamperes or more (preferably one with a built-in voltage and current metering), a DMM, and clip leads and cables as needed. If you cannot obtain these items, find someone to help you. A frequency counter that is reliable to at least 100 MHz higher than the downconverter receiving frequency is a great help in setting up the local oscillator and finding out where you are during tune-up.

First, carefully check your work for accuracy, component placement, and correct orientation, and poor solder connections. Make sure that surface-mount capacitors are correctly installed—a malfunction can destroy the gain of a stage. Also check for inadvertent solder bridges. When you are sure everything is OK, connect a DC source to the 12-volt input (D8 and ground). Ground is negative. No damage will occur should the power supply be accidentally reversed. Note the current drawn from the power supply. It should be around  $35 \pm 5$  milliamperes. If higher than 40 milliamperes, check for possible short circuits. If lower than 30 mA, something may be open or missing.

### Voltages checks

Refer to schematic diagram (Fig. 2) and parts layout diagrams (Figs. 4 and 5) so that you fully understand the circuit portions that will be tested. Unless specifically stated, the negative meter lead shall be grounded to negative terminal of power supply when making voltage measurements. If volt-

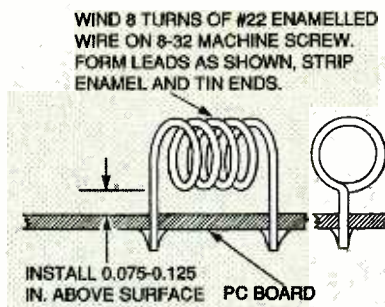

**FIG. 6—COIL L2 FORMING and installation details.** Wind 8 turns on 8-32 machine screw to form coil L2. Do not remove screw until after installation on PC board.

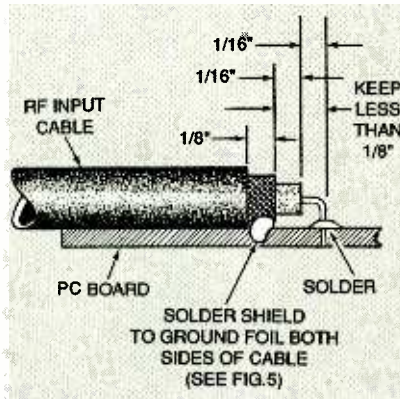

**FIG. 7—INSTALLATION of RF input cable is critical.** Keep recommended dimensions equal to or less than given in diagram, otherwise excessive losses will occur.

age discrepancies are noted, check the components indicated in Table 1 (page 69) for faults. Slight variations outside specified voltage limits specified may be ignored if component checks do not reveal anything wrong. If you experienced some deviation from the voltages measured but were not too far off, the downconverter may be OK, but remember and record these slight voltage deviations should any further problems be encountered. If trouble is experienced at a later step with that particular circuit, further investigation may be needed. Remember that the 8-volt on-board regulator has a 5% tolerance and this will affect all other readings. Also, your DMM could be a few percent in error as well.

1. Set the thumbwheel of R24 at its approximate center position, and set C22 so its plates are about  $\frac{1}{4}$  meshed. Now measure the voltage at the base of

Q2. Using a non metallic tool, slowly rotate trimmer C22. There should be some perceptible voltage change at base of Q2 as C22 is rotated from minimum to maximum and back. Touching a metallic screwdriver blade to the stripline Z6 should also produce some change in this reading if Q5 is oscillating. A change of 0.01 volt or more is about what you will see if all is OK. This confirms that the local oscillator circuit is oscillating and that the mixer is getting a RF signal from the local oscillator.

2. Check that no part is getting hot.

3. If steps 1 and 2 are successful, connect the positive lead from a variable-voltage supply to junction C19 and L3, and connect the negative lead to ground. Set the wiper of R24 at ground (extreme counterclockwise rotation as viewed from shaft side). Set the power supply to +11 volts. Check for following voltages:

- At TP1 a voltmeter should indicate +7.6 to +8.4-volts DC as measured before in step 1. If not OK, check L3, D7, C27, and C28.

- At TP5 a voltmeter should indicate less than +1.2-volts DC. If not OK, check D6, D5, R27, R26, D4, and D3.

4. Increase the power supply voltage to 19 or 20-volts DC. Repeat step 3. The reading at TP1 should still read the same, however TP5 should be about +9-volts DC. If not, check all components mentioned in step 3. Steps 3 and 4 check out the remote tuning circuitry. If OK, proceed with the alignment in next step.

5. Connect the center conductor of a 75-ohm coaxial cable to the junction of C19 and L3 and the shield braid to ground as shown in Fig. 5. Terminate the end of the cable to J2, a connector suitable for your TV or monitor. (This is generally a type F connector.) Tune the TV to channel 3 or 4—whichever is unused in your area—and set its controls for normal reception. If you have a sensitive RF millivoltmeter, use it as an output indicator instead of a TV

set. The meter is easier to interpret.

Connect a suitable signal source to J1, the downconverter input. Use 50-ohm low-loss cable and keep connections short. Refer to Figs. 5 and 7 for cable installation dimensions that are critical. The signal source can be either a generator or antenna. Preset all trimmer capacitors (there are four) to settings given in Table 2. Make sure to use the correct presets as the presets for 900 and 1300 MHz versions differ. Set the thumb-wheel of R24 to its center position.

6. Connect +12 to +14-volts DC from the power supply to D8, the negative lead connects to foil ground. Keep the bottom of the PC board at least 1/2 inch above any kind of material which may detune the microstrip elements on the bottom of the PC board. Because both conductors and insulators can cause detuning, a set of four 1/2 or 3/4-inch plastic or brass standoffs installed in the four corner holes of the PC board should be used. Use only a non-metallic tuning tool for all adjustments in the following steps.

7. Activate the signal source and slowly rotate C22 until some indication of reception is seen on the monitor or RF voltmeter. Use a fairly strong signal at first. On confirmation of reception, decrease signal until it is just high enough for a reliable indication. As you remove the tuning tool from C22, undoubtedly some detuning will occur. You will have to compensate a little to get the tuning correct when the tool is removed. A frequency counter rated up to

**TABLE 2**  
**TRIMMER CAPACITOR PRESETS**

Trimmer Capacitor	Percent of Mesh
Presets for 900-MHz model	
C1, C8, C9	25%
C22	80%
Presets for 1300-MHz model	
C1, C8, C9	10%
C22	20%

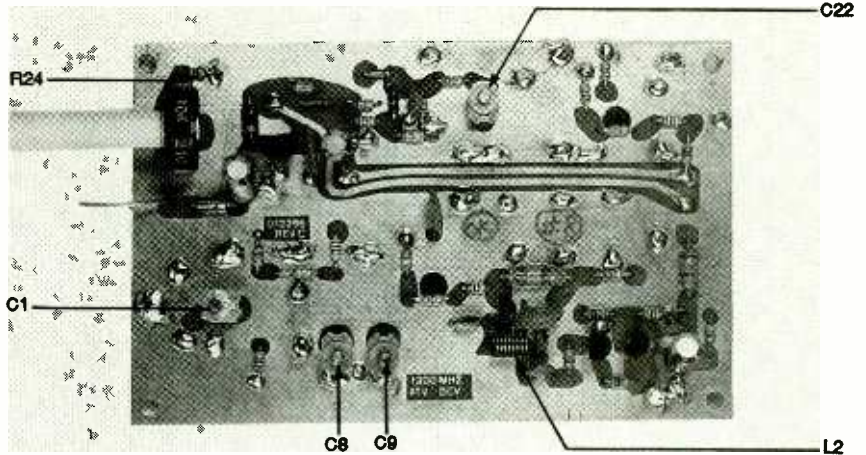

**CLOSE-UP VIEW OF 1300-MHz downconverter board. Short lead lengths and neat construction techniques are a must!**

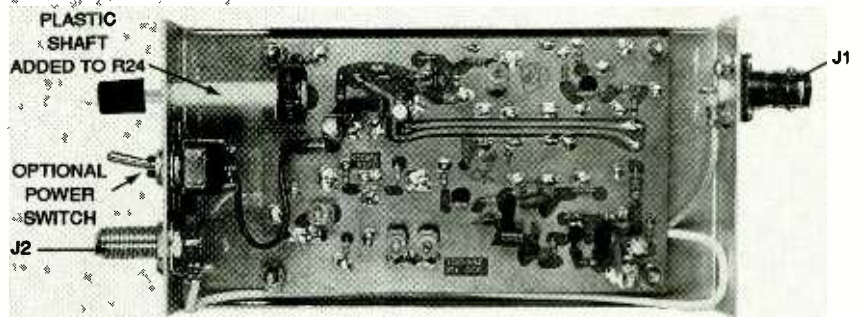

**MOUNT THE DOWNCONVERTER in a metal case for proper shielding. Use connectors to match your equipment.**

1000 to 1500 MHz can indicate frequency shifts.

8. Next, couple the frequency counter to Q3. Stay at least 1/2 inch away from C22 and Q3. Set C22 for  $850 \pm 3$  MHz with R24 at its center position (900 MHz model) or  $1210 \pm 3$  MHz (1300 MHz model). You must have a steady reading, not a wildly jumping one. You may have to experiment with the coupling method, depending on your counter. We found loop coupling a little easier than the factory supplied whip antenna that came with our counter. Do not connect any probes, cables, or wires directly to the oscillator circuit or any of its components. A cable can be connected to the emitter of Q2 through a 220-ohm 1/8 or 1/4-watt resistor for the frequency counter, if desired, but this may detune the oscillator 10 or 20 MHz. However, with certain counters that are low in sensitivity above 800 MHz this may be the only way to get a steady reliable reading.

You can later compensate for this by touching up C22 once you are in the ballpark.

9. Once you obtain a steady reading and you are reasonably sure it is valid, proceed to check the local-oscillator tuning range. Rotate R24 through its entire range. For the 900 MHz model, the local oscillator should cover 840 to 867 MHz (assuming a channel 3 IF) and 1180 to 1240 MHz for the 1300 MHz model. Note that most ATV activity on 900 MHz is between 910 and 923 MHz, and in the case of the 1300 MHz, between 1240 and 1290 MHz (with gaps) so if you cannot quite achieve a 27 MHz range on 900 MHz, this should not be a problem. You can extend the range by replacing C23 on the 900-MHz model with a 5 pF chip NPO and re-tuning C22. The 1300 MHz model has somewhat wider tuning range (typically greater than 70 MHz). It is desirable to keep the tuning range as narrow as possible to improve the tuning

rate and ease of tuning a station. Adjust C22 as necessary to ensure desired coverage. For other IF frequencies, the local oscillator tuning range can be shifted lower (higher IF) or higher (lower IF). Note that the local oscillator must be *below* the signal frequency or else the IF signal will have its spectrum inverted with respect to the input signal spectrum. This will cause difficulties in TV reception in AMTV, and video and sync inversion in FMTV reception, unless the IF is designed for this.

If no frequency counter is available, you will have to depend on the reception of a known signal, or use a calibrated receiver covering the local oscillator range to pick up the local oscillator's signal.

If you don't have a frequency counter, receiver, or analyzer, don't worry. Use a known signal as follows. First set C1, C8, C9 and C22 to the presets shown in Table 2 if you have not yet done so. Set R24 at center of range. Slowly rotate C22 until some indication is seen on the TV or monitor, or other output indicator connected to junction of C19 and L3. Next, confirm that this is due to the signal source by shutting it off. If the indication disappears, this is the signal you want. Keep the signal level as low as possible for best results. If you get no results, make sure the signal has not gone off the air, and that trimmers are preset to correct settings, and the monitor, TV receiver, or indicating device is correctly set up and functioning. The presets are close enough to enable a strong signal to pass through the downconverter and give an indication.

10. Once you have an indication on the screen, peak C1, C8, and C9 for maximum signal as seen on the monitor. You should repeat this step as needed until no further improvement is obtained. Recheck setting of C22 to ensure correct tuning range is obtained. Check your final settings against presets. They should not be very different, as the tuning elements are printed on the PC board and therefore

tuning should be close to presets shown. However, if you are setting up the downconverter for other than the specified frequency ranges, the presets will vary.

11. Your downconverter is now working. Now you can go over the adjustments again to further improve performance. If you can get access to a sweep generator, align the downconverter for a flat response within  $\pm 2$  dB over the selected amateur band. The alignment is simple and straightforward so do not hesitate to experiment. You should be getting about 37 to 43 dB gain out of the downconverter and around 2 to 3 dB noise figure if everything is working properly.

12. The downconverter can be mounted in a shielded box with connectors of your choice. We recommend type N, TNC, SMA, or BNC for the input and an F connector for the output. Be sure to waterproof all connections for mast mountings. It is suggested that the alignment be checked after mounting the PC board in any enclosure since some slight detuning may result.

13. For remote tuning, make sure your variable supply is *clean*. Any noise or hum will cause FM on the local oscillator signal and a noisy received picture. Be sure also to set R24 fully CCW when remote tuning is used, or else the converter tuning range will be restricted or nil.

#### Variable gain

Both models of the downconverters develop 37 to 43-dB power gain from the antenna input to the RF output. This gain may be too much when strong TV signals are received, resulting in overload of the TV set. The unit's gain may be modified by changing R11 from the default value of 1000 ohms to other values as specified in Table 3.

A 1000-ohm potentiometer in place of R11 can be used for providing continuous variable gain. This portion of the circuit operates at the IF frequency, so a potentiometer and wiring tech-

TABLE 3—PRESET GAIN

Desired Gain (dB)	R11 Value (Ohms)
43	2,200
34	470
28	220
25	100

niques suitable at 70 MHz should be used. The IF output should be maintained below 150 millivolts rms in order to prevent overload of the converter. This is a very strong signal to feed into a TV receiver or video monitor.

Resistor R11 values assume a nominal gain of 40 dB. Increasing the gain beyond an extra 3 dB is not recommended. To reduce RF gain for very strong signals, it is recommended that a negative bias voltage supply of 0 to -10 volts be applied to TP7 through a 220,000-ohm resistor. This can be obtained from a potentiometer that is connected across a -10 V DC supply.

The potentiometer functions as an RF gain control in this case. Reverse AGC from the TV receiver used as a monitor could be arranged so as to bias TP7 from +1.5 volts DC at zero signal to -3.0 VOLTS DC on strong signals. Typically 35 to 40 dB RF gain reduction may be obtained using either of these approaches. As TV receivers vary, the individual circuit arrangements for doing this are left to the ingenuity of the builder.

Another gain reduction method is the use of a manually operated switch to ground TP7. This will reduce RF gain approximately 10 dB. This switch can be a simple SPST switch. For greater reduction of gain the switch may be connected to a negative voltage of -1 to -3 V as needed.

The matching ATV transmitter for the downconverter appeared in the May, 1996 issue of *Electronics Now* and corner reflector antenna construction will be covered in a future issue of *Electronics Now*. Refer to the May, 1996 issue for details of the system's overall performance in field trials.  $\Omega$

It started in America!

# The creators are the masters in manufacturing the finest video products...

You probably don't associate VCR's with American technology. Fact is, video recording has its origins in America and it was 3M that brought video recording out of the lab and into your living room. Today, 3M video tape is the choice of all the major networks. No other tape company has ever won an Oscar or an Emmy. 3M Black Watch tape follows in this tradition—service and quality go hand in hand. Here are three Black Watch products you should be using at home!

**Clean up!** With constant playing and using of degrading dry or wet cleaners, the output of your video tapes has slowly diminished to an unacceptable level and the VCR plays as if it has a head cold! The culprit is most likely clogged and dirty video and/or audio heads. The 3M Black Watch™ Head Cleaner Videocassette uses a patented magnetic tape-based cleaning formation to remove head clogging debris. No foreign substances such as cloth, plastics or messy liquids and no harsh abrasive materials are present. The cleaner's usable life is 400 cleanings or more!

It's easy to use. Place the 3M Black Watch™ Head Cleaner Videocassette in the VCR and press the Play button. A pre-recorded message will appear clearly on your screen and an audible tone is heard, telling you that the cleaning process is now completed. No guess work; you never over clean! Priced at \$19.95.

**For the VCR!** Once your VCR's record and playback heads are cured, and the unit plays like new, consider using the finest videocassette you can buy—the 3M Black Watch™ T120 Hi Pro VHS 4410 Videocassette. The 4410 is the highest performing videocassette available today for use with all standard format VHS recording hardware!

Here's what you hear and see....A sharp, clear picture—brightest ever colors—freedom from streaks, flashes and snow—outstanding high-fidelity audio reproduction—optimum camcorder performance—maintains recording integrity. 3M Black Watch™ video tape is 100% laser inspected to guarantee surface smoothness and drop-out free performance. Priced at \$8.00

**You saw it here first!** 3M Black Watch™ 0900 8mm video tape cassette loaded into your Hi Band camcorder delivers the finest picture and sound possible in the 8mm format. Extremely fine particles of pure iron alloyed with nickel and cobalt deliver a video performance exceeding 400 lines of horizontal resolution. You get the advantage of an exceptional video image with superior audio re-



**For the clearest pictures you ever record!**

production. This means your Hi 8 format camcorder will produce the best video and audio definition possible. With the 3M Black Watch™ 8mm cassette, the recording capability and performance of your camcorder will be significantly enhanced. Priced at \$14.95.

**Claggk Inc. — 3M VHS Special Offer**  
P.O. Box 4099,  
Farmingdale,  
New York 11735

Yes, I like your offer and here is my order for 3M Black Watch™ products!

- \_\_\_ 3M Black Watch™ 0900 Hi Band-120 8mm Cassette (\$14.95 each) \$ \_\_\_\_\_
- \_\_\_ 3M Black Watch™ T120 Hi Pro VHS 4410 Videocassette (\$8.00 each) \$ \_\_\_\_\_
- \_\_\_ 3M Black Watch™ Head Cleaner Videocassette (\$19.95 each) \$ \_\_\_\_\_

Shipping and handling per order \$4.00

Total Amount in U.S. Funds only \$ \_\_\_\_\_

New York residents add local sales tax. Canadians add \$6.00 per order. No foreign orders. Do not send cash.

Bill my  VISA  MasterCard  
 Card No. \_\_\_\_\_  
 Expire Date \_\_\_/\_\_\_/\_\_\_  
 Signature \_\_\_\_\_  
 Name (Please print) \_\_\_\_\_  
 Address \_\_\_\_\_  
 City \_\_\_\_\_ State \_\_\_\_\_ ZIP \_\_\_\_\_

## HARDWARE HACKER

continued from page 50

*Synergetics* and not to *Electronics Now* editorial. Snailmail only please.

### New tech lit

From *Fujitsu* a fat new data book about *Wireless Communications and Power Management*. From *Micrel*, a *Designing PCMCIA Power Control* ap manual and data book.

From *Analog Devices*, free design software on the *TMP01 Temperature Controller*. An *Electronic Designer's Guide* is available from *Littelfuse*.

Two economical alternate sources for oscilloscope test probes are *Probe Master* and *Test Probes Inc.*

Low cost bearings are available in the *Nyliner Plus Evaluation Kit* from *Thomson*. Details on a fresh *Gelcast* approach to low cost ceramics (both magnetic and otherwise) are offered from *Oak Ridge National Labs*. Used Santa Claus machines are in stock at *Commonwealth Trading*.

Several freebie samples of useful self-stick *Velcro* products are offered by *Levitt Industrial Textile*.

Power electronic modules suitable for large motor controls and such are offered at bargain prices by *Beyond Electronics*. Free catalogs.

*Talking Electronics* is a brand new international hobby magazine. This one appears to have lots of hands-on and low cost projects.

For all the fundamentals of digital integrated circuits, be sure to check out my *TTL Cookbook* and *CMOS Cookbook*. These are also available as a portion of my *Lancaster Classics Library*. From *Synergetics*. I'm in the process of building up a web page at <http://www.tinaja.com> I am calling it *The Guru's Lair*. It is still under construction, but you are certainly welcome to visit. Eventually, it should hold rich text and fast globally searchable reprints for all of my columns and stories, a technical helpline area, links to other sites, a *Synergetics Consultant's Net* access, plus third party support for the Basic Stamp and similar goodies. My site works best when you have both *Netscape Navigator Gold* and an *Adobe Acrobat Amber* reader. EN



## FLY CONTROLLER

continued from page 40

### PARTS LIST

All resistors are 1/4-watt, 5% units.

R1—560 ohms  
R2—100 ohms  
R3—120 ohms  
R4, R5—100,000 ohms  
R6, R7—330 ohms

#### Capacitors

C1—470  $\mu$ F, 25 volts, electrolytic  
C2—0.004  $\mu$ F, 25 volts, electrolytic  
C3—0.01  $\mu$ F  
C4—40  $\mu$ F, 25 volts, electrolytic  
C5—0.2  $\mu$ F  
C6—0.007  $\mu$ F, 100 volts

#### Semiconductors

D1—1N4002 diode  
IC1—LM317T voltage regulator  
IC2—LM3909 LED flasher  
IC3—NE7555 or NE555 timer  
LED1—Red LED  
Q1—2N2222A switching transistor, NPN

Q2—2N3055 power amplifier, NPN  
Q3—KTN2222 infrared phototransistor, NPN (Radio Shack 276-145 or equiv.)

#### Additional Parts And Materials

B1—12-volt deep-cycle battery  
RY1—5-volt relay, single-pole, double-throw (Radio Shack 275-240 or equiv.)  
1—12 volt type "T" or "CD" automobile ignition coil  
1—13.8-volt, 1-watt photo-voltaic panel  
1—6-inch modular solderless breadboard (Radio Shack 276-174 or equiv.)  
1—6-inch modular PC board (matches solderless breadboard, Radio Shack 276-170 or equiv.)  
Weather-tight automobile battery storage case, TO-3 heat sink, conductive-foil tape, wire, glossy-white boards or plastic panels, lumber for trap construction

#### Sources of some materials

Automobile ignition coil obtainable from J. C. Whitney Co., 2233 S Throop St., Chicago, IL, 60608 or most automotive parts store.  
Solar panels obtainable from Edmund Scientific Co., 101 Gloster Pike, Barrington, NJ 08007-1380; from H & R Co., 18 Canal St., P.O. Box 122, Bristol, PA 19007-0122; and Integral Energy Systems, 109 Argail Way, Nevada City, CA 95959.

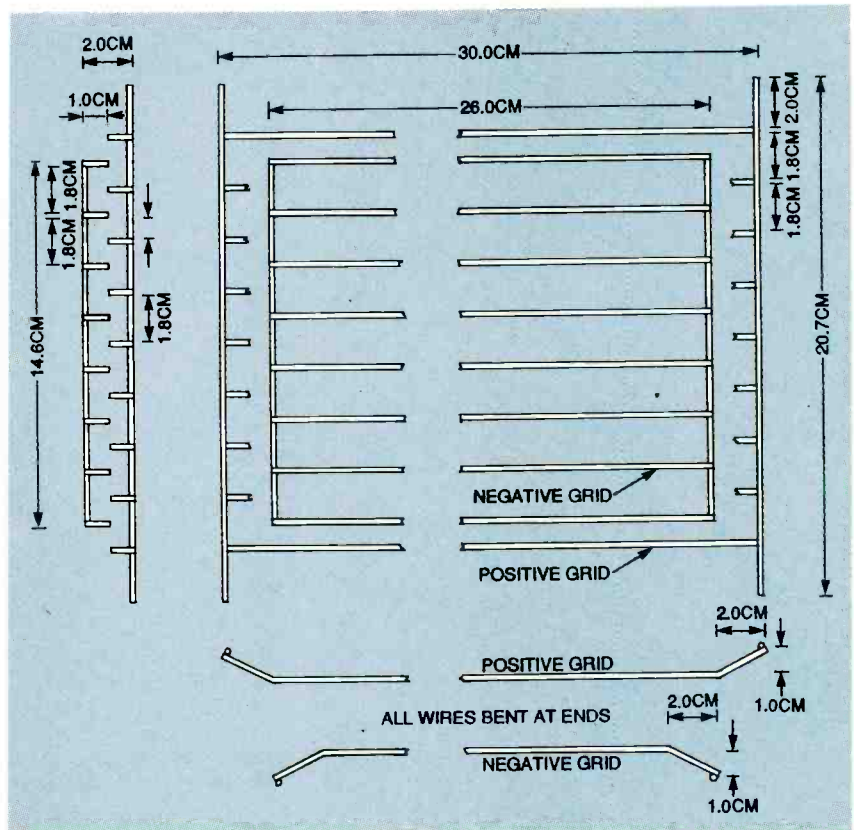

FIG. 3—THE GRID for the solar-powered fly controller is fabricated from stiff wire that can be assembled with solder, braising material, or by welding. No. 12 solid copper wire without insulation is a good choice. It forms easily and solders well with a 100-watt iron. (Note: 2.54 cm equals 1.0 inch.)

high-voltage spikes produced by the switching voltage across the relay's coil. The switching circuit is turned off at night or during periods of heavy cloud cover by phototransistor Q3 whose internal resistance increases as the ambient light diminishes. This reduces the positive bias on Q1's base, causing the transistor to cut off. LED1 serves as a voltage dropping device.

Single-pole, single-throw relay RY1 provides brief pulses of the 12-volt battery voltage to IC3, an NE755 timer that is wired as a free-running audio-frequency pulse generator. The pulses are amplified by a 2N3055 power amplifier transistor, Q2. The output of Q2 drives an automobile ignition coil, T1, to generate the high-voltage pulses for the external grid. The output voltage at the secondary winding of T1 is approximately 12,000-volts peak-to-peak.

The circuit is powered by a 12-

volt rechargeable lead-acid or nickel-cadmium battery. A 1-watt or better solar panel of the type used to keep automobile batteries charged should be used to eliminate the need to recharge the battery frequently. Many different solar panels are available on the surplus market where the price is considerably less than buying new for catalog suppliers.

#### Building the controller

The parts for the controller first are assembled on a solderless breadboard with the 12-volt battery, solar panel and ignition coil off the board. Install C6 as close to the T1 primary winding as possible. Power the unit up and be sure the circuit is functioning. Check for a spark at the center terminal of the ignition coil.

Remove the parts one at a time and mount them on a matching PC board. Figure 2 shows the author's layout on a solderless board. Put the wired

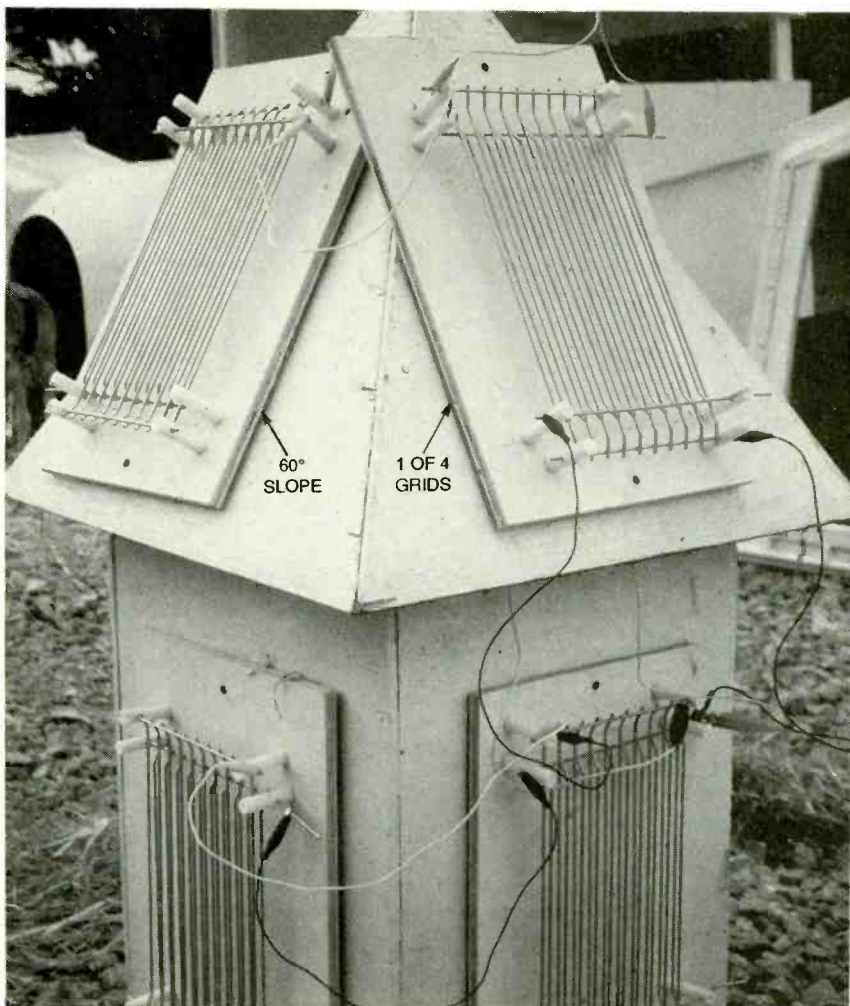

FIG. 4—THE GRIDS ARE MOUNTED on a box form, called a trap, (each controller can support up to four grids), that houses the controller and rechargeable battery. The solar cells may be mounted on a short mast and sloped to catch the maximum sunshine available.

PC board aside until it is needed.

### The high-voltage grid

The grid is made up of two comb-like elements (Fig. 3) which are spaced 5 mm apart from edge to edge. (Note: 25.4 mm equals 1.0 inch.) The grid elements can be constructed from 16 gauge wire (i.e. a coat hanger), from conductive foil, or from a combination of foil and wire. A good alternative is #12 bare, solid, copper wire used by electricians to wire houses.

The grid should be mounted on high-gloss white wooden or plastic panels and the panels should be mounted either vertically or with a sixty degree slope from the horizontal (see Fig. 4). Porcelain standoffs electrically isolate the grid from the

panels that could become conductive when wet. The terminal for the case of the transformer T1 (if it has one) is grounded to earth as is the negative input of the primary and secondary windings. One terminal of the grid is connected to the same common ground. The high voltage line from the secondary winding is attached to the other grid terminal. One controller circuit can easily power four grids.

### Operation of the trap

To eliminate flies, place four grids on a specially constructed stand as shown in Fig. 4. This configuration is called a trap. The slope of the grids mounted at the top of the trap is sixty degrees from the horizontal. The grids are mounted on adjacent surfaces of the trap. Place



FIG. 5—VIRTUALLY ANY automobile ignition coil can be used for T1.

one trap to the north, and one to the east of places where flies gather. Good spots are at the eastern ends of buildings which house animals, near dog kennels, and near garbage cans or dumpsters. For best results, check the traps once a day and remove any insects or debris which have become lodged in the grids and are shorting the grid.

### Safety concerns

Although the current available at the controller's grids is very small, the voltage is high enough to jolt a person. Therefore, power to the controller should always be turned off before handling any part of the circuit or grids. Also, the device should not be used where children can reach it. A high-voltage warning sign will keep curious adults away.

The solar-powered fly controller shown in the photographs has been in use for five years to control flies around kennels, garbage cans and in animal pastures. Several controller circuits and traps have been assembled and put to use at indoor and outdoor locations. None had any down time because of malfunction. If sufficient sunlight and an adequately sized solar panel are present, the batteries will remain charged for the life of the trap. Ω

## TROUBLESHOOTING

continued from page 42

gate an excessive current draw; check for worn-through insulation, a seized or tight engine, and a faulty starter. If the starter turns the engine slowly, the current draw is not high, and the battery is in good condition, check the resistance in the starter circuit. Its brushes may be defective, making poor contact or the commutator of the armature may be dirty.

Added resistance in the starter circuit causes the starter to turn slowly. For example: In a starter system drawing 200 amps, 0.01 ohms of added resistance in the starter cable will cause a 2 volt drop in voltage at the starter's armature. A 0.01 ohm resistance is too small for all but the most expensive and sophisticated ohmmeters to measure. However, you can measure a voltage drop indicating where there is excessive resistance (Fig. 3). Determine if there is resistance in the circuit by measuring the voltage drop across each connection and component in the starter circuit. Do this while cranking the engine. Measure the voltage drop between the battery post and the connecting cable, the solenoid posts and the wires that attach to them, and across the solenoid itself. Also, check the connection on the starter, alternator (feed and ground side) and the ground strap connection to the engine block. A logical test sequence would be to start by first measuring the battery voltage between the + and - terminals when the starter is cranking. Then measure the voltage between the starter terminal and engine block when cranking. If the starter voltage is significantly less, use our just completed procedure to isolate the voltage drop. The corrective action is usually indicated by the fault's location: clean and tighten poor connections, replace defective cables, etc.

### Ignition systems

If your engine has breaker points in the distributor, use

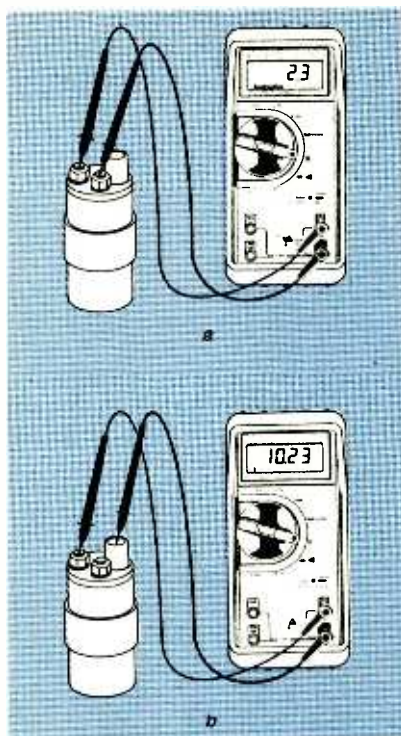

FIG. 4—USING A DIGITAL MULTIMETER to check the continuity of the primary (a) and secondary (b) windings of an ignition coil. Resistive values shown are typical for these coils.

your multimeter to measure the resistance across the contacts when the points are closed. The reading should be very low, typically 0.1 to 0.3 ohms.

The primary and secondary windings in the ignition coil can also be measured for resistance (see Fig. 4). If your digital multimeter has an automatic ranging feature, use the manual ranging feature on the multimeter to avoid any oscillations between ranges that can sometimes be caused by the inductance of the coil.

Ballast resistors in series with the coils primary winding can be measured. Look for low values in the range of 0.5 ohm. A word of caution: Connecting and disconnecting the battery source in the digital multimeter across the primary winding of the ignition coil will cause a high-voltage surge in the secondary winding. The shock experienced is usually minor. However, an involuntary sudden movement by you might cause a bruising injury or worse.

If you suspect a malfunction-

ing ignition coil, check the resistance of primary and secondary windings. Do this when the coil is hot, and again when it is cold. Expansion and contraction may open a coil winding. Also measure from the case to each connector. The primary windings should have a very low resistance, typically from a few tenths of an ohm to a few ohms. The secondary windings have a higher resistance, typically in the 10-kilohms to 13-kilohms range. To get the actual figures for a specific coil, check the manufacturer's specifications.

### Condensers (capacitors)

Shorted condensers are a common problem. Many experienced boaters replace them at the beginning of every season (or once a year where the boating season is year round) and keep a spare condenser onboard for emergency replacement when away from the dock. Your multimeter is a valuable tool that can check the capacitor's usability. Set the multimeter to the ohms range and observe the meter reading or bar graph indication. The battery in the multimeter will charge the capacitor from zero volt to the battery potential causing the ohms reading to increase from zero to infinity for a good condenser. A leaking condenser will have a finite resistance, indicating that you should replace it.

Be sure to reverse the leads to the meter and check current flow both ways. Also make sure to check condensers, both hot and cold. Leaking condensers do not give an infinity-ohms reading.

### Spark plug wires

Most modern gasoline engines have resistance wire for the high-voltage connections from the distributor cap to the spark plugs. The internal resistance within the wire reduces radio interference and produces a cleaner spark. Plug wires should be checked for open circuits if they are more than two years old. A common sense approach is to replace plug wires biannually. Keep a few of the longer old plug wires aboard for

emergency replacements when not at dockside. Due to the heat of the spark plug insulator, a spark plug boot may bond to the spark plug. Pulling a spark plug boot straight off the spark plug can damage the delicate conductor inside the insulated wire. Rotate the boot to free it before pulling it off.

If you suspect bad wires, test the resistance of the wire while gently twisting and bending it. Resistance values should be about 10 kilohms per foot depending on the type of wire being tested; some may be considerably less. You should compare readings to other spark plug wires on the engine to provide a relative reference for a typical good reading.

### Outboard motors

The ignition troubleshooting procedure for outboard motors given here can be used for any small one- or two-cylinder gasoline engine using a breaker-point magneto ignition. This type of ignition is commonly found in lawn mowers, chainsaws, emergency-power generators, snow throwers, etc.

In order to start, the engine requires three things:

- a. The proper amount of fuel/air mixture,
- b. A properly timed spark,
- c. Some piston compression.

If the engine won't start, chances are that one or more of these items is missing. The troubleshooting logic is straightforward: Find out which critical items are miss-

ing, why and repair.

Before getting into the actual procedure, verify that the fuel tank has a sufficient quantity of fresh fuel mixture and if your engine has an electric starter, use the DC volts function on your digital multimeter to check the battery voltage. Use the ohms function to check the cables for loose or corroded connections. The battery system may be smaller than a multi-horsepower marine engine, but the troubleshooting techniques previously discussed apply here.

With reference to the ignition system, here is a list of the critical components listed in the order of their likelihood of failing: spark plug, breaker points, coil, high-voltage wire, condenser and flywheel magnet.

### Spark plug check

We will assume you have already tried the normal starting procedure, i.e., turned the engine over a number of times, first with the choke closed and then open. Remove the cowling (if necessary) to gain access to the spark plugs. For a twin cylinder engine, label the spark plug wires so that they can be replaced in the correct order. Pop the wires off and unscrew the spark plug(s). Keep track of which plug came out of which cylinder.

Examine each plug carefully. This is like palm reading; the condition of the plug tip can tell a story about what is going on in each cylinder. If the plugs are

wet with gasoline, fuel is undoubtedly reaching the cylinders. If the plugs are dry, the opposite is true. Look for a blockage in the fuel system or a bad fuel pump in a remote tank.

If the plug(s) are fouled with carbon and/or oil, several things could be wrong. The spark to the plug(s) is weak or non-existent. The spark plug heat-range is too cold. (Check the engine's manual to determine the recommended plug type.) Another possibility is the engine has been run for long periods of time at low speeds, maybe with an incorrect fuel or fuel/oil mixture. In the case of multi-cylinder engines, if only one plug shows difficulties, the problem is likely to be a weak spark from the ignition system or a defective plug.

The next step is to check actual spark plug operation. If new plugs are available, use them. If not, clean the old ones as follows: Using a sharp object such as the point of a safety pin or a straightened fish hook, scrape off the deposits on the insulator surrounding the center electrode. Dig down between the insulation and sidewall and remove as much deposited carbon as possible. Now, wash out any remaining oil or carbon particles with a non-conductive solvent such as paint thinner or unmixed gasoline. Allow the plug to air dry; blow on it if necessary.

Next, gap each plug by tapping or bending the outer electrode. If you don't know what the recommended gap is, use 0.025" (a bank credit card is typically .030"). Test each plug and high-voltage wire combination by connecting the wire to the plug and laying the plug on the engine block where the gap can be seen. The plug's outer body needs to make electrical contact to the engine's metallic block, just as it does when it is screwed in place. Now, turn the engine over at normal cranking speed and watch for a spark. If you are in bright sun, you may have to shade the plug to see the spark. If this test shows no spark, or a weak spark, the trouble is with the breaker points or the coil

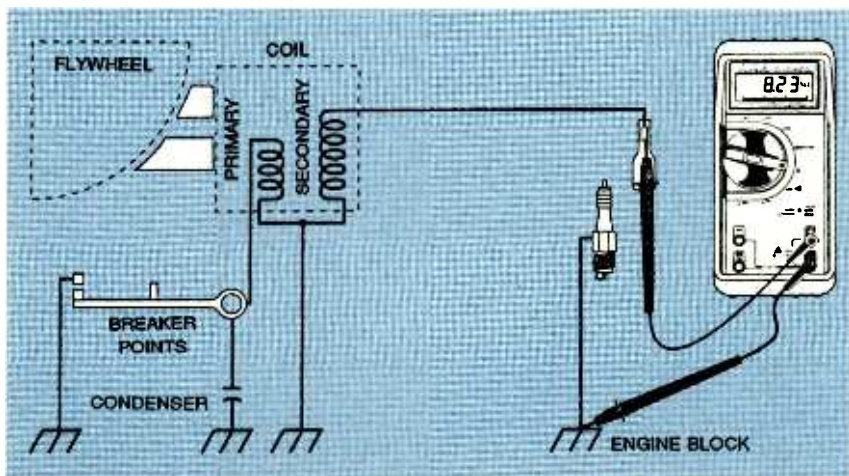

FIG. 5—CONTINUITY TESTS for the high-voltage wire.

inside the magneto. A strong spark indicates that the plugs were fouled and you corrected the problem.

The next test checks for a continuous path for the spark through the high-voltage wire and the ignition coil (see Fig. 5). For a one-cylinder engine, there is a direct electrical path from the plug cap through the high-voltage wire and ignition coil to the engine block. This can be checked without taking the magneto apart as follows: Set the multimeter to the ohms function. Use the range button to manually select the 40 kilohm range.

Now, touch one probe tip to the engine block and the other to the metal connector inside the plug wire cap. The meter should read the resistance of the coil and high-voltage wire in series. Good readings will range from 3 kilohms to 15 kilohms. Higher readings mean a poor connection or cable. A poor connection typically occurs either where the high-voltage wire connects to the coil or at the other end where the high-voltage wire connects to the spark plug clip inside the cap. An infinite resistance reading means that there is an open circuit or break in the electrical path. If you get a bad reading, check again and make sure you are making a good connection with both test leads.

### Continuity test

If you are testing a 2-cylinder, 2-cycle engine (mixed fuel), perform this test for each cylinder individually. Look for a correlation between a bad reading and a fouled spark plug on the same cylinder.

If the engine is a 4-cycle model (unmixed fuel), such as a Honda or Onan, the test is performed slightly differently, as shown in Fig. 6. You should expect continuity from one spark plug clip to the next since there is only one secondary winding. The secondary winding is not connected to the engine block. However, an open spark path will kill the spark to both cylinders.

A break in the high-voltage

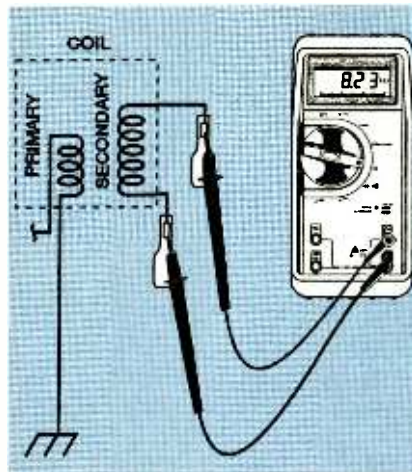

**FIG. 6—RESISTANCE/CONTINUITY TEST for 2-cylinder, 4-cycle engines. Note that there is no distributor and that both plugs fire at the same time.**

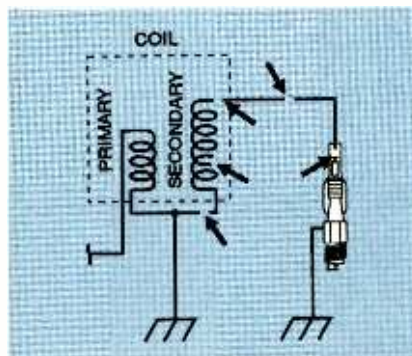

**FIG. 7—LOCATION OF possible circuit interruptions in the secondary winding, high-voltage circuit.**

circuit can occur in several places as shown in Fig. 7. If the poor connection or open circuit occurs at the spark plug clip, you may be able to repair it without taking anything else apart. If the problem is located inside the magneto, it will probably be necessary to remove the flywheel.

### Breaker point test

The breaker points on a magneto ignition are often located under the flywheel. Remove any parts obstructing the flywheel's removal. Hold the flywheel in a stationary position with a strap wrench and remove the large nut that holds the flywheel to the crankshaft. Use a puller to loosen the flywheel and lift it off the crankshaft. Locate the breaker points and examine the contact surfaces. Caution here: when rotating the crankshaft,

turn it in the forward direction only to prevent damage to the water-pump impeller.

For proper operation, the breaker-point contact surfaces should be clean and shinning. Make an electrical resistance test with your digital multimeter before attempting to clean the contact surfaces. This provides a before and after indication. Refer to the diagram in Fig. 8. Note the points are in parallel with the primary winding of the ignition coil and condenser. When the points are open, the resistance across the coil will be about 1 ohm (the winding's wire resistance). When the points (with clean contacts) are closed, the resistance falls to 0.1 to 0.2 ohms. Any oil or corrosion on the point contact surfaces increases the resistance and reduces the primary winding current. This subsequently weakens or kills the spark.

Measure the contact resistance as follows: Place the multimeter in the ohms function. Hold the probe tips tightly together to obtain a reference reading with the tips shorted. The reading should show zero (0.0) ohms. If not, note the value. This is the reference reading.

Now place the probe tips on opposite sides of the point contacts when the points are in the closed position. The meter should now read no more than 0.1 ohm greater than the reference reading. Higher readings indicate contamination on the contact surfaces. If the contact surfaces are pitted, the best choice would be to replace the points. If you can't install new ones, then carefully clean the ones you've got. The object here is to remove all contamination without damaging the underlying metal.

A small plastic block on the breaker points rides a rotating cam that opens and closes the points. If this block shows signs of wear, or is shortened by wear, replace the breaker points to avoid future problems.

The preferred cleaning method is to remove the contaminants from the points'

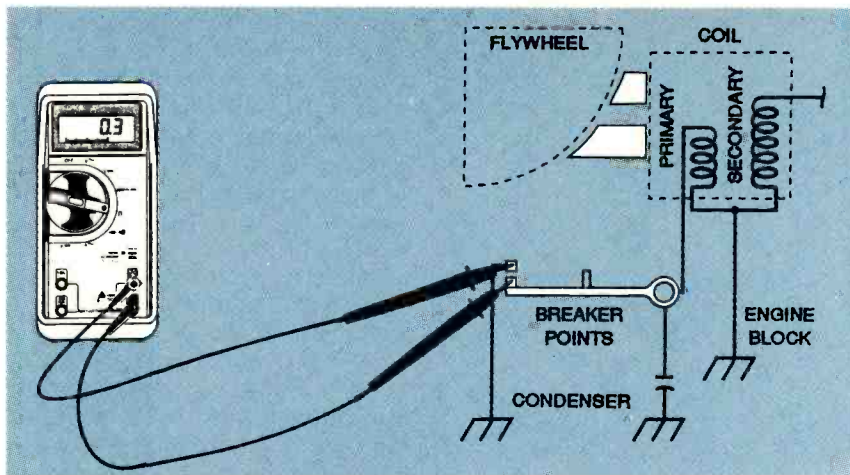

FIG. 8—TEST METHOD for determining breaker point contact resistance.

surfaces as well as metallic oxides that build up. A fine bur-nisher (a very fine, paper-thin file) is slid over the points' surfaces as the points are gently held closed.

Emergency cleaning methods must be used at times. Scrape the contact surfaces with a sharp carpet-layer's knife. You could file the surfaces with the abrasive surface of a matchbook striking surface—it functions like a fine file. Next, wipe the contacts with solvent on a clean cloth. Away from the dock use ordinary gin or vodka. Filing sometimes work, but there is a risk of damaging the underlying metal. This shortens the life of the contacts. Never use course sandpaper! The grit imbeds itself in the contact metal, rendering the points useless. If you have any doubt about the perfect condition of the points, replace them!

If you want a quick fix to get the engine running in an emergency situation, try the following: With the crank shaft positioned so that the points are closed, gently pry the breaker arm open. Next, insert a clean business card between the contact surfaces. Release the breaker arm so that the points grip the card through its width. This wipes the contacts in the process. The card has two beneficial properties. It is absorbent enough to remove oil and is just gently abrasive enough to remove surface contamination.

When you think the cleaning is complete, verify the results by

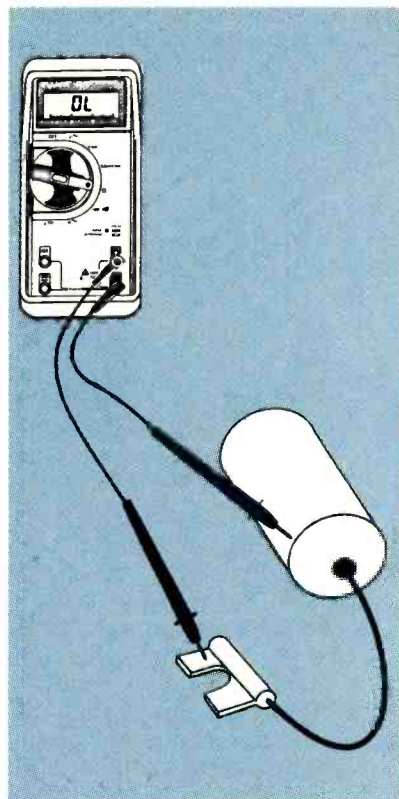

FIG. 9—CHECKING THE IGNITION condenser for leakage.

repeating the electrical resistance test. Before leaving the points, make a visual inspection of the gap in the open position. A typical specification would be 0.020 inches.

#### Condenser test

As before, check the condenser as follows: Disconnect the condenser lead, then place the multimeter in the capacitance function and hold one test lead to the capacitor case and

the other to the terminal. (See Fig. 9).

Do not touch both leads with your fingers simultaneously because it causes reading errors. A typical range of good readings would be .015  $\mu$ F to .030  $\mu$ F. If the DMM indicates an overload in the capacitance function, the condenser is shorted. A very low capacitance reading probably means the condenser is open. Condensers are not repairable so a bad reading will likely mean a trip to the parts store.

If your multimeter does not have a capacitance function, use ohms instead. This test is best performed with the ignition condenser removed from the engine. Start by shorting the condenser by touching the lead to the case. Now, touch one probe to the lead and one to the case. Don't touch the probe tips or exposed condenser parts with your fingers. Watch the meter reading as the condenser is charging for indications that it is leaking or shorted. Now reverse the test leads and repeat the test. The results should be the same. If the results are negative (no bad indication), the condenser is good.

#### Flywheel magnet test

Flywheel magnet failures are rare but sometimes do occur. You can verify the strength of the magnet with a simple test. Locate the inside surface of the flywheel that travels near the pole pieces of the coil. You will find some magnetic material (typically laminated steel) in two places. It's separated by a gap of non-magnetic material (typically aluminum). Lay a hacksaw blade on the laminations near the gap. If the magnet is good, it provides a strong pull on the hacksaw blade. If not, refer to the engine's manual for replacement parts.

#### Reassembly and final check

Once you've checked out and repaired the ignition system, reassemble the engine and repeat the spark plug test. If the spark looks good, install the plug(s) and try again to start the engine. If troubles persist, inspect the fuel system. Carburetor

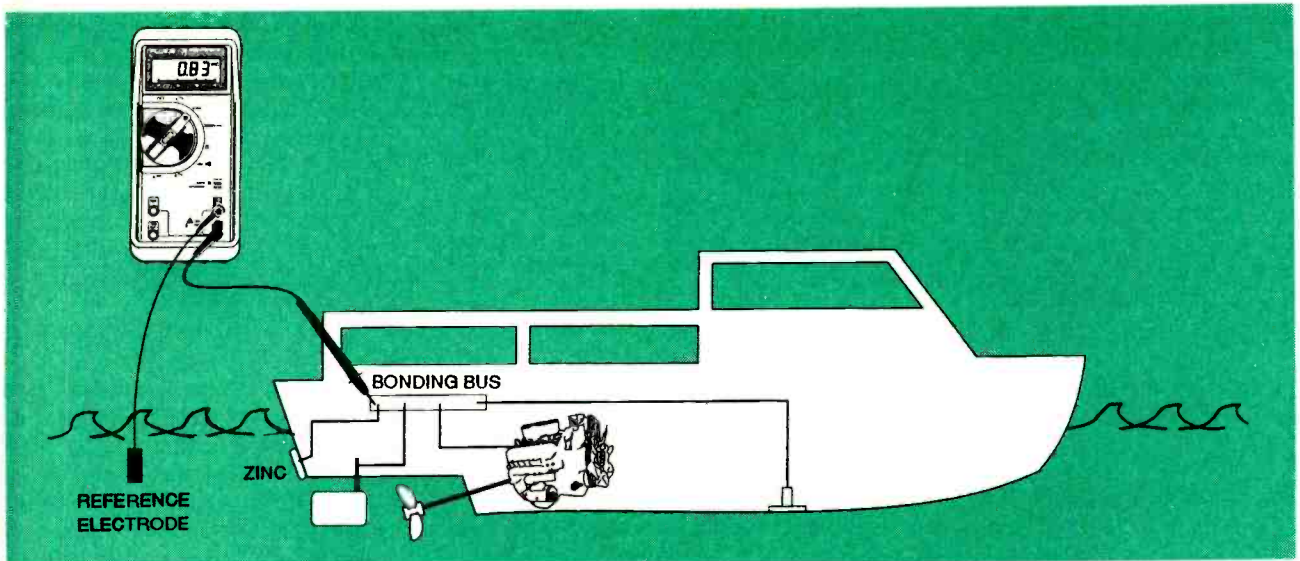

FIG. 10—TESTING THE CORROSION protection on your boat using a reference electrode.

cleaning may be required. Remember, most engine manufacturers recommend the addition of fuel stabilizer for long periods of storage.

**Corrosion control**

The corrosion protection system on your boat should be checked at regular intervals. Neglect leads to costly and time-consuming repairs. In order to perform the checks detailed here, your digital multimeter should be accurate, rugged and reliable; and, most important, it should have a 10-megohm input impedance in the DC-volts function. The high-input impedance allows you to test your boat in either fresh water or salt water, with repeatable results.

In general, the term corrosion refers to the unwanted loss of metal from the hull and/or underwater metal fittings of the vessel. There are two main types of corrosion—mechanical and electrical. Mechanical rust is common everywhere; a piece of metal rusts because it oxidizes. Under the electrical category, there are three common sub-categories: galvanic corrosion, stray current corrosion, and crevice corrosion.

*Galvanic corrosion* occurs when two dissimilar metals are connected together electrically in the presence of a conductive electrolyte. The water about the hull, either fresh or saline, is

the electrolyte. Atoms in the less noble metal give up their electrons to the more noble metal and the atoms with one or more electrons missing are released to flow (corrode) into the electrolyte in the form of positively charged ions.

*Stray current corrosion* occurs when a voltage source pulls electrons out of the metal. The voltage source might be the boat's lighting system, charging system or even elements of the communications system. In fact, some or all of the electrical system provides the stray current through ground loops commonly associated with audio systems. This corrosion allows the positively charged ions to flow into the electrolyte as previously described.

*Crevice corrosion* is actually a form of galvanic corrosion. However, it involves only one metal. A portion of the metal (in the crevice) becomes active (less noble) due to a loss of oxygen while the remainder stays passive. If an electrolyte is present, a galvanic couple is formed and the active metal is converted to ions and enters the electrolyte solution.

Materials used in the construction of marine vessels are chosen using various criteria. These include cost, mechanical strength, workability and corrosion resistance. When you want to compare metals according to

their corrosion resistance, you refer to a ranking list called the Galvanic Series of Metals first learned in high school chemistry. This is often referred to as the "noble scale." This scale indicates the relative boundlessness each metal has for its electrons, i.e., it ranks the metals according to their electron bonding strength.

Metals at the active (less noble) end of the scale yield electrons and corrode more easily than metals on the passive (more noble) end of the scale (see Table 1).

Underwater metals can be protected if they are supplied with sufficient extra electrons. Active metals like zinc protect the more noble metal, iron. If the two metals are immersed in

TABLE 1—GALVANIC SERIES OF METALS

<b>Active</b> (least noble)	Magnesium
	Zinc
	Aluminum
	Cadmium
	Steel
	Iron
	Brass
	Tin
	Copper
	Bronze
	Lead
	Titanium
	Silver
	Platinum
<b>Passive</b> (most noble)	Gold

Alloys may vary according to composition

the same electrolyte, and deliberately connected by an electrical bonding system, the zinc liberates its electrons and, in time, the zinc is dissipated. This chemical action protects the iron from corroding and the loss of the zinc is relatively inexpensive compared to the damage caused by corrosion. In this configuration, the zinc is called an *anode* and the protected iron is called the *cathode*. This setup is the familiar principle of an operating battery.

### Reference electrode

When a metal is in contact with an electrolyte such as sea water, the metal establishes a natural potential or voltage with respect to the electrolyte. This natural potential (or "freely existing" potential) exists when no extra electrons are being supplied or removed by an outside voltage source. You can measure this potential with a digital multimeter and a refer-

**TABLE 2—SAMPLE READINGS**

Metal	Free Unprotected*	Protected*	Over Protected*
Steel	0.05V	0.75V	1.00V
Bronze	0.30V	0.55V	0.80V
Aluminum	0.65V	0.90V	1.05V

\* Voltages given in this table are typical values obtained using a silver/silver-chloride reference electrode. Values may vary according to alloy and type of coating.

ence electrode. The reference electrode allows you to make an electrical connection to the sea water with a known, repeatable value, i.e., a reference value.

Reference electrodes are often called half cells because they contain a metal and a metal compound. Popular types are copper-copper sulfate and silver-silver chloride. Marine system tests are often conducted with a silver-silver chloride electrode (see description in Reference 1).

The principle of the test is straightforward: You want to establish the corrosion protection system by supplying electrons. The trick is to supply exactly enough electrons to raise the potential of the protected metal 250 millivolt (1/4 volt) above the freely existing value. The test procedure is as follows (Refer to Fig. 10):

1. Set a multimeter to DC volts.
2. Connect the reference electrode to the volts input jack. Place the reference electrode in the water. Best results are obtained when the electrode is located away from the anode.
3. Connect the multimeter common jack to a probe that will be used to contact each piece of underwater metal.
4. Touch the common probe to each underwater metal fitting and record the millivolt value as displayed on the meter. If all underwater metal fittings are connected together with a bonding system, as shown in Fig. 10, then all readings should be identical. Some typical values for several metals are listed in Table 2.

Over-protection causes paint to peel from a metal hull, or chemical damage to a wooden hull. References 1 and 2 explain the dangers of over protection and details about bonding systems. In all probability you might be able to borrow a reference electrode from your marina's electrical shop.

Boating is a pleasure sport that can have serious consequences should preventative maintenance be avoided and minor problems ignored. Your boat is the only thing between you and Davy Jones locker. Keep it in excellent condition with a power plant that delivers every time you crank the motor over.  $\Omega$



# Reaching New Heights

The National Professional Service Convention and Trade Show

at  
**NPSC '96**  
(Formerly NPEC)

August 5-10, 1996  
Special 3-day packages available Aug. 5-7 & Aug. 8-10

Hyatt-Regency @ Union Station  
St. Louis, Missouri

---

**HANDS-ON TECHNICAL SEMINARS FOR PROFESSIONALS**

- Two Day PC School
- Big Screen TV Coverage
- Building and Troubleshooting Computer Networks and many, many, more!
- All day Monitor School
- Introduction to DVD

Courses **FREE** when registered at the National Professional Service Convention August 5-10, 1996, St. Louis, MO

**Full \$300 Registration (at door) includes:**

- All Technical Training Seminars (limited seating)
- All Management & Business Seminars
- Head-to-head Meetings with Manufacturers' National Service Managers
- All Sponsored Meals and Functions
- NESDA / IS CET / NIAS Association Meetings
- Continuing Education units for all seminars attended
- Price discounts available for pre-registration

Sponsored by: National Electronic Service Dealers Association, International Society of Certified Electronics Technicians, National Independent Appliance Servicers, Professional Service Association

**For more information, contact NPSC '96**  
2708 W. Berry St., Fort Worth, Tx 76109-2356 (817) 921-9061; Fax (817) 921-3741

**References for Additional Information**

1. *Boat and Yacht Corrosion Control*; by Yacht Corrosion Consultants, 2970 Seaborg Avenue, Ventura, CA 93003.
2. *Boatowner's Illustrated Handbook of Wiring*; by Charlie Wing, International Marine, Camden, Maine.
3. *Your Boat's Electrical System*; by C. Miller and E.S. Maloney, Hearst Marine Books.



## SCOPE ADAPTER

*continued from page 44*

standard universal component board with power buses that measures  $1\frac{7}{8} \times 2\frac{3}{4}$  inches. A larger board will fit in the case, but it is important that the signal leads be kept as short and direct as possible. They must also be electrically isolated from each other. If the circuit board does not have mounting holes in the corners, drill them at this time.

Refer to the parts placement diagram, Fig. 2. It is recommended that you lay out the components on the board first, following the general locations shown in Fig. 2, to be sure that you have an appreciation for the size of the components before you begin to insert and solder them. Avoid running DC signal lines parallel to AC lines when you wire the board.

Cut off pins 1, 2, 13, and 14 on the 14-pin DIP socket (these pins are not connected within IC1). Install the socket flush with the edge of the circuit board. (This saves solder pads on the circuit board.) Install and solder the three 8-pin DIP sockets, leaving space for resistor R2, transistor Q3, and capacitors C4, C6, and C7. Install and solder R15, R26, Q1, Q2, and Q3. Then install the remaining passive components, leaving long leads where necessary for interconnections to the board and front and rear panel controls and jacks.

Make the power connections on the under side of the board to the power bus strips. Power lines from J3 go to IC1. NOTE: The  $\pm 5$  volts required by resistor R6 is taken directly from J3. Double and triple check the wiring, looking particularly for inadvertent solder bridges or cold solder joints. Make any corrections necessary at this time.

### Mechanical work

Refer to the assembly diagram Fig. 3. Begin the mechanical part of the project by locating, center-punching, and drilling or forming all of the

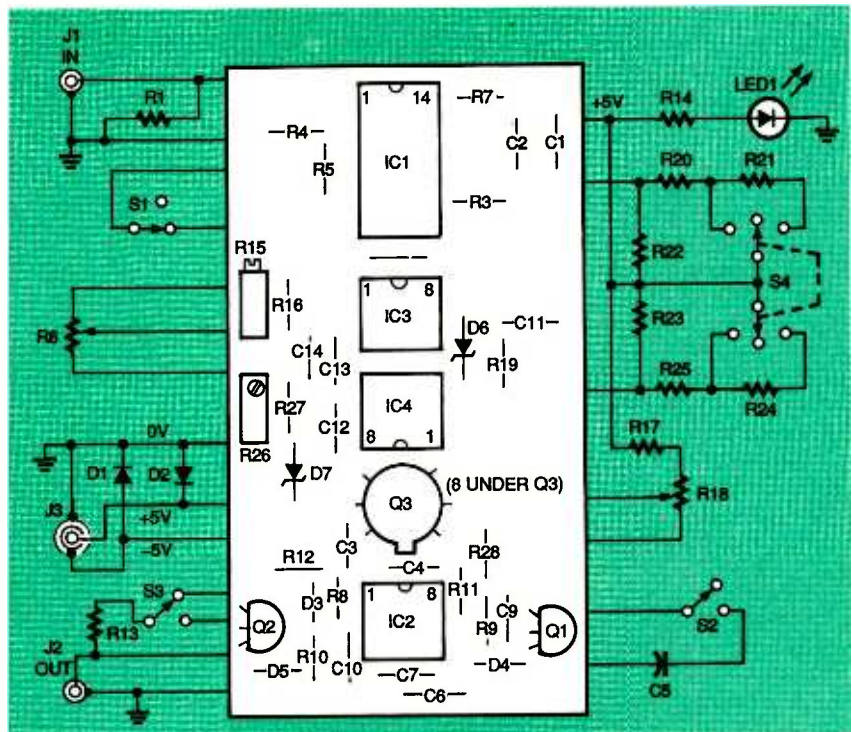

FIG. 2—PARTS PLACEMENT DIAGRAM for the adapter showing approximate locations of components on the circuit board. Many other components are chassis mounted and wired to the circuit board.

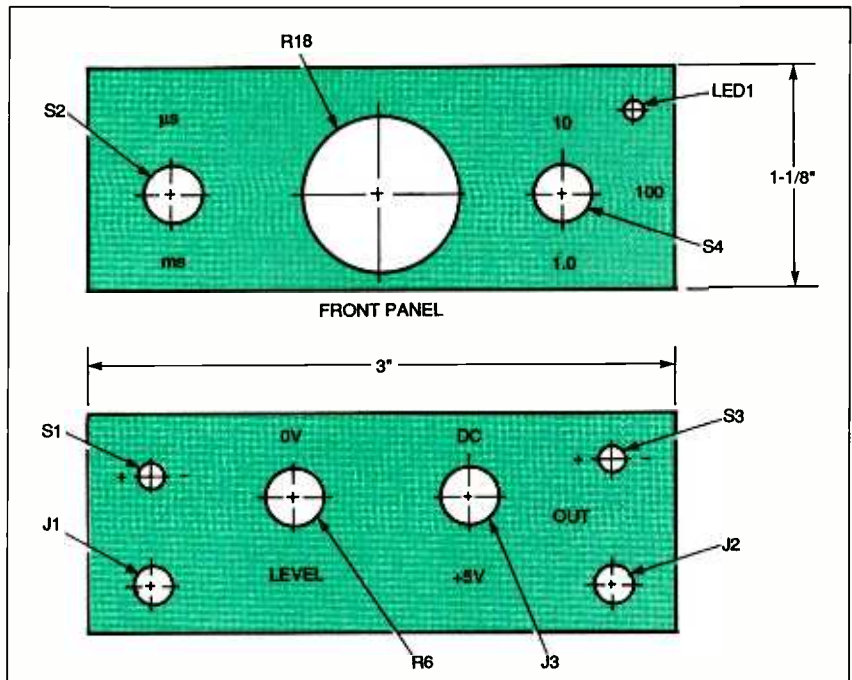

FIG. 3—DRILL PATTERN AND LABELS for the end panels of the lower half of the project case.

holes on the front and back vertical panels on the lower half of the case, using Fig. 3 as a guide. Drill or form the holes on the front panel for LED1, S2, S4, and precision potentiometer R18. Drill the hole for LED1 just

large enough to permit a press fit of the top of the lens. Then drill the holes in the back panel for S1 and S3, R6, and J1, J2, and J3.

Using the circuit board as a template, locate, center punch

## PARTS LIST—DUAL OSCILLOSCOPE ADAPTER

All resistors are ¼-watt, 5%, unless otherwise specified.

- R1—51 ohms
- R2, R5, R7—470 ohms
- R3—120,000 ohms
- R4—15,000 ohms
- R6—10,000 ohms potentiometer, ½-inch dia. shaft
- R8—10,000 ohms
- R9, R10—5600 ohms
- R11, R12, R14—680 ohms
- R13, R28—1000 ohms
- R15—100 ohms, cermet trimmer potentiometer, multiturn
- R16—4020 ohms, 1%, metal film
- R17, R20, R25—100 ohms, 1%, metal film
- R18—1000 ohms, 10-turn, precision potentiometer, Bourns 3540S or equiv.
- R19—150 ohms
- R21, R24—1000 ohms, 1%, metal film
- R22, R23—10,000 ohms, 1% metal film
- R26—25,000 ohms cermet trimmer potentiometer, multiturn
- R27—100 ohms

### Capacitors

- C1, C7, C13—0.1µF monolithic ceramic
- C2—47µF, 16 V, solid tantalum
- C3—100 pF, 10% ceramic disc
- C4—0.001µF, 5% polyester
- C5—1.0µF, 5% polyester
- C6—0.01µF, monolithic ceramic
- C8, C14—1.0µF, 35V, solid tantalum
- C9, C10—56 pF monolithic ceramic
- C11, C12—100 pF monolithic ceramic

### Semiconductors

- IC1—LM319, dual comparator,

National or equiv. IC2—TLC555 CMOS timer Texas Instruments or equiv.

IC3, IC4—LF356 JFET operational; amplifier, National or equiv.

Q1—2N3906, PNP transistor

Q2—2N3904, NPN transistor

Q3—2N5117 or 2N3810, matched dual PNP transistors (2N5117, Semiconductor Technologies, or

2N3810, NTE 82), T0-78 package

D1, D2—1N4001, 1-A silicon rectifier, 50 PIV

D3, D4, D5—1N4148 silicon diodes

D6—1N751A/1N5231B, 5.1 V Zener diode, 5%, 500mW

D7—1N749A/1N5229B, 4.3 V Zener diode, 5%, 500mW

LED1—Light-emitting diode, T1 case, red

### Other components

S1, S3—toggle switch, SPDT, subminiature, 1 A, panel mount

S2—toggle switch, SPDT miniature, 1 A panel mount

S4—toggle switch, DPDT miniature, center off, 1 A, panel mount

J1, J2—jack, BNC female, panel mount

J3—phone jack, ⅜ (3.5 mm) 3 conductor w/matching plug

**Miscellaneous:** circuit board (see text), Radio Shack 276-150 or equivalent; two-part aluminum project case (see text); precision potentiometer counter dial, 15-turn, Clarostat Clarodial (or equiv.); 8-pin DIP sockets, three; 14-pin DIP socket; plastic stand-offs, ⅜-inch; screws and nuts, solder.

the solder terminal strip between S4 and the circuit board, as shown in Fig. 4. This might be the right time to label the control positions for jacks, switches and potentiometers to be mounted on the front and rear panels by some convenient method, as shown in Fig. 3.

### Assembling the adapter

Insert and fasten all of the panel-mounted components on the front and back panels, as shown in Fig. 4. Install the terminal strip with a screw and nut. Refer to the off-board component schematics on parts placement diagram Fig. 2. Position and solder a length of No. 22 AWG bare bus wire from the ground lug on J1 to the ground lug on J3 and on to the ground lug on J2. Insert and solder resistor R1 on J1, resistor R13 from J2 to S3, and diodes D1 and D2 from J3 to the ground bus.

## PARTS LIST—POWER SUPPLY

Resistors are ¼ watts, 5% unless otherwise specified

R1, R2—1800 ohms

### Capacitors

C1, C2—330µF, 16 V, aluminum electrolytic

C3, C4—0.1 µF, 25 V, monolithic ceramic

### Semiconductors

IC1—78L05 voltage regulator, +5V, 100 mA, National or equiv.

IC2—79L05 voltage regulator, -5V, 100 mA, National or equiv.

BR1—full-wave bridge rectifier, 1 A, 50 PIV

LED1—light-emitting diode, red, T1 case

LED2—light-emitting diode, yellow, T1 case

**Other components** T1—transformer 120 VAC primary, 12.6 VAC center-tapped, 0.2 A

S1—toggle or slide switch, miniature, DPDT, 1 A

**Miscellaneous:** project case, (see text), circuit board, ⅜ jack, panel-mounted AC line plug, insulated hookup wire, solder, screws, and nuts.

**Note:** One source for Q3, the 2N5117 matched dual PNP transistor, is Johnson Shop Products, P.O. Box 2843, Cupertino, CA 95015, 408-257-8614

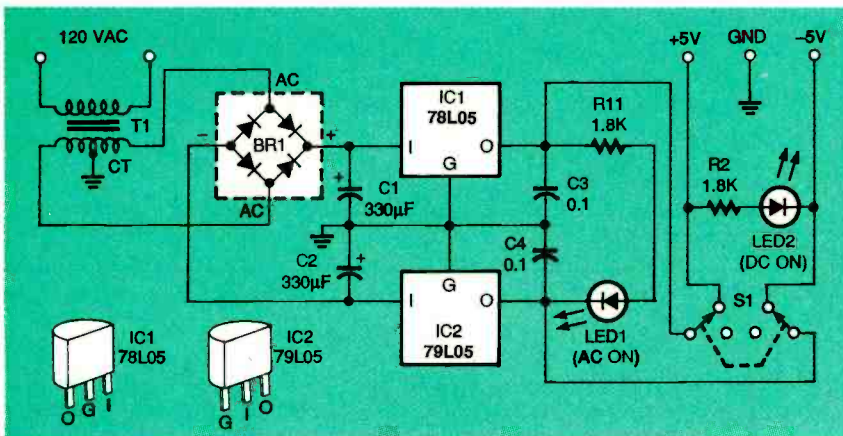

SCHEMATIC FOR A ±5-VOLT, REGULATED dual power supply.

and drill the four mounting holes approximately in the cen-

ter of the base of the lower half of the case. Then drill a hole for

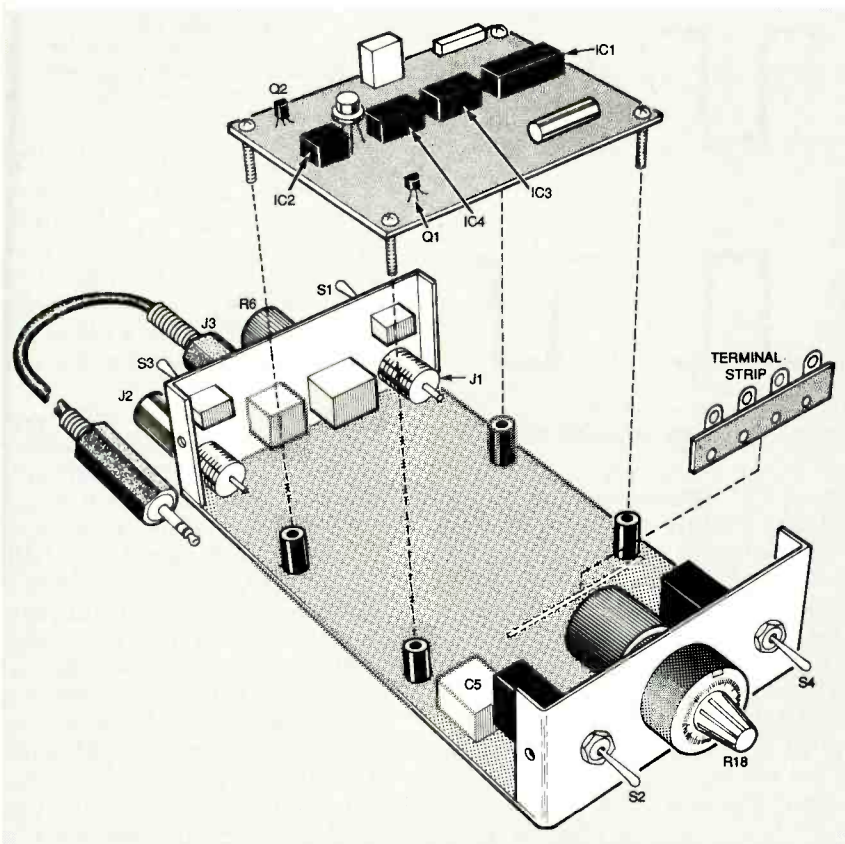
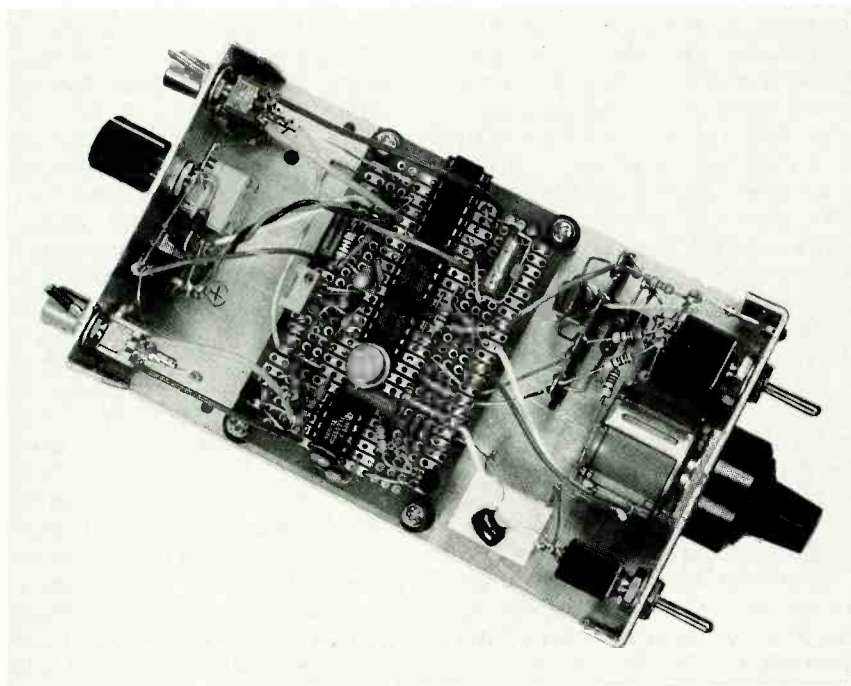

FIG. 4—ASSEMBLY DIAGRAM showing the locations of the circuit board and panel-mounted components.



INSIDE VIEW of the completed Dual Scope Adapter reveals a neat and professional-type assembly. Check that the cover causes no shorts when the box is closed.

Select one lug on the terminal strip for the +5-volt lead, one for ground (mounting lug), and

one for each emitter of transistor Q3. Install and solder R22 and R23 on the terminal strip,

R21 and R24 on switch S4, R20 and R25 from switch S4 to the terminal strip. Install and solder resistor R14 from LED1 to the terminal strip along with a ground lead from the cathode of LED1. Install and solder resistor R17 from R18 to the terminal strip. Install and solder capacitor C5 on switch S2 with a free lead ready for connection to the circuit board.

Fasten four 3/8-inch standoffs to the bottom side of the circuit-board mounting holes, position it on the base plate holes and fasten it with four screws. Connect and solder all wires from the off-board components. Again check all soldered connections for cold or inadequately soldered joints, and make any corrections necessary. Install the four ICs in their sockets.

Set multiplier potentiometer R18 as follows: Turn the shaft full counter-clockwise and install the counter so that it reads 1.00. Thus, when it is rotated ten turns fully clockwise, it will read 11.00, a range of  $\times 1.00$  to  $\times 11.00$ . To obtain the highest accuracy, measure the actual resistance of R18 and select or trim R17 (100 ohms nominal) so that:  $R17 = (R18/10) + 2$  ohms. For example, if R18 = 990 ohms, R17 will equal  $99 + 2 = 101$  ohms. The extra 2 ohms compensates for the finite gain of Q3, which causes nonlinear multiplier performance.

#### Calibration and test

Plug the power supply into jack J3, connect jack J1 to your oscilloscope's CHANNEL 1 output jack, and connect J2 to the Z axis jack. Set the trigger for a positive slope, and set S1 and S3 to (+) on your adapter. Set R6 (TRIGGER LEVEL) to mid position (zero volts) and select the 10 millisecond range as follows: Set S2 to "ms", S4 to "10", and the turns-counter on R18 to full counterclockwise.

Turn on the power supply and, with a digital multimeter, adjust potentiometer R15 on the circuit board so that about 60 millivolts is present from the +5-volt bus to pin 3 of IC3. Then set R26, also on the cir-

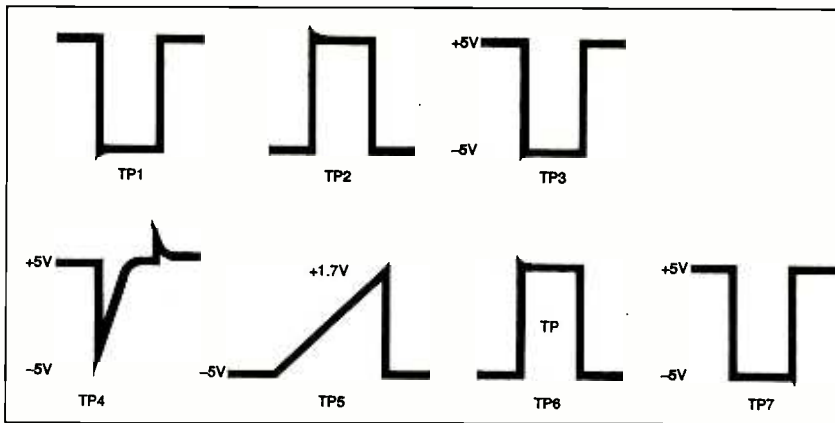

FIG. 5—OSCILLOSCOPE WAVEFORMS at selected test points, as shown on Fig. 1

cuit board so that there is a reading of 0.0 millivolts between pins 2 and 3 of IC4.

If you should encounter any problems with the circuit at this time, you might want to observe the waveforms at the test points identified in the schematic, Fig. 1. Figure 5 illustrates the waveforms to be expected at those test points.

Introduce a 60-Hz signal from a separate, low-voltage filament-style transformer to CHANNEL 1 of your oscilloscope, and display two or three cycles at about six divisions of vertical height. With the adapter set at 10 milliseconds, you should see a waveform with about 50% or more of each cycle in bold relief (intensified) with the remainder dimmed.

Adjust your oscilloscope's intensity control for the best contrast of the two parts of the trace. The positive half of each cycle should be bold. If it is not, set rear panel switch S3 (OUTPUT SLOPE) to (-), to allow the bold section to lengthen as the multiplier (R18) is advanced clockwise. Rotate the knob of panel potentiometer R6 (TRIGGER LEVEL) back and forth and observe how the cursor can be triggered at any point on the positive-going slope. (Reverse S1's position to trigger on the negative-going slope.)

Advance the turns counterclockwise, and observe the bold section lengthening towards the next cycle so that it eventually forms a complete bold trace. At this setting, the adapter output pulse is equal to the time period of the 60-Hz sig-

nal (16.7 milliseconds). A very small advance of the turns counter will cause each alternate cycle to dim. Adjust your oscilloscope's sweep speed to see this clearly, and then set the turns counter to  $\times 1.67$ . Now adjust calibration trimmer R15 to locate the trace exactly at the point where it changes from full bold on each cycle, to bold on each alternate cycle.

This completes the calibration and operating instructions for the time period mode. As expected, any type of waveform can be measured by simply manipulating the slope, range, and multiplier controls of the unit.

To use the delayed sweep mode, connect output jack J2 to the TRIGGER INPUT jack on your oscilloscope (instead of the Z axis jack). Introduce the signal to CHANNEL 1, set switches S1 and S3 to match the oscilloscope waveform's slope, and adjust the range controls to the approximate signal time period. Switch the oscilloscope to EXT. TRIGGER), and rotate the turns counter to keep that part of the signal-to-be-viewed on screen as you increase sweep speed to expand the signal.

#### Regulated power supply

A schematic for a wall outlet mounted  $\pm 5$ -volt power supply for this oscilloscope accessory is included because commercial versions are not widely available. The author built the supply into a two-part aluminum project case measuring  $3\frac{1}{4} \times 1\frac{1}{2} \times 2$  inches. These cases are standard, off-the-shelf items.  $\Omega$

60 components on a HP4275A L/C meter. Measuring these components on the L/C meter prototype found an average error of just 0.60% for inductors and 0.13% for capacitors. These values ranged from .1  $\mu\text{H}$  to 6.8  $\mu\text{H}$  for the inductors and 2.7pF to .068  $\mu\text{F}$  for the capacitors.

The prototype was also used to measure the values of a series of 5% tolerance inductors up to 150 mH, and a series of 10% mylar capacitors up to 1.6  $\mu\text{F}$ . All of these parts measured well within the specified tolerance of their marked values indicating the accuracy of the L/C meter extends at least up to 150 mH and 1.5  $\mu\text{F}$ . These measurements were made on a single unit. The measured values could vary, from unit to unit, by 1% to 2% as a function of the exact value of C2, 1% tolerance polystyrene capacitor.

The L/C meter has a four-digit resolution, which for small values of L and C are 1 nH and .01 pF. You cannot accurately measure values this small. The resolution greatly exceeds the accuracy.

You can measure values as small as .01  $\mu\text{H}$  and .1 pF with about 15% accuracy. However, you generally won't find components this small. For example a piece of wire less than one inch long has an inductance of 0.01  $\mu\text{H}$ .

The resolution of the meter is, however, relative, and can be used for sorting a batch of similar components as it truly does indicate which are slightly larger or smaller than others. Also, for small values of inductance, the leads will contribute quite a bit to the value. Measuring from the ends of the leads instead of next to the body of the component can add up to 0.025  $\mu\text{H}$ .

For small values the frequency of operation (test frequency) is about 750 kHz decreasing to about 60 kHz at .1  $\mu\text{F}$  or 10 mH and about 20 kHz at 1  $\mu\text{F}$  or 100 mH.  $\Omega$

# Electronic SHOPPER<sup>®</sup>

## Paperback Books

GREAT BOOKS AT BUDGET PRICES

**100 RADIO HOOKUPS**  
—#7—\$3.00

First published in May, 1923 this popular booklet went into reprint editions nine times. It is packed with circuits, theory, antenna installation and tips on consumer radio receivers that were popular in the early 1920's. Antique radio buffs and those inquisitive about the early days of radio will find this booklet an exciting, invaluable and excellent reference into the minds of early-day radio listeners. Sorry, we cannot honor the original 25-cent cover price.

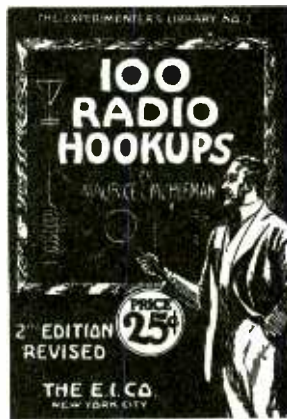

**INTERNATIONAL RADIO STATIONS GUIDE—BP255**  
—\$9.95

Provides the casual listener, amateur radio DXer and the professional radio monitor with an essential reference work designed as a guide for listening to the complex radio bands. Includes coverage on Listening to Shortwave Radio, ITU Country Codes, Worldwide Radio Stations, European Long Wave and Medium Wave Stations, Broadcasts in English and more.

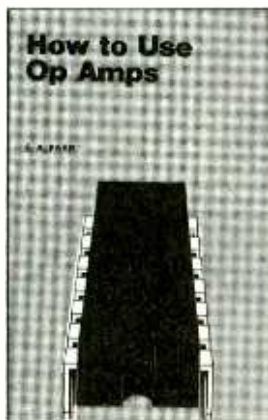
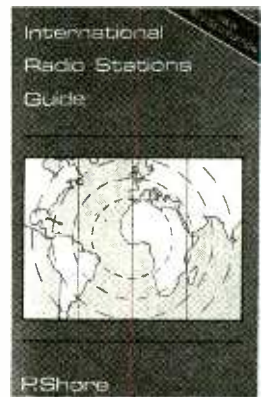

**HOW TO USE OP AMPS**  
—BP88—\$5.95

The engineer's best friend is the op amp. This basic building block is found in many circuits, analog and digital alike. The op amp finds many useful purposes such as: oscillators, inverters, isolators, high- and low-filters, notch and band-pass filters, noise generator, power supplies, audio, MIDI, and much more. Prepared as a designer's guide, some limited math is used, however engineers and hobbyists alike find it a useful text for their design needs.

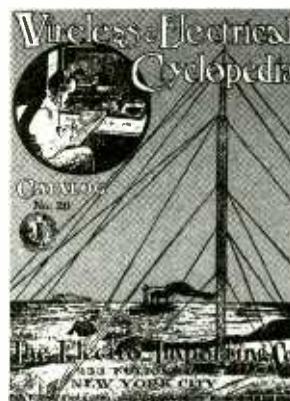

**WIRELESS & ELECTRICAL CYCLOPEDIA**  
—ETT1—\$5.75

A slice of history. This early electronics catalog was issued in 1918. It consists of 176 pages that document the early history of electricity, radio and electronics. It was the "bible" of the electrical experimenter of the period. Take a look at history and see how far we have come. And by the way, don't try to order any of the radio parts and receivers shown, it's very unlikely that it will be available.

**ELECTRONIC TECHNOLOGY TODAY INC.**  
P.O. BOX 240, Massapequa, NY 11762-0240

Name \_\_\_\_\_  
Address \_\_\_\_\_  
City \_\_\_\_\_ State \_\_\_\_\_ Zip \_\_\_\_\_

**SHIPPING CHARGES IN USA AND CANADA**

\$0.01 to \$5.00 .....	\$2.00
\$5.01 to \$10.00 .....	\$3.00
\$10.01 to 20.00 .....	\$4.00
\$20.01 to 30.00 .....	\$5.00
\$30.01 to 40.00 .....	\$6.00
\$40.01 to 50.00 .....	\$7.00
\$50.01 and above .....	\$8.50

**SORRY No orders accepted outside of USA & Canada**

Number of books ordered

Total price of merchandise .....	\$ _____
Shipping (see chart) .....	\$ _____
<b>Subtotal</b> .....	\$ _____
Sales Tax (NYS only) .....	\$ _____
<b>Total Enclosed</b> .....	\$ _____

**All payments must be in U.S. funds!**

ET01

# BLACK FEATHER ELECTRONICS

## VIDEO CLARIFIER

**ELIMINATES ADVERSE EFFECTS OF VIDEO COPY-GUARDS!**



State-of-the-art circuitry restores original (master) quality to all video tapes. Allows for flawless viewing of all prerecorded video's whether rented, purchased or produced at home (even copy-protected tapes), for your personal home use. Unique auto Sync Boost feature eliminates horizontal instability and restores tapes to broadcast quality. Noise Reduction Circuit filters out the "snow" and other annoying interference. Compatible with all VCRs and T.V.s. Includes AC adapter.

CAT #VC-1 **\$59.95** each

## ULTRA-MINI FM RADIO

**WOW! SOUNDS GREAT!**

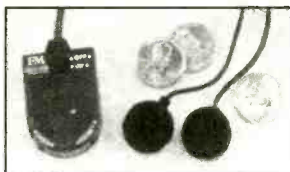

Fit an entire orchestra in the palm of your hand and still have room for the concert tickets with this Mini FM Radio that has an incredible sound. Features on/off button, seek button and reset button. Includes battery. If this isn't the world's smallest, it's close to it. But the sharp, clear sound that comes out will make you think you have a jam box. Black.

CAT #FM-1 **\$19.95** each

## 3 1/2 DIGIT PANEL METER

This meter has many useful applications such as Voltmeter, Thermometer, Db Meter, Watt Meter, Current Meter, Capacitance Meter, Lux Meter and LCR

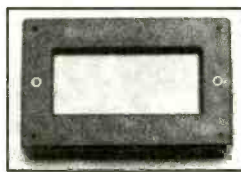

Meter. Features include: 200mV full scale input sensitivity, single 9VDC operation and decimal point selectable. In addition, it has 13mm figure height, automatic polarity indication, guaranteed zero reading for 0 volt input and high input impedance (>100M ohms). Specifications: Max input 199.9mV DC-Max. Display: 1999 counts (3-1/2 digits). Measuring method: Dual slope integration A-D converter system, plus many other features.

CAT #PM-1 **\$9.95** each

## STEPPER MOTOR CONTROLLER KIT

This kit allows you to adjust the speed and direction of a stepper motor. You can move the motor in one step increments or rotate it at a constant speed. There are a set of visual indicators that show the sequence of motor. Includes stepper motor, pc board, parts and instructions.

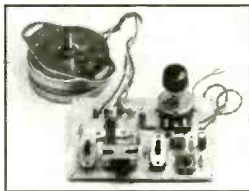

(12Vdc power source not included)

CAT #SMK-1 **\$25.00** each

## LASER POINTER

### 5mW LASER POINTER!

Make a point with your laser pointer. Pointers are the most effective way to demonstrate your drawings, schematics, presentation, and charts. Just press and point! The beam shoots out across the room and puts a red dot on the wall up to 350 feet away. Operates on 2AAA batteries (included). wt 2.3oz, wavelength 670nm/5mW output. Measures: 5" diameter x 5.75" L



CAT #LP-1 **\$39.99** each

## TALKING MEMO RECORDER

### TALKING MEMO RECORDER / KEY CHAIN

Records and plays messages up to 16 seconds (i.e. parking spaces, things to do, etc.) 16 seconds is a long time to dictate! Measures 3" x 1.95". Battery operated (included).

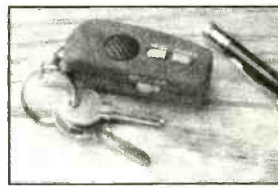

CAT #TM-1 **\$19.95** each

## FM WIRELESS MIKE KIT

### POWERFUL

2 stage, wireless mike kit transmits over .5 mile (up to 1 Km in the open) Tunable to the upper part of FM broadcast band. Circuit does require the ability to "tweak" RF circuits by stretching or compressing coils. With mike and 9V battery clip. Operates from 6-12V DC. 9.75" x .625" x .5" WT .06



CAT #FM-39 **\$10.95** each

## 9V DC FM TRANSMITTER KIT

### POWERFUL

FM transmitter. Transmits over 100 meters in building and over 500 meters outside using .25 or 5 wavelength of wire. Transmits to the upper part of FM broadcast band (100-108MHz) Circuit requires the ability to "tweak" RF circuits. Operates on 9V DC. 1.75" x .75" x .375" WT .05



CAT #FM-18 **\$9.95** each

## CAMCORDER VIDEO TAPES

### HI-8 120 MINUTE VIDEO CASSETTE TAPES (used)

They were recorded on once and played only a few times. Made by a major brand name manufacturer. Professional series metal tapes. Includes plastic jewel box.



NOTE: Other tapes available  
CAT #CCT-1 **\$3.00** each  
10 or more - **2.80** each

## EMERGENCY LIGHT

### THE AMAZING EMERGENCY LIGHT!

Never ever needs batteries! This waterproof unit is powered by pumping the handle-this action moves a flywheel which activates a dynamo. The dynamo produces a DC voltage and current that powers the light. Great for the car, home and boat. Never be without a light when the power goes out due to earthquakes, floods or other disasters. Operates when completely submerged in water. The dynamo can be stripped out for experimentation.



CAT # EL-1 **\$9.95** each

## TELEPHONE TRANSMITTER KIT

### JUST LIFT THE HANDSET!

Phone line powered and activated when handset is lifted. Uses phone wires for antenna. Transmits over short distance (100ft) to the lower part of FM broadcast band (90-95MHz). Circuit does not require the ability to "tweak" RF circuits. WT .06

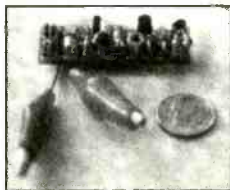

CAT #FM-16 **\$9.95** each

## STROBE KIT

This kit allows you to vary the rate of strobe flashes 60 to 120 flashes per minute. Operating voltage is adjustable depending on how you wire the kit. It will work on 4.5, 6 and 12 VDC. Includes pc board, parts and instructions.

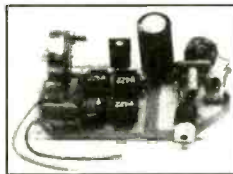

CAT #SLK-1 **\$7.50** each



Electronic Components, Supplies, Parts & Kits

645 Temple Avenue #7 ▲ Long Beach ▲ CA 90814

Local Phone Number (310) 434-5641

Hours: Monday - Friday 9 a.m. to 5 p.m. (Pacific Time)

California residence must include sales tax by county: 7.25 or 7.5 or 7.75 or 8.25 or 8.5  
Check, Money Order, VISA or MasterCard.  
Shipping in USA > \$4.00  
NO C.O.D.S. - Do not send cash.

PLEASE NOTE...We Are Not Responsible For Printing Errors. Quantities Are Limited. Prices Are Subject to Change Without Notice. Some Pictures May Vary From the Actual Item. Store Prices May Vary from Catalog Prices. Quantity Pricing is Subject to Freight Considerations

**CALL TOLL FREE! 1-800-526-3717**

CIRCLE 280 ON FREE INFORMATION CARD

# ALL ELECTRONICS

C O R P O R A T I O N

QUALITY PARTS

FAST SHIPPING

DISCOUNT PRICING

CALL, WRITE, FAX  
or E-MAIL For A  
**Free 64 Page**  
CATALOG.  
Outside the U.S.A.  
send \$2.00 postage.

## PHOTOVOLTAIC DETECTOR

Miniature silicon solar cell converts light impulses directly into electrical charges. Unlike a conventional photo diode or transistor, it generates its own power and does not require any external bias. Generates 0.4 vdc in moderate light. Silicon cell is mounted on a 0.31" x 0.23" x 0.07" thick plastic carrier and has pc leads on 0.2" centers. Large quantity available.

CAT # PVD-2

**75¢** 10 for \$6.50 • 100 for \$50.00

## Great Price! 800 MA UNIVERSAL WALL ADAPTOR

Multi-voltage power source eliminates the use of batteries in many electronic products. This handy device has 6 voltage settings between 3 and 12 Vdc. Universal power plugs fit almost every product. Polarity switch. UL and CSA listed.



**\$9.50** each

CAT # MOA-800

## "CLAM SHELL" CELLULAR CONTROL HEAD MOUNTING KIT

The "Clam Shell" kit is designed for mounting a cellular phone control head in a vehicle. It will work well for mounting many kinds of communications or audio equipment in cars or elsewhere. Made of heavy-gauge steel, featuring a full 180 degree tilt, a pre-drilled top plate with threaded holes that fit a majority of cellular control heads, it includes complete mounting hardware.



**\$2.50** each

CAT # CMT-2

## RECHARGEABLE BATTERY 12 VOLTS 9 A/H

Rechargeable lead acid battery. Prepped for use in a product which hasn't yet come to market. They are 5.9" x 2.55" x 4.42" high and have a strip of foam padding stuck to one side. They have standard 1/4" quick-connect/ solder terminals. Weight: 8 lbs.



CAT # GC-129

**\$28.50** each

8 for \$208.00

## OFFICE IN A BOX (tm)

Ora Electronics # XL-88

'Office in a Box' is a programmable device that enables you to answer your phone with up to eight programmable messages. Up to 32 seconds of recorded messages are stored in D-RAM. Eight pushbuttons allow you to select the playback message. This same technology might be adapted to Ham applications where call signs or other messages might need to be repeated. Includes control station, wall adaptor and ni-cad battery for memory back-up.

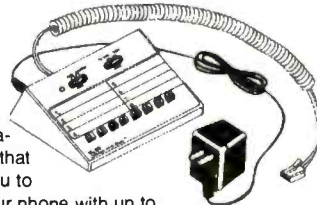

**\$9.50** each

CAT # XL-88

## SUB-MINIATURE SNAP ACTION SWITCH

CHERRY DG1C-BJ07 S.P.D.T. Body size: 0.51" long X 0.255" high X 0.255" wide. Lever with ridged end simulates roller action. Rated 3 amps @ 125 Vac, 2 amps @ 30 Vdc. PC pins on 0.2" centers. Large quantity available.



CAT # SMS-133

**2 for \$1.00**

100 for \$45.00  
1000 for \$350.00

## "HI-8" VIDEO CASSETTE (USED)

SONY HI-8

Top quality, metal particle 120 minute video cassettes. Used for a short time, then bulk-erased. Each cassette has its own plastic storage box. Satisfaction Guaranteed.

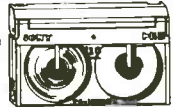

**\$3.00** each

CAT # VCU-8

10 for \$28.00 • 100 for \$250.00

## PHOTO RESISTOR

Silonex # NSL 4582

Cadmium Sulfide photoconductive cell. 22 ohms in bright light. 2 meg ohms dark. Plastic encapsulated. 0.29" x 0.26" x 0.07". 1.5" long wire leads.

CAT # PRE-12 **75¢**

10 for \$6.00 • 100 for \$50.00

## RANGE 20 METERS (65.6 FEET) INDOOR/OUTDOOR PHOTOELECTRIC SWITCH

SICK Optex # WS/WE260-M230

Invisible infrared beam and switch is useful for a variety of security, safety and sensing applications such as perimeter alarms, electric gate or garage door controls or conveyor line sensing. Modulated beam covers a 20 meter distance even with poor visibility. IP-66 enclosure rating makes it dust proof and splash resistant, suitable for most outdoor conditions. Light/dark switching selector. Sensitivity adjustment control. LED power and sense indicators. Two position cable entry gland (90 deg. apart) accepts 1/2" threaded conduit and a variety of wire sizes. Glass fiber-reinforced plastic housings are 3.05" x 2.5" x 1". Supply voltage: 22-240 Vac. Solid State Output: 0.5 amp (must have load to operate). Includes mounting brackets and hardware. UL and CSA listed.

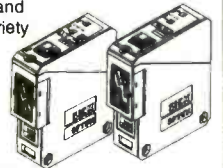

CAT # PES-4

**\$40.00** each

ORDER TOLL FREE

**1-800-826-5432**

MAIL ORDERS TO:  
ALL ELECTRONICS CORP.  
P.O. BOX 567  
VAN NUYS, CA 91408-0567

FAX (818) 781-2653 • INFO (818) 904-0524  
<http://www.allcorp.com/>  
E-MAIL [allcorp@allcorp.com](mailto:allcorp@allcorp.com)

NO MINIMUM ORDER • All Orders Can Be Charged to Visa, Mastercard, American Express or Discover • Checks and Money Orders Accepted by Mail • Orders Delivered in the State of California must include California State Sales Tax • NO C.O.D. • Shipping and Handling \$5.00 for the 48 Continental United States - ALL OTHERS including Alaska, Hawaii, P.R. and Canada Must Pay Full Shipping • Quantities Limited • Prices Subject to change without notice.

**MANUFACTURERS - We Purchase EXCESS INVENTORIES... Call, Write, E-MAIL or Fax YOUR LIST.**

CIRCLE 214 ON FREE INFORMATION CARD

[www.americanradiohistory.com](http://www.americanradiohistory.com)

# NEW SENSOR CORPORATION

20 COOPER SQUARE • NEW YORK, NY 10003  
(212) 529-0466 • (800) 633-5477 • FAX (212) 529-0486

## USA MILITARY JAN TUBES *NEW*, ORIGINALLY BOXED, AVAILABLE IMMEDIATELY

TUBE NUMBER	1 PC.	10 PCS.	25 PCS.	50 PCS.	100 PCS.	500 PCS.	1000 PCS.
0A3 JAN SYLVANIA	\$ 1.15	\$ .90	\$ .75	\$ .65	\$ .55	\$ .45	\$ .40
0C3W JAN RAYTHEON	3.65	2.90	2.30	1.90	1.60	1.30	1.20
5Y3WGTA JAN PHILIPS	4.90	3.90	3.40	2.90	2.60		
6AK6 JAN GE	.85	.80	.70	.60	.50	.40	.35
6AN5WA JAN PHILIPS	2.25	1.90	1.60	1.30	1.10	.90	.80
6AN8A JAN PHILIPS	5.90	4.70	4.20	3.80	3.15	2.60	2.30
6AS7GA JAN GE	6.15	4.90	3.50	2.90	2.60	2.40	2.30
<i>NEW</i> 6AU6WC JAN PHILIPS	2.75	1.95	1.50	1.15	.90	.80	.75
6AW8 JAN	2.20	1.80	1.50	1.20	.80	.70	.60
6BJ7 JAN	2.00	1.60	1.40	1.20	1.00	.90	.80
6BL8 JAN SYLVANIA	1.65	1.30	1.10	.80	.65	.50	.45
6BQ7A JAN GE	2.00	1.60	1.35	1.15	.95	.80	.70
6C4WA JAN PHILIPS	2.00	1.60	1.35	1.15	.95	.80	.70
6CX8 JAN GE	3.15	2.50	2.00	1.70	1.30	1.20	1.10
6DJ8 JAN PHILIPS	3.65	2.90	2.30	1.60	1.40		
6EA8 JAN PHILIPS	2.00	1.60	1.35	1.15	.95	.80	.70
6H6 JAN GE	.65	.50	.40	.30	.25	.20	.15
6J5WGT JAN PHILIPS	4.40	3.50	2.60	2.10	1.80		
6K7 JAN GE	.85	.80	.70	.60	.50	.40	.35
6L6WGB JAN PHILIPS	13.90	13.30	12.80	12.30	11.80	11.50	10.90
6L6GC JAN PHILIPS	21.50	16.90	16.20	15.40	14.90		
6SJ7 JAN GE METAL	1.40	1.15	.95	.85	.75		
6SL7WGT JAN PHILIPS	5.90	5.50	4.90	4.40	3.90		
6SN7WGTA JAN PHILIPS	7.40	5.90	5.40	4.90	4.60		
6SQ7 JAN GE	3.15	2.50	2.00	1.50	1.20	1.15	1.10
6U8A JAN PHILIPS	2.00	1.60	1.35	1.15	.95	.80	.70
6V6GT JAN GE (GLASS)	12.40	9.90	9.50	8.80	8.40		
6X5WGT JAN PHILIPS	1.90	1.50	1.35	1.20	1.05	1.00	.95
6Y6GT JAN RAYTHEON	2.25	1.90	1.60	1.30	1.10	.90	.80
12AT7WC JAN GE	6.15	4.90	4.40	3.90	3.50		
<i>NEW</i> 12AT7WC JAN PHILIPS	4.90	3.90	3.20	2.75	2.30	1.95	1.80
12AU6 JAN GE	1.90	1.50	1.25	1.00	.90	.80	.70
12AX7WA JAN GE	9.65	7.70	6.50	5.90	5.40	4.90	4.50
12AX7WA JAN PHILIPS	9.65	7.70	6.50	5.90	5.40	4.90	4.50
12SG7 JAN RCA	1.00	.80	.70	.60	.50	.40	.35
12SH7 JAN GE	1.00	.80	.70	.60	.50	.40	.35
12SJ7 JAN	1.25	1.00	.90	.80	.70	.60	.55
12SL7JAN GE	1.75	1.45	1.25	1.10	1.00		
5750 JAN GE	1.00	.80	.70	.60	.50	.40	.35
5751 JAN GE	4.50	4.30	4.10	3.80	3.50		
5814A JAN PHILIPS	3.75	3.00	2.75	2.50	2.20		
6072A JanGE - MIL 12AY7	8.90	7.70	6.50	5.90	5.40	4.90	4.50

MASTER CARD/VISA ACCEPTED • MINIMUM ORDER \$ 100.00 • ALL ORDERS SHIPPED F.O.B. N.Y.C.



**USA MILITARY JAN TUBES** *NEW*, ORIGINALLY BOXED, AVAILABLE IMMEDIATELY

TUBE NUMBER	1 PC.	10 PCS.	25 PCS.	50 PCS.	100 PCS.	500 PCS.	1000 PCS.
6080WC JAN GE	\$ 6.15	\$ 4.90	\$ 4.40	\$ 3.90	\$ 3.40	\$ 2.90	\$ 2.75
6188 JAN PHIL - MIL 6SL7	11.15	8.90	7.90	6.40	5.90	5.60	5.30
6189W JAN PHILIPS	3.75	3.00	2.75	2.50	2.20	2.00	1.90
<i>NEW</i> 6550A JAN GE	39.75	31.80	<b>PRISTINE 1985 MILITARY STOCKS</b>				
6922 JAN PHILIPS	3.90	3.20	2.50	1.90	1.50	1.20	.95
83 JAN GTE	8.90	7.90	6.90	6.40	5.90		
829B JAN CENTRON	8.90	7.90	6.90	6.40	5.90	5.80	5.70
7119 JAN AMPEREX	8.65	6.90	5.90	5.40	4.90		
7581A JAN PHILIPS	19.50	18.00	17.25	16.50	15.75		

**Other odd tubes**

0A5 JAN CETRON	\$ .290	5702 WB JAN RAYTHEON	\$ .30	6844A JAN	\$ 6.90
14R7 JAN SYLVANIA	.40	5703WB JAN RAYTHEON	.30	6888 PHILIPS	.80
154-0517-05 TEKTR	90.00	5719 JAN PHILIPS	.80	6AG7 JAN GE	.50
154-0672-05 TEKTR	35.00	5744WB JAN RAYTHEON	.30	6BC5/6CE5 PHILIPS	.60
1X2C JAN PHIL/GE	.40	5784WB JAN RAYTHEON	.30	6C5 JAN GE	1.00
2B22 JAN CETRON	3.70	5787WA JAN RAYTHEON	.30	6CB6 JAN GE	.60
3B22 JAN RAYTHEON	9.50	5840 JAN PHILIPS	.40	7F7 JAN SYLVANIA	2.50
2C42 JAN GE	9.00	5842Q JAN RAYTHEON	3.00	7F8W JAN GTE	1.20
2G21 JAN RAYTHEON	2.90	5961 JAN NATIONAL	6.00	884 JAN SYLVANIA	1.70
2K45 RAYTHEON	17.00	5A6 JAN TUNG/RAYTHEON	.90	CAGX3JP1 JAN	19.00
3B24WB JAN CETRON	5.00	6082WB JAN RAYTHEON	4.00	CK7995 JAN RAYTHEON	.60
3E29 JAN CETRON	5.00	6088 JAN RAYTHEON	.40	DOD 001 JAN RAYTHEON	4.00
5642 JAN PHILIPS	.75	6186W JAN PHILIPS	1.50	MA-6230 MAGNETRON	35.00
5656 JAN RAYTHEON	3.90	6206 JAN RAYTHEON	2.70	NL918/5560 NATL	4.00
5670W JAN GE	.60	6264A JAN RCA	1.00		
5676 JAN RAYTHEON	.40	6418 JAN RAYTHEON	.70		

**LIMITED SUPER SPECIALS**

**6L6WGB JAN PHILIPS = MILITARY 5881.** This warm sounding tube has a unique sound in between that of 6L6GC and EL34. It was used in the early Fender Bassman amps.

**10 pcs. - \$9.90, 25 pcs. - \$8.90, 50 pcs. - \$8.20, 100 pcs. - \$7.60, 500 pcs. - \$7.20, 1000 pcs. - \$6.90**

**12AX7A CHINA** In individually marked boxes.

**100 pcs. - \$1.78 ea. 1000 pcs. - \$1.49 ea.**

**KT88 TESLA** Fabulous new KT88 for hi fi lovers who demand the very best.

**10 pcs. - \$30.90 ea. 26 pcs. - \$29.50 ea. 50 pcs. - \$28.90 ea. (Free matching)**

**KT90 EI** We now have stocks of the famous EI KT90.

**10 pcs. - \$25.80 ea. 26 pcs. - \$23.90 ea. 50 pcs. - \$22.50 ea. 100 pcs. - \$21.00 ea. (Free matching)**

**MASTER CARD/VISA ACCEPTED • MINIMUM ORDER \$100.00 • ALL ORDERS SHIPPED F.O.B. N.Y.C.**

# BRIGAR ELECTRONICS

7-9 ALICE ST.

BINGHAMTON, NY 13904



PHONE (607) 723-3111  
 FAX (607) 723-5202  
 E-MAIL BRIGAR2@aol.com

**\$30.00 MIN ORDER**

SEND FOR FREE CATALOGUE

SERVING: \*INDUSTRY \*SCHOOLS \*HOBBYISTS \*EXPERIMENTERS \*CONSUMERS

OPEN: MONDAY THRU FRIDAY 7:30 AM TO 4:30 PM, SATURDAY 7:30 AM TO NOON



CREDIT CARD DISCOUNT  
 \$ 0.00 - \$99.99 ... NET  
 \$100.00 - 249.99 Less 10%  
 \$250.00 - 499.99 Less 15%  
 \$500.00 - 999.99 Less 20%

**Answering Machine Code-a-phone #1750**  
 FEATURES: \*One touch play back \*Ring delay(1,2,3,4) \*Auto out going message check \*Variable out going message \*Built in cassette \*No call disconnect \*Voice-activated recording \*Led message display \*Fast forward,rewind, pause & rr (Removed from service good cond.)  
 Original COST \$179.00  
 COMMERCIAL Quality

**SALE PRICE \$7.95**



**ULTRASONIC LIGHT SWITCH**  
 Motion Sensing Automatic SWITCH  
 Replaces existing wall switch - operates from 120vac power. 750W max. load. Great for home alarm systems or controlling lights & small appliances. Adjustable time & sensitivity, on-off switch - led trip indicator - Color: White  
 Size: 5"w x 5"h x 1-3/8" d  
 Energy Savings 30 to 60%

**PRICE \$12.95 EA.  
 5 FOR \$60.00**

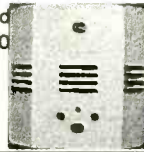

**HI VOLUME FAN - 115 VAC  
 NIDEC-TORIN TA600S**  
 .250/.20 AMP 3200 RPM  
 IMPEDANCE PROTECTED.  
 50/60 HZ - MODEL # A32060-10  
 SIZE: 6.25"DIA. X 1 1/2"THICK  
 BRAND NEW FACTORY BOXED.

**PRICE... \$14.95 EA.  
 5 for \$60.00**



**3M STATIC CONTROL FLOOR & TABLE MATS**  
 8200 series - 2 ft. X 5 ft mat  
 3 LAYER CONSTRUCTION  
 COLOR BROWN  
**SPECIAL ... \$25.00**

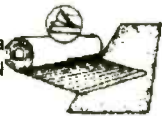

**ROHM # SLR47VR3F**  
 RED LED T 1-3/4  
**ROHM**  
 5MM DIFFUSED LED  
 100 PCS. @ 10¢ EA.  
 500 PCS. @ 7¢ EA.  
 1000 PCS. @ 5¢ EA.



**STEPPING MOTOR - AIRPAX**  
 100 STEPS/REV. \* 3.6 Step angle  
 \*bi polar wound-bi-directional \*2 PH  
 \*Torque 75 oz/in  
 \*SIZE: 1.5"SQ X 1 3/8" H  
 \*3.2VDC \*6.8AMP \$2.25



**COMPUTER PRODUCTS**  
 POWER PRODUCTS DIVISION  
**# HE381**  
 Power Products  
 Linear power supply module  
 Input: 115VAC 50/60 271 ma  
 OUTPUT: 5VDC 5000 ma  
**PRICE .. \$20.00**



**CMOS EPROM #NMC27C256Q-200**  
 28 PIN DIP 256K (32 X 8)  
 SPEED 200 NS  
 LIST PRICE \$5.00  
**BRIGAR PRICE.. \$1.75**



**CURTIS INDUSTRIES #F1200AA20**  
 10 AMP 250VAC - 20AMP 115VAC  
 50/60HZ-size: 2"w x 2 1/2"l x 1 1/2"h  
 .250" QUICK Connect  
 Brand new factory Boxed  
**BRIGAR SALE PRICE ..... \$3.50**

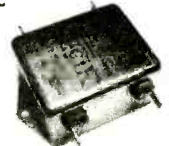

**TELEDYNE SOLID STATE RELAY**  
**PART # 615-8500**  
 CONTROL VOLTS: 3-32V  
 RATED: 10AMP @ 250VA  
 50/60HZ -  
 OPTO ISOLATED - SPST  
 Connection: screw or quick Connects  
**PRICE... 1 - 99 PCS. 100 PCS - UP**  
 \$ 10.95 \$ 9.95



**MEMOREX AUDIO PATCH CABLE**  
 6 FT. RCA MALE TO RCA MALE  
 BLACK CABLE MOLDED ENDS.-  
 MONO CABLE - BLISTER PACKED  
 FOR DISPLAY. **SALE PRICE.. \$1.00**



**INTEL # P 8051AH**  
 8 - BIT CMOS CPU, 256 BYTES RAM  
 12 MHz - 40 PIN  
 PRICE.... \$2.50 EA.  
 100 PCS. & UP \$1.75 EA.



**ASTROSYN MINIANGLE Stepper Motor**  
**#23LQ-C202-01H**  
 \*144 STEPS \*30 oz in. Hold torque  
 \*BI POLAR - 2 PHASE  
 \*4 WIRE \*1.9 Vdc/PHASE  
 \* 0.75 AMP/PHASE  
 \*WEIGHT 3/4 LB  
 \* SIZE: 1-1/2"H X 2-1/4"DIA  
 \*Mounting plate: 2-1/4"sq.  
**SPECIAL SALE.. \$12.95**



**5 - 9W DC/DC CONVERTERS**  
 \*PC-MOUNTABLE \* 500 V Isolation  
 \*PI INPUT FILTER \* Unregulated  
 SHORT CIRCUIT PROTECTED  
 HIGH EFFICIENCY - 75%  
 OUTPUT: ±12V ±375 MA  
 INPUT: 5VDC  
 REGULATED LINE: 1.2% LOAD 8%  
 SIZE:  
 2" X 2" X .4"THICK



**PRICE... \$6.25 EA.**

**GRAY FLAT RIBBON CABLE**  
**#YP3301 50 COND. 28 AWG (7/36)**  
 .010" Thick pvc insul. 300V - 105 °c  
 awm style 2651 mil-c-49055/1-13a  
 ul approved .050 Cond. Spacing  
 black polarity stripe. Will terminate to any standard idc connector -2.5" Wide  
**Brand New Factory Boxed.**  
 ORIGINAL PRICE \$360.00  
 300 FT. REEL ... \$69.00



# S K Y V I S I O N<sup>®</sup>

1046 Frontier Drive Fergus Falls, MN 56537 Fax: 218-739-4879

## DIGITAL is the Future Introducing...

### "The New Kid on The Block"



18" DIGITAL DISH

We've been hearing a lot lately about the new little dishes. The DISH<sup>SM</sup> Network System is the latest, and he arrived as a shining star. He is small, attractive and the latest in technology, but what really sets him apart is the programming he delivers to your Television screen.



The DISH<sup>SM</sup> Network is chock full of the most popular programming at prices much lower than the competition. Call us now for more information. Digital just may be in your future.

The  
Dish is Small  
The  
Programming  
BIG

Beat The Rush Call Now  
**800-500-9264**  
Special Digital Hotline

30%-60%  
Savings!  
Compare to  
Other 18" Dish  
Programming!

## If you have one of these...

### "Keep it Running Strong" With a Discount Buyer's Guide

If you are the owner of a C/Ku-band Full View Satellite System, we know you'll want to keep it up and running strong. The Skyvision Discount Buyer's Guide will give you advice and products to get the job done right.

#### You Will Find a Wide Selection of:

- Complete Systems
- Advanced Upgrades
- Parts & Accessories
- Tune-Up Tools & Advice
- Technical Tips Galore
- Discount *Skypac*<sup>SM</sup> Programming

For Your Free Issue Call Now

**800-334-6455**

Need a repair item Fast??

"We'll Get It Out Today"

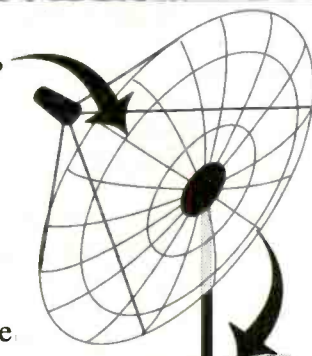

The most complete  
Big Dish Satellite  
Discount Buyer's Guide!  
Get your FREE copy now

June 1996, Electronics Now

# EARN MORE MONEY!

## Be an FCC LICENSED ELECTRONIC TECHNICIAN!



**Earn up to \$60 an hour and more!**

Learn at home in spare time. No previous experience needed!

No costly school. No commuting to class. The Original Home-Study course prepares you for the "FCC Commercial Radiotelephone License." This valuable license is your professional "ticket" to thousands of exciting jobs in Communications, Radio-TV, Microwave, Maritime, Radar, Avionics and more...even start your own business! You don't need a college degree to qualify, but you do need an FCC License.

**No Need to Quit Your Job or Go To School** This proven course is easy, fast and low cost! **GUARANTEED PASS**—You get your FCC License or money refunded. **Send for FREE facts now. MAIL COUPON TODAY!**

Or, Call 1-800-932-4268 Ext. 210

### COMMAND PRODUCTIONS

FCC LICENSE TRAINING, Dept. 210  
P.O. Box 2824, San Francisco, CA 94126  
Please rush FREE details immediately!

NAME \_\_\_\_\_  
ADDRESS \_\_\_\_\_  
CITY \_\_\_\_\_ STATE \_\_\_\_\_ ZIP \_\_\_\_\_

## TOP SECRET

### CONSUMERTRONICS

2011 Crescent Dr., P.O. Drawer 537  
Alamogordo, NM 88310

--- Please order by Mail or Fax only ---  
Fax: (505) 434-0234, 439-1776 (orders only; if you get voice, enter #11 any time), 24-hr

Customer Service & Tech Dept: (505) 439-8551 (8AM-6PM MST, Mon-Sat)  
Relates directly to your order or prospective order.

Web Page: Visit our popular home page - tell your friends: <http://users.aol.com/wizguru/hl-tech.html>

10% Off on orders \$100+ 15% Off over \$200+ Add \$5 total SH (US, Canada). All items in stock. Postal M.O. is fastest. VISA, MC CC OK. COD (\$49.999), add \$8. New Catalog (200+ offers) \$2 w/ order, \$5 w/o (no CC), \$24/foreign. HQ dealers.

Since 1971, As seen on CBS "60 Minutes," Forbes, etc. By John Williams - former Lockheed Senior Engineer, NMSU CS Professor, DOD Electronic Weapons Engineer, NIH Health Physicist. Sold for educational purposes only.

Wanted: 5 MAC files, PC486 (or better), peripherals, new surplus electronic parts, test equipment - buy, trade.

\*All software supports all IBM-PC systems

### Off-the-Shelf HARDWARE

Van Eck Systems \* Data Card Reader/Writers \* ATM3 \* RF/EM/UV Wave Radar/Ultrasonic/IR/Light/Sound Detectors/Receivers/Amplifiers/Jammers/Blasters \* Security/Surveillance \* Neurophone/Rife/Heteronyms/Resonant Crystal Radionics \* EM Lab/Weaponry/Countermeasures \* Voice Disguisers \* ESS Infinity Devices \* Lineman's Handsets \* Bug/Tap Detector/Blaster/Phone Color Boxes \* DTMF Decoders \* Bumper Beeper/Child Finder \* Panic Button \* Car Jack/Kidnap Folier \* Hidden Presence Detectors \* Hearing Aids \* Shriek Module \* TENS \* Subliminal Mixer/Amp \* Vortex Generator \* 6th Sense Communicator \* Noise Cancel. System \* Electronic Dowsers \* Levitator - many more! See our New Catalog!

### SPECIAL PROJECTS

We design/build/obtain/repair/modify/maintain/consult on any device/system/process/project - electronic/computer/mechanical/optical (ex: phone/auto/security/radionic/lab/energy/UV/EM/RF/radar/ultrasonic/IR/UV/countermeasures) for business/personal/invention needs. Describe & include \$30 pre-engineering fee (no obligation). Time & cost estimates 7-10 days. Confidentiality guaranteed.

### 1+GBYTE DATABASE

Let us search our massive 1.03 GigaByte Hi-Tech Survival Database for you. Virtually every major Hi-Tech Survival topic covered in depth. Some private files. See New Catalog.

### CELLPHONE MODS

See our Catalog for our infamous cellphone modification guide (\$69) - detailed, comprehensive, covers all makes - 10 times more info than competitor's "guide". (Do Special Projects above to get up-to-date hardware/software).

### VOICE MAIL HACKING

How Voice Mail Box (VMB) systems are used and the specific ways they are hacked, includes ASPEN, MESSAGE CENTER, BIX, GENESIS, EZ, SYDNEY, PHONE MAIL, AUDIX, CINDY, CENTAGRAM, SPERRY LINK, RSVP, etc. Absolutely required for all users, sysops and security personnel! \$29.

### PBX HACKING

1,000s of PBXs are hacked to the tune of \$ Billions/yr! While "VOICE MAIL HACKING" details how VMBs are hacked for "pump" and profit - including VMS methods for hacking PBXs themselves - "PBX HACKING" addresses ALL issues relating to PBX hacking, including countermeasures! Can your business or agency afford a \$90,000 phone fraud loss (the average loss due to hacked PBXs)? As described in Forbes Magazine. \$29

### PHREAKING CALLER ID & ANI

Details on how they work and dozens of effective ways of defeating Caller ID. Also describes Caller ID, Orange, Beige, Cheese and CF Boxes, ESS, SS7, E-911, various CLASS services, CNA, NON PUB DA, CAMA, DMR, 800-ECR, Diverters, Extenders, Centrax - more. \$29.

### Beyond PHONE COLOR BOXES

Dozens phone color boxes described - many circuits. Plus Call Forwarding, Conferencing, Phreak History, Glossary, Diverters, Extenders, Loops, REMOBS, Bridging Heads & Cans, Optocom, 3rd Party and many other non-box methods - more. \$39.

### HACKING ANSWERING MACHINES

How answering machines are hacked to listen to - even erase - messages, and to convert them into mini-VMBs. And countermeasures - protect yourself from snoops, stalkers, burglars and pranksters! \$29.

### CREDIT CARD SCAMS

Cardholders, merchants, banks suffer \$ Billions in losses annually because of credit card fraud. Describes every known means of credit card fraud and scams. Protect yourself! \$29.

### AUTOMATIC TELLER MACHINES/ATM crimes, abuses, vulnerabilities and details exposed! 100+ methods detailed, include: Physical, Reg. E, cipher, PIN compromise, card counterfeiting, magnetic stripe, false front, TEMPEST, Van Eck, tapping, spoofing, inside job, super-cool, vibration, pulse, high voltage - others. Case histories, law, countermeasures, detailed security checklist, labeled internal photos, figures. ATMs contain up to \$250,000 in cash! Recent \$350,000 ATM crime spree still unsolved! \$39.

### CONS. SCAMS & SWINDLES

Cons & scams and related swindles fleece Americans of \$100+ Billion per year! The most comprehensive survival manual on cons & scams of all kinds - from the classic to hi-tech. Details on 100s and many variations. And countermeasures. Protect yourself! \$39.

### COMPUTER PHREAKING

Describes in detail how computers penetrate each other, and how VIRUSES, TROJAN HORSES, WORMS, etc. are implemented. Dozens of computer crime and abuse methods and countermeasures. Includes disk wipe with hacker tool files and utilities, and the legendary FLUSHOT+ protection system (Ed. Chalk, PC Magazine). BBS advice, password defeats, glossary - much more! Manual + Disks\* \$39.

### Beyond VAN ECK PHREAKING

Leaves dropping on TV and computer video signals using an ordinary TV described in detail. Includes security industry reports. Range up to 1 KM. Plans include both the Consumertronics and the original Top Secret Van Eck designs! \$29.

### The HACKER FILES

Compilation of 100s of the best articles written (in ASCII) by top hackers & phreakers. Covers every major topic in hackerdom! 3 HD Disks\* \$59.

### STOPPING POWER METERS

As reported on CBS "60 Minutes": How certain devices can slow down - even stop - without meters - while loads draw full power! Device simply plugs into one outlet and normal loads go into other outlets. It describes meter creep, overload droop, etc. Plans \$29. I.Q. MANUAL: External magnetic ways (applied to the meter itself) to slow down and stop wattour meters while drawing full loads. Plans. \$29. KW-HR METERS: How wattour meters work, calibration, error modes (many), ANSI Standards, etc. Demand and Polyphase Meters. Experimental results to slow and stop meters by others. \$25. Any 2. \$41. \$69.

### UNDER ATTACK!

Electromagnetic Interference and Electronic Weapon Attacks cause: Cancer, birth defects, and profound psychological, neurological, cardiovascular and immune system disorders! Destructive to people, animals, plants, equipment! Includes ACTUAL CASES OF EM ATTACKS (we investigated)! Includes how to verify and pinpoint EMI and electronic attack sources, and effective countermeasures. \$29. See also: EM and EMI: A tutorial and plans for powerful ELECTROMAGNETIC WEAPONS and LAB DEVICES. Optimum circuits, freqs, waveforms, duty cycles, intensities. Thorough. \$29. Both \$49.

### MIND CONTROL

Concern and war increases over EMI and ultrasonic mind (and body) control technologies - especially implants! Unfortunately, there is much more misinformation and disinformation published than facts. Some victims are controlled and exploited by arm-chair "experts" and so-called victims' assistance groups - one even demands the policing of the Internet to prevent and remove postings it doesn't approve of! \$39. Visit web page at: <http://users.aol.com/wizguru/mindcontrol.html>

### RADIONICS MANUAL

Exciting electrical, electronic, electromagnetic therapeutic, diagnostic & preventive devices (mostly experimental). History, descriptions, plans (dozens), availabilities of Radionics Devices from early to modern. World drugs cost \$100s, electricity costs pennies! \$29. HEAL YOURSELF! Plans for 3 major electronic therapeutic devices of types approved by FDA. \$19. Both \$39.

### HIGH VOLTAGE DEVICES

HV devices plans: Slon Gun, Vaser, Prod, Cane, Blister, Flasher, Zapper, Audio/RF/Radar Jammer, Fence Charger, Plasma & Van de Graaf Guns, Jacob's Ladder, Gulper Counter, Ozon Gun, Fish Stunner, Plant Stim., Kirlian, more! All plans for only \$29.

### STEALTH TECHNOLOGY

Police radar is fascinating! It also has error rates of 10-20%! Every known error mode - stealth method and material used to minimize radar reflections - tactic and strategy to fight unjust radar tickets (that cost you \$100s in insurance and risk cancellation) methods to detect and limit signals - fully described! \$29.

### SECRET & SURVIVAL RADIO

Optimum survival and security radio equipment, methods, freq allocations and voice/data scrambling/encoding. Includes small covert transmitters, telemetry, antenna options, remote monitoring, and control. Survival, surveillance, and ultrasonic, fiber-optic and infrared comm. 70+ circuit plans, tables. \$29.

### By an ORDER of the MAGNITUDE

The most comprehensive, hard-hitting, hi-tech survival book ever written! Topics include: electronics, computers, energy, weapons, concealment, revenge, alarms, etc. to survive today's dangerous world. We all face increasingly financially and physically brutal times! Field-expedient use of technology in various threat and conflict environments and scenarios. \$49.

### ROCKET'S RED GLARE

How to design and build solid-propellant amateur and survival rockets. Emphasis on formulation, manufacture, installation of propellants, motors, igniters, etc. Includes list of commonly available materials, and the design of launch pads and test beds and their electronics. \$29.

### FIREWORKS

How firecrackers (M-80s, blockbusters, cherry bombs), small rockets, volcanos, fountains, sparklers and safety fuses are made and colored. Simple, cheap, common ingredients. \$6. Both \$36.

# ELECTRONICS® MCM

**20<sup>th</sup>  
Anniversary  
1996**

**Readers Specials!**  
Save on select items for the workbench. Take advantage of these tremendous offers. Call today, time is limited!

To take advantage of these offers, you must supply this special price code:

**CODE: ENS24**

## Value and Selection From One source...

- Test Equipment from Tenma, Fluke, Hitachi, Leader, B+K
- Name Brand and Low Cost Generic Technician's Tools
- OEM and Generic TV/VCR repair parts
- Over 10,000 American and Original Japanese Semiconductors

MCM offers a full line of tools and test equipment engineered for the repair of computers, TVs, VCRs and more. In addition, you will find a wide variety of TV/VCR parts, passive components and semiconductors, over 25,000 items in all, stocked and ready to ship.

### Fluorescent Magnifying Lamp

3x magnifying lens and 22W bulb brings your small work into full view. Spring arm reaches up to 45° and clamps securely to edge of workbench.

**#21-935**  
Reg. \$72.50 **Sale \$52.50**

**SAVE  
28%**



**SAVE  
\$50**



### TENMA™ Universal Test System

Combines a triple output supply, full function analog/digital DMM, 1GHz frequency counter and 2MHz sweep function generator.

**#72-5085** Reg. \$549 **Sale \$499**

**SAVE  
30%**

### TENMA™ Digital Solder Station

Digital display accurately shows temperature and setpoint. 320~900°F adjustment and grounded tip make this ideal for most soldering applications.

**#21-1590**  
Reg. \$119

**Sale \$83.00**



**FREE  
Catalog**



Prices effective until  
July 6, 1996

Call Today For your FREE catalog.

**1-800-543-4330**

Hours: M-F 7 a.m.-9 p.m., Sat. 9 a.m.-6 p.m., EST.



**MCM ELECTRONICS®**

850 CONGRESS PARK DR.  
CENTERVILLE, OH 45459-4072

A PREMIER Company

Fast delivery from distribution centers near Reno, NV and Dayton, OH!

**RCA/36 Premier Distributor**

Authorized  
**Panasonic**  
**Quasar/Technics**  
Original Parts  
Distributor

**CODE: ENS24**

CIRCLE 327 ON FREE INFORMATION CARD

# BLOWOUT! TIMELINE INC. BLOWOUT!

Over 9 years and 24,000 customers and still growing

## LIQUID CRYSTAL DISPLAYS

160 x 128 dot LCD with built-in controller (T6963C)  
20 character x 16 line **\$79.00** or 2 for **\$149.00**

Mfr.: Toshiba TLX-1013-EO.  
Unit is EL back-lit. Dim: 5 1/8" L x 4 1/8" H.  
The built-in controller allows you to do text and graphics.

240x64 dot LCD with built-in controller. **\$79.00**  
Mfr.: AND 4021ST-EO. Unit is EL back-lit. or 2 for **\$149.00**

## Alphanumeric—parallel interface

16x1.....3 for \$25.00	20x2.....\$12.00	40x1.....\$8.00
16x1 (lg. char.)...\$12.00	20x4.....\$25.00	40x2.....2 for \$25.00
16x2.....\$8.00	20x4 (lg. char.)...\$25.00	40x4.....\$25.00
16x2 (lg. char.)...\$12.00	24x2.....\$12.00	4x2.....\$5.00
16x4.....\$15.00	32x4.....\$10.00	

5V power required • Built-in C-MOS LCD driver & controller • Easy \*microprocessor interface • 98 ASCII character generator • Certain modules are backlit, call for more info.

## Graphics and alphanumeric—serial interface

size	Mfr.	price	size	Mfr.	price
640x480 (backlit)	Epson	\$35.00	480x128	Hitachi	\$15.00
640x400 (backlit)	Panasonic	\$25.00	256x128	Epson	\$20.00
640x200	Toshiba	\$15.00	240x128 (backlit)	Optrex	\$20.00
480x128 (backlit)	ALPS	\$15.00	160x128	Optrex	\$15.00

## LASER PRODUCTS

HeNe Laser Head (10mW max. output) TEMOO, 15.5" long MFG: NEC **\$99.00**

Laser Power Supply (for HeNe tube) **\$89.00**

LASER SCANNER ASSEMBLY **\$29.00**

Assembly intended for a laser printer. Includes laser diode, polygon motor (6 sided) and misc. optics and lenses.

LASER DIODE (5mW) with collimator **\$20.00**

VISIBLE LASER DIODE: 5mw at 670nm **\$15.00**  
index guided. Threshold current 40 ma typical.

## POLYGON MOTOR UNIT & DRIVER

Ten-sided first surface mirror mounted on an armature that spins at 125 revolutions per second yielding a beam sweep rate of 1250 sweeps per second. The driver for the polygon unit requires 24 volts and plus and minus 12 volts to operate. There is also an f-theta lens in front of the polygon scanning mechanism with a three inch diameter. Great for optical experiments, etc. Very high quality units. (MFR: JAPAN ELECTRONICS)

**\$79.00**

## NETWORK

Proteon ProNet-4 Model p1347 Token Ring Board **\$79.00**

16 bit • 4 Mbps • IEEE 802.2 and 802.5 compatible • twisted pair • interoperable with IBM Token Ring network

## POS & BAR CODE

MAGNETIC CARD READER **\$25.00**

Includes: • 20 character dot matrix display with full alpha-numeric capability • keypad with full alpha-numeric entry • separate 7.5 VDC/0.5 Amp power supply • standard telephone interface extension cord • lithium battery and flat-cone speaker.

HP bar code wand (HBCS 2300).....\$35.00

## POWER SUPPLIES

73 WATT SWITCHING **\$15.00** or 2 @ **\$25.00**, (2) 4 pin power connectors attached

• 115/230 Volt, Dim: 8.5" L x 4.5" W x 2" H • Output: +5V @ 2-9.75 A, +12V @ 0-1.5 A, .5V @ 0-0.4 A, -12V @ 0-0.5 A

68 WATT SWITCHING **\$12.00** or 2 for **\$20.00**, 115/230 Volt, Dim: 5.5" L x 3.2" W x 1.7" H • Output: 5V @ 4 A, 12V @ 4 A

## MISCELLANEOUS

ADAPTEC 4070A (RL) OR 4000A (MFM) SCSI Controller, your choice **\$25.00**

IBM 370 option XT and AT emulation boards **\$35.00**

## MONITORS

### Non-Enclosed TTL

Comes with pinout. 12V at 1.4 Amp input • Horizontal frequency 15Khz. • Ability to do 40 and 80 column.

5 inch Amber **\$35.00**  
7 inch Amber **\$39.00**  
9 inch Amber or Green **\$29.95**

5" COLOR MONITOR **\$49.00**

- Flat Facplate • 320 x 200 Dot Resolution • CGA & Hercules Compatible
- 12 VDC Operation • 15.75 KHz Horiz. Freq. • 60 Hz Vert. Sync. Freq.
- Open Frame Construction • Standard Interface Connector
- Degaussing Coil included • Mfr. Samtron



## CHARGE COUPLED DEVICES



"The Spy In The Sky" **\$29.00**

MATRIX TYPE

Sony CCD Imager - designed for black and white composite video cameras. Picture elements: 384 (H) x 491 (V)  
Chip size 10.7 (H) x 9.3 (V) mm<sup>2</sup> • Unit cell size 23.0 (H) x 13.4 (V) um<sup>2</sup>.  
Ceramic 24 pin DIP package • Mfr: Sony, Part# 016AL

4096 element CCD **\$29.00**

1024 element CCD **\$15.00**

2048 element CCD **\$15.00** • 1728 element CCD **\$15.00**

LINEAR TYPE

## HACKER CORNER

### CELL SITE TRANSCEIVER **\$99.00**

These transceivers were designed for operation in an AMPS (Advanced Mobile Phone Service) cell site. The 20 MHz bandwidth of the transceiver allows it to operate on all 666 channels allocated. The transmit channels are 870.030-889.980 MHz with the receive channels 45 MHz below those frequencies. A digital synthesizer is utilized to generate the selected frequency. Each unit contains two independent receivers to demodulate voice and data with a Receive Signal Strength Indicator (RSSI) circuit to select the one with the best signal strength. The transmitter provides a 1.5 watt modulated signal to drive an external power amplifier. Channel selection is accomplished with a 10 bit binary input via a connector on the back panel. Other interface requirements for operation are 28 VDC (unregulated) and an 18.990 MHz reference frequency for the digital synthesizer. The units contain independent boards for receivers, exciter, synthesizer, tuneable front end, and interface assembly (which includes power supplies and voltage-controlled oscillator). Service manual, schematics and circuit descriptions included.

### Encased Black & White Composite CCD Camera with Adapter IR viewing to 1000 nm 7 1/2 L x 2 1/2 W x 1 1/2 H

Comes complete with CCD camera, mounting nut on bottom of casing, 12VDC power supply. Excellent low light capability, standard RCA NTSC video out. **\$89.00**  
Great for: entryway security/remote monitoring, video conferencing/desktop video conferencing **2 for \$159.00**

This miniature camera is perfect for multimedia computer applications as well as security and surveillance. NTSC output allows use with all popular video digitizing boards for Apple Macintosh and Microsoft video for Windows. Connects directly to any composite monitor or VCR with "video" input. Its razor-sharp wide-angle lens focuses from two inches to infinity and its state-of-the-art CCD technology accurately captures 16 level grayscale images for Quick Time movies and still pictures. Records at 30 frames per second and 260 lines resolution with excellent low light capability. Uses 12VDC (adapter supplied) and standard RCA cable.

### Portable Micro Terminal **\$99.00** or 2 for **\$149.00**

Flip up LCD display (9-16 VDC) • Can communicate with any computer having RS 232 port • Can communicate with another Microterminal • Use by itself as electronic notebook • Onboard microprocessor, data RAM (32K) and Video RAM (64K) • Complex built in diagnostics and set up capabilities. • Original intention for POS applications. • display size 40x16 (256 x 128 pixels). Dimensions: 6.3" W, 11" L, 2" H. (With LCD up height is 7.1")



### BAREBONES 286-12 COMPUTER **\$49.00** (2 FOR **\$79.00**)

Slimline desktop case, 100 watt supply, math co-processor support. On board IDE, & Floppy controllers. 2 COM ports and 1 parallel port with software setup. Supports up to 8 Megs using standard 30 PIN SIMMs. Internal room for (1) 3 1/2 inch IDE hard drive and (2) 3 1/2 inch floppies. Four 16 BIT ISA slots, accepts full length AT size cards. Keyboard can be set to no test at boot. Case size is 15.5"W x 16"D x 4"H.

(Motherboard can be purchased separately: **\$29.00** or 2 for **\$49.00**)

### CORNER CUBE **\$29.00** Solid Glass Retro-Reflector

Unit is a trihedral prism with three mutually perpendicular faces. It reflects incoming light rays precisely back in the direction they came from, regardless of the angle of the corner cube itself. It is thus self aligning. Made for a military weapons program. Can be used for laser based ranging (distance measuring), seismology, multipass interferometry, and many other optical experiments. Diameter: 66.5 mm Height: (face to point) 40.2 mm Flatness: 1/8 wave @ 632.8 nm

\*Minimum Order: \$20.00. Minimum shipping and handling charge \$5.00. We accept cashiers checks, MC or VISA. No personal checks or COD's. CA residents add 8.25% sales tax. We are not responsible for typographical errors. All merchandise subject to prior sale. Phone orders welcome. Foreign orders require special handling. Prices subject to change without notice. 20% restocking fee for returned orders.

# NEW!!! 1996 PRINT Catalog!

## PRINT™



### 1996

**Products International  
EQUIPMENT, TOOLS & SUPPLIES  
FOR ELECTRONIC PRODUCTION  
MAINTENANCE & SERVICE**

**We Make Ordering Simple!**

**TOLL FREE 800-638-2020**

**FAX 800-545-0058**

**IN MARYLAND**

**CALL 301-587-7824**

**FAX 301-585-5402**



8931 Brookville Road \* Silver Spring, Maryland 20910 \* 800-638-2020 \* Fax 800-545-0058

**Call 800-638-2020 today for your free  
copy of the NEW 84 page 1996 catalog,  
jam packed with the best values in test and  
measurement instruments available today!!!**

# DO-IT-YOURSELF AUDIO AMPLIFIER KITS

Mark V Electronics, Inc.  
8019 E. Slauson Ave.,  
Montebello, CA 90640

Enclosures at Unbeatable prices!

Mention AD and  
take 10% off your  
1st order!

Free Catalog 213/888-8988 Fax 213/888-6868

In business since 1985

Order 1-800-521-MARK / 1-800-423-FIVE

Kit skill levels are specified as ▲ beginner ▲▲ intermediate or ▲▲▲ advanced!

## Metal Cabinets with Aluminum Front Panel

Best Buy



LG- Black anodized rack cabinet

LG-1273 3x12x7"	\$ 26.50
LG-1684 4x16x8"	32.50
LG-1924 4x19x11 1/2"	38.25
LG-1925 5x19x11 1/2"	42.00
LG-1983 2 1/4x19x8"	35.25
LG-1923 3x19x11 1/2"	36.50
LG-1927 7x19x11 1/2"	50.50

New

*LL-1923B 2 1/4x19x12"	69.50
*LL-1925A 5x19x12"	79.50

\*LL- High quality full Aluminum Cabinet  
\*LL- Front panel .157" & other panels .078"  
\*LL- Gold plated cap screw for front panel

- Dimensions in inches ± .05  
- Custom-made for other dimensions  
if over 100 pcs for single model!

## Modular Desktop Consoles

L x W x H	
LE-453 4x4 1/4x3"	\$ 7.50
LE-653 6x4 1/4x3"	9.75
LE-853 8x4 1/4x3"	11.75
LE- Black finished aluminum panel 1mm thick.	

## Camera Housing

*LD-1244 2 1/4x10 3/4x4"	\$55.00
**LD-1516 3 1/4x13 3/4x4"	29.50
**LD-1565 4x13 3/4x5 1/4"	31.75
*LD- Stainless Steel 0.7mm	
*LD- Sheet Metal 1mm	

## Alarm Box with Lock

Mejor Compra!

LB-1085 8 1/4x10 1/2x5"	\$18.75
LB-1395 9 1/4x13 1/4x5"	25.50
LB-1525 12 1/2x15 1/4x5"	35.25
*LB-1494 9 1/4x14 1/4x4 1/4"	21.50
LB-1383A 8 1/2x13 1/4x4"	23.25
*No lock & LB- Sheet Metal 0.8mm	

## Power Transformers & \*\*Toroidal Transformer

001 28/30V x 2 6A	\$ 30.00
002 36V x 2 3A	25.00
003 40V x 2 6A	32.00
**008 28/30V x 2 6A	40.00
**009 48/53V x 2 8A	66.00
**012 33/40/42Vx2 6A	48.00

## TA-800MK2 ▲▲ 120+120W Pre & Main Stereo Amp. (4 lbs.)

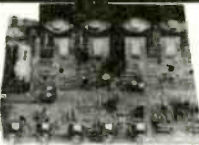

Kit: \$ 67.92  
Asmb. \$ 86.95

Power Output: 120W into 4 ohms RMS. 72W into 8 ohms RMS. Frequency Response: 10-20KHZ. THD: <0.01%. Tone Control: Bass ±12dB, Mid & Treble ±8dB. Sensitivity: Phono Input, 3mV into 47K. Line, 0.3V into 47K. Signal to Noise Ratio: 86dB. Power Requirement: 40VDC @ 6A. Suggested Mark V model 001 or 008 transformer. Recommended Metal Cabinet LG-1924.

## TY-35 ▲ FM Wireless Microphone

Clearance Sale



Kit: \$ 12.50  
\$ 6.99

This is a low power real FM transmitter. Transmit frequency within 88 to 108 megahertz. Transmit range about 200 ft. It has high sensitivity sound pickup by a capacitance microphone. May be used strictly for series purposes such as remote wireless monitoring.

## AF-3 ▲▲▲ 300W MOSFET High Power Mono Amp. (7 lbs.)

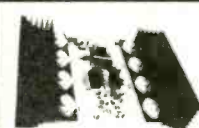

Kit: \$ 165.00  
Asmb. \$ 195.00

Power Output: 300W into 4 ohms RMS. 200W into 8 ohms RMS. Frequency Response: 10HZ-20KHZ. THD: <0.03%. Signal to noise ratio: 91dB. Input Sensitivity & Impedance at 1KHZ, 1V 47K Load Impedance 4-16 ohms. Power Requirement: ±55 to ±65VDC 8A. Suggested Mark V model 009 Transformer. Capacitor 10,000uf 80-100V model 016 or 019. Recommended Metal Cabinet LG-1925 for each channel.

## TR-503▲ Regulated DC Power Supply



Kit: \$ 18.75  
Asmb. \$ 27.95

It is short circuit proof and has overload protection. Output voltage is variable over a range of 0-50V. Current limit trip is adjustable up to max of 3A. Suggested Mark V 002 transformer. (1 lb.)

## TA-388 ▲▲▲ Class A FET Dynamic Buffer Stereo Pre-Amp (1 lb.)



Kit: \$ 64.00  
Asmb. \$ 80.00

Frequency Response (at rated output): Overall 10HZ-100KHZ +0.5dB-1dB. THD: Overall <0.007% at or below rated output level. Channel Separation (at rated output 1KHZ): Overall better than 70dB. Hum & Noise: Overall better than 90dB. Input Sensitivity (1KHZ for rated output): 300-600mV. Maximum Output Level: Pre-Amp output 1.8V (0.1% THD). Power Requirement: 30V X 2 AC 500mA.

## SM-100 ▲▲▲ 150 MHZ 8 Digit Frequency Counter (2 lbs.)



Kit: \$ 79.00  
Asmb. \$ 99.00

Sale

Frequency Range: 10HZ-150MHZ. Gate Time: 0.01s, 0.1s, 1s, 10s. Input Sensitivity: KHZ range 10HZ-10MHZ 20mV(min.). MHZ range 1MHZ-120MHZ 20mV(min.), 120MHZ-150MHZ 35mV (min.), 150MHZ-200MHZ 40mV(typical). Time Base: 10MHZ crystal, ±10 ppm. Input Impedance: 1M ohm. Response Time: 0.2s. Resolution: 0.1 HZ: 10s gate time, 1HZ: 1s gate time, 10HZ: 0.1s gate time, 100 HZ: 0.01s gate time. Hold the last input signal. Reset counter to 0. DC 9V power adapter not included.

## School Project Kits Source ...

SM-36 Dynamic Noise Reduction ▲	\$ 26.00
TA-006 6W Mini-Amplifier ▲	9.50
TA-28 Digital Voice Memo ▲▲	9.90
TA-120 36W Class A Power Amp. ▲▲	32.50
TA-201 Microphone Mixer Mono Amp▲	20.79
TY-45 20 Bar/Dot Level Display ▲▲	38.25
TY-2 Fluorescent Light Driver ▲	14.75
TA-50 Melody Generator ▲	9.90

## SM-720 AC/DC Stereo Pre & Main Power Amp.



Kit: \$ 77.00  
Asmb. \$ 102.00

120Wx2 Music power. THD: <0.2%. Input Sensitivity: Tape, CD/Aux 300mV 47k ohm, Phono 3mV 47k ohm, Guitar/Mic 3mV (600-47k ohm). Tone Control: Treble & Bass ±8dB. Frequency Response: 20Hz-20kHz. Signal to Noise Ratio: 78dB. Power Requirement: AC 110/60Hz or DC 12-16V. Ready to plug in when assembled. Case & transformer included! ▲▲▲ (9 lbs.)

See our catalog for more kits!

Minimum order \$ 20. We accept Visa, MasterCard & Money Orders. Checks allow 2 weeks for clearance. We ship by UPS ground inside US (2 lbs min \$ 5.00) and ship by US mail outside US. Please call for orders shipping & handling or fax (foreign) orders. PO Orders are welcome from schools. We are not responsible for typographical errors.



## B<sup>2</sup> SPICE v 2.0

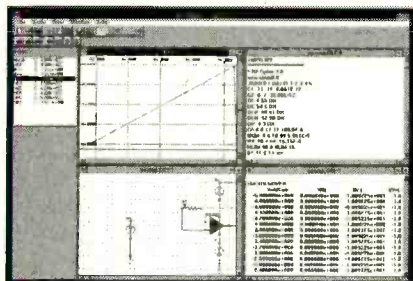

## B<sup>2</sup> LOGIC v 3.0

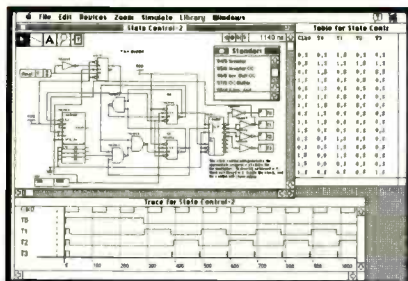

for windows™ and macintosh™

**B<sup>2</sup> SPICE v 2.0 \$199**

- Simulations: Transient, DC, AC, Noise, Distortion, & More
- Build your own symbols & parts
- Full SPICE 3f5 implementation
- Hundreds of devices
- Device & Model Property Editing
- Flexible Visualization of Results: customized graphs and tables
- Version 2.0 for Windows
- Version 1.1 for Mac & Power Mac

**B<sup>2</sup> Logic v 3.0 \$199**

- EDIF File Format Output
- Enhanced PLD Simulation Capture
- Subcircuit Probing
- Over 100 components available

**ELECTRONIC DESIGN PACKAGE \$299**

- Includes B<sup>2</sup> SPICE & B<sup>2</sup> LOGIC
- Demo Disks Available
- University & Student Prices Available
- Site Licenses Available
- Dealer Inquiries Welcome

## Why Design Circuits the Hard Way?

**B<sup>2</sup> SPICE** and **B<sup>2</sup> LOGIC** are the most powerful and affordable integrated analog and digital circuit design, simulation, and analysis packages available. B<sup>2</sup> SPICE and B<sup>2</sup> LOGIC neatly integrate the schematic editor, simulator, and graphics post processor. They are fully integrated and interactive and are extremely easy to use for **Windows™, Macintosh™, and Power Mac™**. Both B<sup>2</sup> SPICE and B<sup>2</sup> LOGIC are currently in use at over 100 major universities and many leading Fortune 500 companies such as The University of Michigan, Stanford, AT&T, General Electric, and Hewlett Packard, to mention a few!



### Beige Bag Software

1756 Plymouth Road • Suite 370  
Ann Arbor • Michigan • 48105

Phone 313. 332. 0487

Fax 313. 332. 0392

E-Mail [info@beigebag.com](mailto:info@beigebag.com)

Url <http://www.beigebag.com>

CIRCLE 335 ON FREE INFORMATION CARD

## CABLE TV Universal Descrambler

### NEW PRODUCT

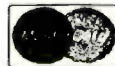

### MODEL 5000 Fully Assembled \$199.95

Our fully assembled product is tested and *Guaranteed* to work on your system. We will also include an AC adaptor and complete hookup instructions. This unique product will be available for a limited time only!

### 4000 And 5000 Features

- The latest in Video Amplification Technology.
- New clocking circuits to stabilize color and picture performance.
- The most advanced picture locking circuitry.
- Inverted Video Option is available.
- Connects easily to your VCR.
- NO converter box is necessary.

The Halcyon Group  
**1-800-664-6999**

Anyone implying theft of cable service will be denied assistance.

### Model 4000 Kit \$79.95

The 4000 KIT comes with electronic components and Cad designed PC board. We provide schematic, parts list, wiring diagram, tutorial guide, and **FREE** in-house support.

### Model 4000A Enc. Pack \$44.95

The 4000A Enclosure Pack provides the hobbyist, a custom enclosure, AC adaptor and finish accessories to give your kit the professional look.

## CRYSTAL CONTROLLED SURVEILLANCE

VHF & UHF PROFESSIONAL ENCASED PARTIALLY ASSEMBLED TRANSMITTER KITS

Countersurveillance. Also Tunable 70 to 305 MHz Kits. We Design & Manufacture Our Equipment. Custom Design.

FOR CATALOG SEND \$2.00 TO:

SHEFFIELD ELECTRONICS CO., P.O. Box 377940-C  
Chicago, IL 60637-7940. Tel. (312) 324-2196

## !!! BROADCAST FARTHER !!!

The model 1525 is a 75-110MHz RF amplifier that connects to mono or stereo FM transmitters and produces a powerful 15-20 watt signal which could broadcast up to 5 miles or more! Requires 75-250 mW drive.

Step by step plans complete with part source information and antenna designs . . . **ONLY \$14 PLUS \$2 S&H NO C.O.D.'s**

**Progressive Concepts**  
BOX 586 STREAMWOOD, IL 60107  
(708)736-9822 FAX: (708)736-0353



## Robot Explorer Newsletter

Nano-ants, flying robots, Martian explorers. Explore an entire universe of exciting robots. 8 information-packed issues for only \$14.95. Call now! MasterCard/Visa Accepted.

1-(800) GO-ROBOT or 1-(800)467-6268

SEE US  
NOW AT  
<http://www.cir.com>

**CIRCUIT  
SPECIALISTS  
INC.**

**Check Out  
What  
We  
Have  
To Offer:**

**Fantastic DMM Offer!!!**

Don't let the price fool you. This meter is a digital multimeter designed for engineers and hobbyists. Equipped with 5 functions and 19 ranges. Each test position is quickly and easily selected with a simple turn of the FUNCTION/RANGE selector rotary switch.

**Rubber Boot Included**  
General  
Display: 3-1/2 Digit LCD, 21mm Figure Height with Automatic Polarity  
Overrange Indication: 3 Least Significant Digits Blank  
Temperature for Guaranteed Accuracy: 23°C±5°C RH<75%  
Temperature Ranges:  
Operating: 0°C to 40°C (32°F to 104°F)  
Storage: -10°C to 50°C (14°F to 122°F)  
Power: 9V Alkaline or Carbon-Zinc Battery (NEDA1604)  
Low Battery Indication: BAT on Left of LCD Display.  
Dimensions: 188mm long x 87mm wide x 33mm thick  
Net Weight: 400g



**Our  
Best  
Offer  
Ever  
on a  
High  
Quality  
Full Sized  
DMM**

**\$19.00**  
any qty

**DC Voltage (DCV)**  
Range: Resolution: Accuracy:  
200mV 100µV  
2000mV 1mV  
20V 10mV ±(1%rdg+2dpts)  
200V 100mV  
1000V 1V  
Maximum Allowable Input: 1000V DC or Peak AC.

**DC Current (DCA)**  
Range: Resolution: Accuracy:  
200µA 100nA  
2000µA 1µA ±(1.2%rdg+2dpts)  
20mA 10µA  
200mA 100µA  
10A 10mA ±(1.2%rdg+2dpts)  
Overload Protection: mA Input: 2A/250V fuse.

**AC Voltage (ACV)**  
Range: Resolution: Accuracy:  
200V 100mV ±(1.2%rdg+10dpts)  
750V 1V  
Frequency Range: 45Hz-450Hz  
Maximum Allowable Input: 750V rms  
Response: Average Responding. Calibrated in rms of a Sine Wave.

**Resistance (Ω)**  
Range: Resolution: Accuracy:  
200Ω 100mΩ  
2000Ω 1Ω  
20KΩ 10Ω ±(1.2%rdg+2dpts)  
200KΩ 100Ω  
2000KΩ 1KΩ  
20MΩ 10KΩ ±(2%rdg+10dpts)  
Maximum Open Circuit Voltage: 2.8V

**Diode Test**  
Measures forward voltage drop of a semiconductor junction in mV test current of 1.5mA Max.

**Continuity**  
The beeper will sound when the resistance of circuit under measurement is less than 30Ω.

**hFE Test**  
Measures transistor hFE.

CAT NO	DESCRIPTION	PRICE
9300G	Rugged High Quality DMM with Rubber Boot	\$19.00

**Switchable Scope Probe Sets**

(Selectable X1/Ref/X10) These high quality scope probe sets are for oscilloscopes up to 60MHz (model HP 9060) or 150MHz (model HP 9150). Both sets include a handy storage pouch and include an IC test-hook adapter for the probe. The BNC connector rotates to avoid cable tangle or kink. Cable length is 1.4 meters.

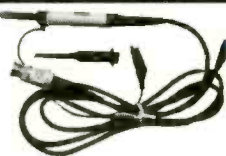

CAT NO	DESCRIPTION	PRICE EACH		
		1	10	100
HP-9060	Scope Probe Set DC~60MHz	\$16.49	\$14.49	\$11.58
HP-9150	Scope Probe Set DC~150MHz	24.95	21.95	18.62

**Positive Photo Resist Pre-Sensitized Printed Circuit Boards**



These pre-sensitized printed circuit boards are ideal for small production runs. They provide high resolution and excellent line width control. High sensitive positive resist coated on 1oz. copper foil allows you to go direct from your computer plot or art work layout. No need to reverse art.

**Single-Sided, 1oz. Copper Foil on Paper Phenolic Substrate**

CAT NO	DESCRIPTION	PRICE EACH		
		1	10	50
PP101	100mm x 150mm/3.91" x 5.91"	\$2.55	\$1.90	\$1.70
PP114	114mm x 185mm/4.6" x 6.6"	2.98	2.45	1.98
PP152	150mm x 250mm/5.91" x 9.84"	5.40	3.98	3.60
PP153	150mm x 300mm/5.91" x 11.81"	6.15	4.48	4.10

**Single-Sided, 1oz. Copper Foil on Fiberglass Substrate**

CAT NO	DESCRIPTION	PRICE EACH		
		1	10	50
GS101	100mm x 150mm/3.91" x 5.91"	\$ 3.90	\$2.98	\$2.60
GS114	114mm x 185mm/4.6" x 6.6"	4.80	3.49	3.20
GS152	150mm x 250mm/5.91" x 9.84"	8.69	5.98	5.78
GS153	150mm x 300mm/5.91" x 11.81"	10.20	7.20	6.80

**Double-Sided, 1oz. Copper Foil on Fiberglass Substrate**

CAT NO	DESCRIPTION	PRICE EACH		
		1	10	50
GD101	100mm x 150mm/3.91" x 5.91"	\$ 5.07	\$3.68	\$3.38
GD114	114mm x 185mm/4.6" x 6.6"	5.95	4.29	3.99
GD152	150mm x 250mm/5.91" x 9.84"	10.47	7.39	6.98
GD153	150mm x 300mm/5.91" x 11.81"	11.95	8.69	8.30

**Etching Chemicals/Ferric Chloride**

A dry concentrate that mixes with water to make 1 pint of etchant, enough to etch 400 sq. inches of 1oz board.

CAT NO	DESCRIPTION	PRICE EACH	
		1	5
ER-3	Makes 1 pint	\$3.50	\$2.75



**Developer** This product is used as the developer on our positive photo-resist printed circuit boards. Includes instructions. 50 gram package, mixes with water.

CAT NO	DESCRIPTION	PRICE EACH		
		1	10	25
POSDEV	Positive Developer	\$ .95	\$ .80	\$ .50

**Etching Tank** This handy etching system will handle PC boards up to 8" x 9", two at a time. Ideal for etching your PCB's! System includes an air pump for etchant agitation, a thermostatically controlled heater for keeping etchant at optimum temperature and a tank that holds 1.35 gallons of etchant. A tight fitting lid is also supplied to prevent evaporation when system is not being used. Typical etching time is reduced to 4 minutes on 1oz. copper board!



**REDUCES ETCHING TIME!**

CAT NO	DESCRIPTION	PRICE
12-700	Etch Tank System	\$37.95

**Desoldering Pumps**

These powerful plastic body desoldering pumps are designed for easy one hand operation for fast, efficient desoldering. Double O-ring piston seals for maximum suction.

CAT NO	DESCRIPTION	PRICE EACH		
		1	5	10
08-366S	Large Desoldering Pump	\$15.89	\$13.49	\$11.95
08-366E	Regular Desoldering Pump	10.89	8.59	7.39
08-366TIP	Replacement Tip	1.95	1.95	1.95



**SEE OUR ON-LINE CATALOG AT**  
<http://www.cir.com>

**Electronic Soldering System** Here's the ideal solution when **Temperature Control** is required. Easy to use slide control allows user to set system from 300°F to 840°F. Voltage to iron from control unit is 24V Iron heating power is 48W. Replaceable 5.3mm tip is standard. Replacement irons and tips are available.

**Electronic Soldering System with LED Display**

Deluxe temperature controlled system with LED display for maximum accuracy. Temperature is adjustable from 160°-480°C (320°-900°F). Iron heating power is 48 Watts. Runs on 24V from controller unit. Replacement irons and tips are available. Tip size is 5.3mm.

CAT NO	DESCRIPTION	PRICE EACH	
		1	5
SL10	Temp Controlled Soldering Iron	\$56.00	\$50.00
SL24V	Spare 24V Soldering Iron	10.50	7.50



CAT NO	DESCRIPTION	PRICE EACH	
		1	5
SL30	Deluxe Soldering System w/LED	\$86.00	\$75.00
SL24V	Spare 24V Soldering Iron for SL10 or SL30	10.50	7.50



**Replacement Tips for SL10/SL30**

We now offer a variety of replacement tips for the SL10/SL30 soldering stations.

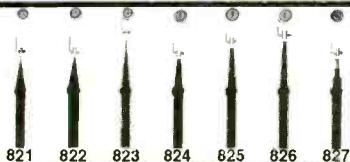

CAT NO	DESCRIPTION	PRICE EACH	
		1	5
821	1/32" Pencil Tip	\$1.39	\$1.19
822	1/32" Pencil Tip	1.39	1.19
823	1/64" Pencil Tip	1.39	1.19
824	1/16" Chisel Tip	1.49	1.29

CAT NO	DESCRIPTION	PRICE EACH	
		1	5
825	1/8" Chisel Tip	\$1.49	\$1.29
826	3/64" Chisel Tip	1.49	1.29
827	3/64" Pencil Tip	1.59	1.39

**Ball Bearing 12V DC Fans**

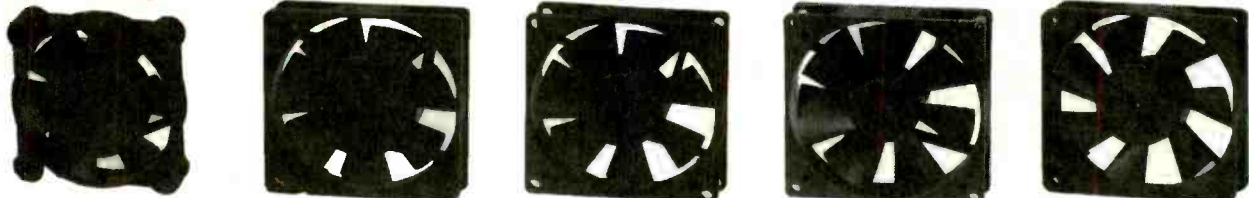

These High Quality Fans feature Ball Bearings and Brushless DC Motors. All of them are designed to meet UL, CSA & VDE Standards. Design these fans into power supplies, computers or other equipment requiring additional air flows for heat removal. These fans are regular Circuit Specialists stock items — they are not surplus.

CAT NO	DESCRIPTION	PRICE EACH			
		1	10	25	100
CSD 4010-12		\$ 9.88	\$ 6.38	\$5.48	\$4.87
CSD 6025-12		9.38	5.91	5.41	4.71
CSD 8025-12		8.88	5.85	5.19	4.49
CSD 9225-12		8.95	6.14	5.29	4.59
CSD 1225-12		11.45	8.96	7.82	6.85

**INDUSTRY BEST PRICING!**

**Specifications**

CAT NO	DIMENSIONS (MM)	RATED VOLTAGE (V)	START VOLTAGE (V)	INPUT CURRENT (A)	AIR FLOW (CFM)	STATIC PRESSURE (INCH-H <sub>2</sub> O)	SPEED (RPM)	NOISE LEVEL (dB)	WEIGHT (g)
CSD 4010-12	40x40x10mm	12	7	0.06	5.1	0.19	5,500	26	20
CSD 6025-12	60x60x25mm	12	5	0.13	13.7	0.165	4,500	28	65
CSD 8025-12	80x80x25mm	12	5	0.16	37.8	0.177	3,000	31	80
CSD 9225-12	92x92x25mm	12	5	0.32	42	0.18	2,800	37	95
CSD 1225-12	120x120x25mm	12	5	0.35	62	0.180	2,500	42	135

- SOLDER • SOLDER • SOLDER •
- SOLDER • SOLDER • SOLDER •

We stock high quality 60/40(Sn%/Pb%), .031" and 63/37, .031" diameter. This is prime JIS certified solder that we maintain as a regular stock item (It is not "Left-overs, Rejects or Surplus") and you can buy it from us at a fraction of the price that you are used to.



**Tired of Paying Inflated Prices for Solder?**

CAT NO	DESCRIPTION	PRICE EACH		
		1	10	25
RH60-1	1-lb. Spool, .031", 60/40	\$ 6.90	\$ 5.96	\$ 5.30
RH63-1	1-lb. Spool, .031", 60/40	6.95	6.10	5.41
RH60-4	4.4-lb. Spool, .031", 60/40	24.00	21.90	17.92
RH60-TUBE	6-oz. Tube, .031", 60/40	.99	.89	.79

**CCD Camera - IR Responsive**

As Low As \$109!!

This black and white monochrome CCD Camera is totally contained on a PCB (70mm x 46mm). The lens is the tallest component on the board (27mm high from the back of the PCB) and it works with light as low as 0.1 lux. It is IR Responsive for use in total darkness. It comes with six IR LED's on board. It connects to any standard monitor, AUX or video input on a VCR or through a video modulator to a TV. Works with a REGULATED 12V power supply (11V-13V). Hooks up by connecting three wires: red to 12V, black to ground (power & video) and brown to video signal output.



CAT NO	DESCRIPTION	PRICE EACH	
		1	5
CA-H34A	PCB Mounted IRCCD Camera	\$125.00	\$109.00

**SEE OUR ON-LINE CATALOG AT <http://www.cir.com>**

**CIRCUIT SPECIALISTS, INC. SINCE 1971**

**800-811-5203  
602-464-2485  
602-464-5824(FAX)**

**WE ACCEPT:**



**RECEIVE OUR LATEST 132 PAGE CATALOG!**

It's chock full of all types of electronic equipment and supplies. We've got I.C.'s, capacitors, resistors, pots, Inductors, test equipment, breadboarding supplies, PC supplies, industrial computers, data acquisition products, personal computers and computer parts, plus much, much more. FAX us your name and address or call 800-811-5203, ext. 5, to leave a message on our catalog request line.



# DIGITAL STORAGE OSCILLOSCOPE

WITH  
SPECTRUM  
ANALYZER,  
DVM, FREQ.  
COUNTER,  
AND DATA  
LOGGER.

**\$189.**

**O-SCOPE  
MODULES  
CONVERT PC'S  
INTO  
MULTIPURPOSE  
TEST AND  
MEASURING  
INSTRUMENTS.**

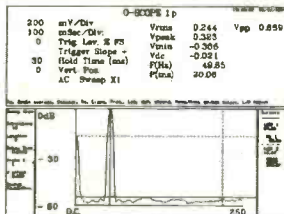
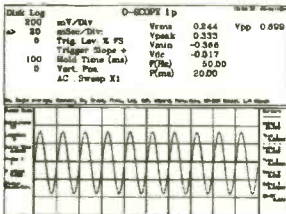
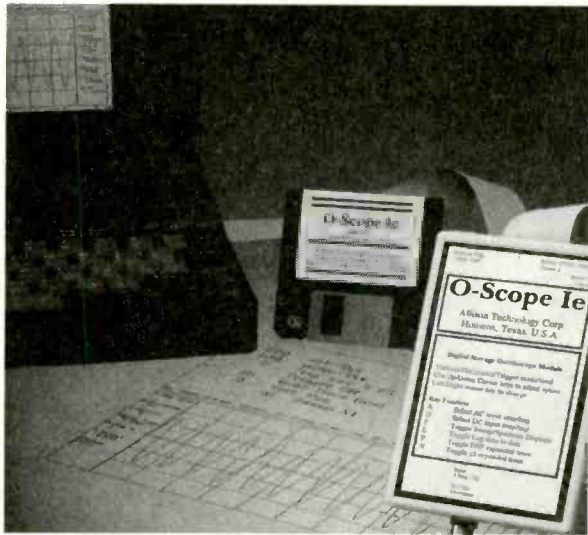

## FEATURES:

- SMALL & PORTABLE
- USES PRINTER PORT
- USES STD. PROBES
- DC TO 50 KHz
- 10v/div. TO 50 mv/div.
- MADE IN U.S.A.
- SAME DAY SHIPPING

## OPTIONS:

- PROBE SETS
- EXTERNAL TRIGGER
- DUAL TRACE
- X-Y PHASE DISPLAY
- EXTENDED BANDWIDTH
- EXTENDED INPUT RANGE
- BATTERY PACK

INCLUDES SOFTWARE & INSTRUCTIONS.

ASSEMBLED AND TESTED..... \$169.

ENHANCED SOFTWARE..... \$ 20.

KIT (WITHOUT CASE)..... \$129.

SHIPPING: \$7.50 (2ND DAY \$11.50)

TO ORDER: SEND CREDIT CARD INFO., M.O., or CHECK, OR  
YOU MAY CALL **1-800-980-9806**

## ALLISON TECHNOLOGY CORPORATION

8343 CARVEL, HOUSTON, TX. 77036 U.S.A.  
PHONE: 1-713-777-0401 FAX: 1-713-777-4746  
BBS: 1-713-777-4753

# 386 SBC \$83

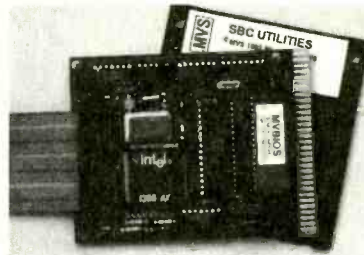

OEM (1K) PRICE  
INCLUDES:  
- 5 SER (8250 USART)  
- 3 PAR (32 BITS MAX)  
- 32K RAM, EXP 64M  
- STANDARD PC BUS  
- LCD, KBD PORT  
- BATT. BACK RTC  
- IRQ0-15 (8259 X2)  
- 8237 DMA 8253 TMR  
- BUILT-IN LED DISP.  
- UP TO 8 MEG ROM  
- CMOS NVRAM  
USE TURBO C,  
BASIC, MASM  
RUNS DOS AND  
WINDOWS  
EVAL KIT \$295

## \$95 SINGLE PIECE PRICE UNIVERSAL PROGRAMMER

- DOES 8 MEG EPROMS
- CMOS, EE, FLASH, NVRAM
- EASIER TO USE THAN MOST
- POWERFUL SCRIPT ABILITY
- MICROCONT. ADAPTERS
- PLCC, MINI-DIP ADAPTERS
- SUPER FAST ALGORITHMS

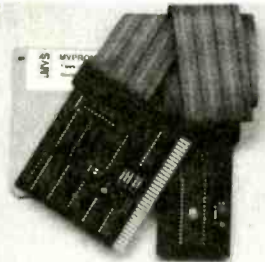

OTHER PRODUCTS:  
8088 SINGLE BOARD COMPUTER ..... OEM \$27 ... \*95  
PC FLASH/ROM DISKS (128K-16M) ..... 21 ..... 75  
16 BIT 16 CHAN ADC-DAC CARD ..... 55 ..... 195  
WATCHDOG (REBOOTS PC ON HANGUP) ..... 27 ..... 95

\*EVAL KITS INCLUDE MANUAL  
BRACKET AND SOFTWARE.  
5 YR LIMITED WARRANTY  
FREE SHIPPING  
HRS: MON-FRI 10AM-6PM EST

**MVS BOX 850  
MERRIMACK, NH  
(508) 792 9507**

## DATA ACQUISITION and Control Hardware for PC's

ANA100 Analog I/O ..... \$ 99      DIG100 Digital I/O ..... \$ 39



- \* 8 Channel 8-Bit
- \* 0 to 5 Volt Input
- \* 14 TTL I/O lines
- \* Analog Output
- \* 400KHz Sampling



- \* 8255 PPI
- \* 24 or 48 TTL I/O Lines option
- \* Selectable Base Address

ANA150 Analog/Counter... \$ 89



- \* 8 Channel 8-Bit
- \* 0 to 5 Volt input
- \* 3 16-Bit Counters
- \* 400KHz Sampling

DIG200 Counter I/O ..... \$ 79



- \* 3 16-Bit Counters
- \* 8 TTL Input lines
- \* 8 TTL Output lines
- \* Selectable Clock Frequency input

ANA200 Analog I/O ..... \$ 79



- \* 1 Channel 12-Bit
- \* 0 to 5 Volt input optional bi-polar
- \* 100KHz / 300KHz Sampling rate
- \* 24 TTL I/O lines

ANA201 Analog ..... \$ 129



- \* 8 Channel 12-Bit
- \* x1, x5, x10, x50 Programmable Channel gain
- \* 100KHz/300KHz Sampling rate

## Engineering Software - PC/MSDOS

Easy-PC Professional XM - Integrated Electronics  
CAE System, Combines Schematic Capture,  
Simulation, and PCB Design in one package... \$ 349

More Hardware and  
Software Items  
Ask for our current catalog

PC-SCOPE - Digital Storage Oscilloscope, 1, 2, 4, or  
8 Channel Capture and Display of Data. Works with  
ANA100, ANA150, and ANA201 Boards..... \$ 39

We accept  
MasterCard/Visa Orders

## BSOFT Software, Inc.

PHONE 614-491-0832 \* FAX 614-497-9971  
444 COLTON ROAD \* COLUMBUS, OHIO \* 43207

# Books that work the way you work...

**SPECIAL OFFER**  
No obligation



**NEW FROM JOHN LENK**



1996, paperback  
~~\$29.95~~ \$26.95  
0-7506-9821-7

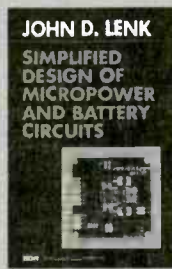

1996, paperback  
~~\$29.95~~ \$26.95  
0-7506-9510-2



1996, paperback  
~~\$29.95~~ \$26.95  
0-7506-9820-9



June 1996, paperback  
~~\$29.95~~ \$26.95  
0-7506-9508-0

Butterworth-Heinemann brings you something for everyone from John Lenk's Simplified Design Series. These books are all-inclusive, one-stop guides. Each has step-by-step instructions and diagrams that make it easy-to-use for the student, experimenter, and professional. All are available in paperback.

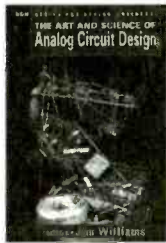

1995, hardcover  
~~\$49.95~~ \$44.95  
0-7506-9505-6

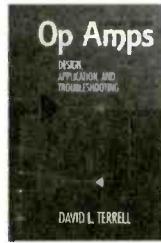

1996, hardcover  
~~\$49.95~~ \$44.95  
0-7506-9702-4



1995, paperback  
~~\$29.95~~ \$26.95  
0-7506-9694-X

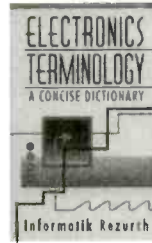

1996, paperback  
~~\$12.95~~ \$10.95  
0-7506-9751-2



1996, paperback  
includes disk  
~~\$39.95~~ \$35.95  
0-7506-9700-8

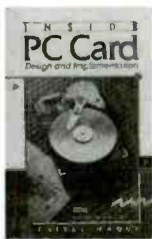

July 1996, hardcover  
~~\$49.95~~ \$44.95  
0-7506-9747-4



1995, paperback  
~~\$47.95~~ \$42.95  
0-7506-2489-2

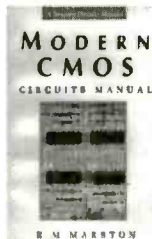

1996, paperback  
~~\$28.95~~ \$25.95  
0-7506-2565-1



1995, paperback  
~~\$47.95~~ \$42.95  
0-7506-2281-4

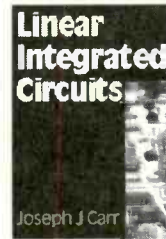

1996, paperback  
~~\$37.95~~ \$33.95  
0-7506-2591-0

Please send me the book(s) listed below at 10% off! Phone: 1-800-366-BOOK FAX: 1-800-446-6520

Please add \$4.00 for handling for the first item ordered and \$1.50 for each additional item ordered to all check and credit card orders. Billed orders will be charged additional shipping based on weight and destination. All US orders must include your state sales tax. Prepayment or company purchase order is required for all orders. Canadian customers please pay by credit card or in US funds and include 7% GST on books and handling. Prices subject to change without notice.

Write book number(s) here

--	--	--	--

Charge my:  VISA  AMEX  MC Card # \_\_\_\_\_ EXP Date \_\_\_\_\_

Name \_\_\_\_\_ Signature \_\_\_\_\_

Address \_\_\_\_\_ City/ State/ ZIP \_\_\_\_\_

Tel \_\_\_\_\_ E-mail \_\_\_\_\_

Visit us on the Internet @ <http://www.bh.com/bh/el>

Send me a FREE catalog (item 642)



313 Washington Street, Newton, MA 02158  
from outside US and Canada, call 617-928-2500

TS123

CIRCLE 215 ON FREE INFORMATION CARD

June 1996, Electronics Now

Make your projects  
speak for themselves...  
Ours do!

### DIGITAL VOICE RECORDERS

- Record up to 218 seconds
- 1 to 8 messages
- High quality speech 12 bit
- Switch-closure actuation
- Sample rates up to 20Khz
- On-board backup
- Direct speaker output
- Wide operating range
- Small size 2.6" X 2.6"
- Made in U.S.A.

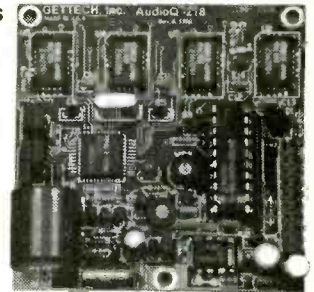

MODEL AudioQ™-218

Call or write for more information  
OEM price and delivery available  
Custom designs and enclosures  
Single unit price \$149.00 plus s+h  
Quantity pricing as low as \$99.00

## GETTECH, Inc.

402 Riley Road, New Windsor, NY 12553  
(914) 564-5347

Specifications and price subject to change.

### Advanced Circuit Designs will...

Test all functions and write code to perform the same task.

**PALS**  
**GALS**

Extract out the exact same fuse map, depending on the manufacturer and type.

**Microprocessors**

Extract out the exact same code for PIC, 16C54, 16C55, 16C56, 16C57, and 16C84.

Extract out the exact same code for Motorola 68705 series  
(U3, U5, R3, R5, P3, P5), 80993, and 68HC705C8.

ACD also works with Intel, AMD, and other microcontrollers not listed.

**Schematics**

Design/layout schematics, and generate printed circuit board gerber files for projects.

Call about our secure integrated circuit readers!

ACD can also provide additional resources for populating your circuit boards.

Disclaimer: ACD works with copyrighted secured devices only when the copyright holder is the customer. ACD also works with secured devices that have not been copywritten.

Call TODAY for a price quote!

(703) 764-5361

please leave a message



5765-F Burke Centre Parkway, Suite 317, Burke, Virginia 22015

(703) 764-5361

## ❖ ATTENTION CABLE VIEWERS ❖

CABLE VIEWERS... get back to your **BASIC** Cable Needs

**Call 800-577-8775**

For information regarding all of your **BASIC** cable needs.

**5 GOOD REASONS TO BUY OUR FAR SUPERIOR PRODUCT**

- ❖ **PRICE**
- ❖ **EFFICIENT SALES AND SERVICE**
- ❖ **WE SPECIALIZE IN 5, 10 LOT PRICING**
- ❖ **ALL FUNCTIONS (COMPATIBLE WITH ALL MAJOR BRANDS)**
- ❖ **ANY SIZE ORDER FILLED WITH SAME DAY SHIPPING**

We handle **NEW** equipment **ONLY** - Don't trust last year's **OBSOLETE** and **UNSOLD** stock!  
**COMPETITIVE PRICING—DEALERS WELCOME**

**HOURS: Monday-Saturday 9-5 C.S.T.**

It is not the intent of B.E.S.W. to defraud any pay television operator and we will not assist any company or individual in doing the same.  
\*Refer to sales personnel for specifications.

**P.O. Box 8180 ■ Bartlett, IL 60103 ■ 800-577-8775**



**BASIC  
ELECTRICAL  
SUPPLY &  
WAREHOUSING  
CORPORATION**

CIRCLE 334 ON FREE INFORMATION CARD

www.americanradiohistory.com

# New and Pre-Owned Test Equipment

Substantial **SAVINGS** on New & Pre-Owned B+K Precision, Fluke, Hewlett-Packard, Goldstar, Leader, Tektronix, and more ...

## Goldstar New Oscilloscope Specials

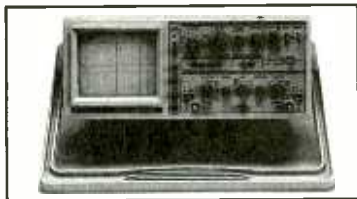

**FREE SHIPPING!**  
ON ALL GOLDSTAR EQUIPMENT  
ANYWHERE IN THE U.S.  
Excluding AK & HI

Model OS-9100P → **\$999.00**  
**Full 100 MHz Bandwidth!** **SUPER SALE!**

- Dual-Channel, High Sensitivity
- TV Synchronization Trigger
- Calibrated Delayed Sweep
- Includes Two Probes, 2 Year Warranty

### Professional Quality Digital Storage Oscilloscopes at Affordable Prices!

Bandwidth	20 MHz	40 MHz	60 MHz
Model	OS-3020	OS-3040	OS-3060
SALE Price	\$1,199.00	\$1,599.00	\$1,899.00

- Transmit and Receive Data with Standard RS-232C Interface
- Includes FREE Comprehensive Communication Software
- Waveform Save, Calculation, and Print
- Dual Channel, Delayed Sweep, TV Synchronization Trigger
- 20 MS/s Sampling Rate, Two Save Memories
- Switch Between Analog and Digital Modes
- CRT Readout Including Measurement Cursors
- Includes Two Probes, 2 Year Warranty

### 20 MHz Sweep/Function Generator Model 4040 \$499.00 **NEW!**

- 0.2 Hz to 20 MHz, 5 digit LED Display
- AM & FM Internal or External Modulation
- Sine, Square, Triangle, TTL, CMOS Outputs
- Burst Operation

### Pre-Owned Oscilloscope Specials

Tektronix 465	100 MHz	\$589.00
Tektronix 465B	100 MHz	\$689.00
Tektronix 475	200 MHz	\$749.00
Tektronix 475A	250 MHz	\$849.00

- Professionally Refurbished
- Calibrated to Original Specifications
- Dual Channel, Calibrated Delayed Sweep
- 90 Day Warranty

### LOWEST PRICES EVER! New Fluke Multimeters

The Industry Standard in Multimeters:

Model 75 Series II ...\$128.00	Model 83 ...\$232.00
Model 77 Series II ...\$153.00	Model 85 ...\$265.00
Model 79 Series II ...\$172.00	Model 87 ...\$285.00



### Power Supplies

Model 1680 Fixed 13.8V, 6A .....	\$50.00
Model 1682 Fixed 13.8V, 15A .....	\$99.00
Model 1740 0-40V, 6A Dual LED Meters .....	\$499.00
Model 1760 Tri-Output (2)0-30V, 2A (1)4-5.6V, 5A .	\$649.00

### Counters, Generators, Video Test, & More....

Model 1856A 2.4 GHz Multi-Function Counter .....	\$499.00
Model 1823 175 MHz Universal Counter .....	\$399.00
Model 1806 100 MHz Multi-Function Counter .....	\$249.00
Model 1211D Color TV Pattern Generator .....	\$235.00
Model 1249A NTSC Generator w/RGB .....	\$569.00
Model 4017 10 MHz Sweep/Function Generator .....	\$369.00
Model 1653 Isolated AC 1-150V, 2A Supply .....	\$319.00

Full line of Oscilloscopes, RF, Video & Audio Test Equipment,  
Power Supplies, Meters, Probes and Accessories.



**TOLL FREE 1-800-99-METER**

**1-800-996-3837**

Availability of Equipment Subject to Prior Sale  
Prices Subject to Change Without Notice

**FOTRONIC CORPORATION**  
P.O. BOX 708  
Medford, MA 02155  
(617) 665-1400  
FAX (617) 665-0780

CIRCLE 219 ON FREE INFORMATION CARD

\$449<sup>95</sup>

# Device Programmers

\$139<sup>95</sup>

48 PIN ZIF  
Connects to standard PC parallel printer port

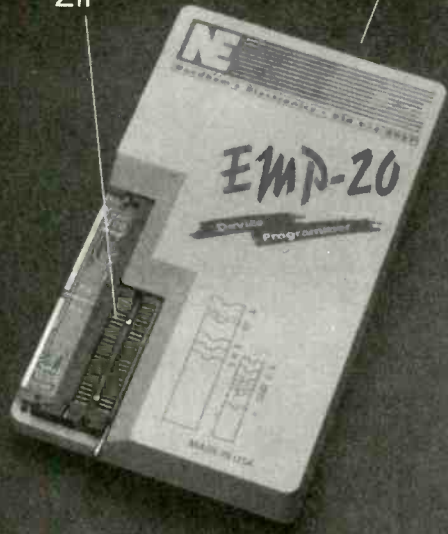

9 1/2 x 5 3/4 x 1 1/4

EMP-20

- Easy to use software, on-line help, full screen editor
- **Fast Programming (EMP-20)**  
27C010A, 23 seconds  
28C020, 34 seconds  
27C040, 95 seconds
- **Made in USA**
- 1 Year Warranty
- Technical Support by phone
- 30 day Money Back Guarantee
- FREE software upgrades available via BBS
- Demo SW via BBS (EM20DEMO.EXE) (PB10DEMO.EXE)
- **E(e)proms** 2716 - 8 megabit, 16 bit 27210-27240, 27C400 & 27C800,
- **Flash** 28F256-28F020, (29C256-29C010 (EMP-20 only))
- **Micros** 8741A, 42A, 42AH, 48, 49, 48H, 49H, 55, 87C51, 87C51FX, 87C751,752
- **GAL, PLD** from NS, Lattice, AMD-16V8, 20V8, 22V10 (EMP-20 only)

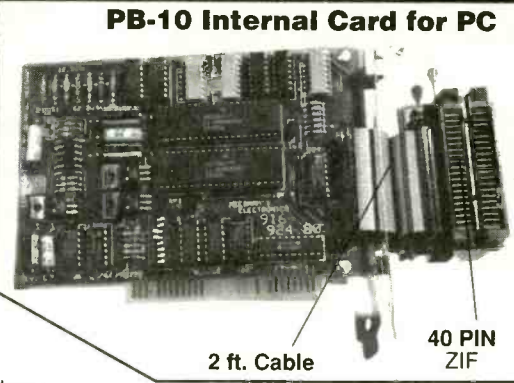

2 ft. Cable

40 PIN ZIF

FOR MORE INFORMATION CALL

4630 Beloit Drive, Suite 20  
Sacramento, CA 95838  
(Monday-Friday, 8 am-5 pm PST)

**NEEDHAM'S ELECTRONICS, INC.**



C.O.D.



**(916) 924-8037**

**BBS 916-924-8094**

**FAX 916-924-8065**

CIRCLE 257 ON FREE INFORMATION CARD

## RF POWER TRANSISTORS AND TUBES

In depth stocking of popular and hard-to-find Electronics Parts for Transmitters & Linear Amplifiers

### Popular Transistors

- 2SC1969
- 2SC2166 • 2SC2290
- 2SC2312C • 2SC2879
- MRF454 • MRF455
- MRF455A • MRF477
- MRF492 • MRF497
- SRF3749 • SRF7000-90

### Popular Tubes

- 6KD6 • 6LF6 • 6LQ6
- M2057 • 6146B • 6146W
- 3-500Z • 3-500ZG
- 811A • 572B • 7199
- 7558 • 8417 • 8873
- 8874 • 8875 • 8877

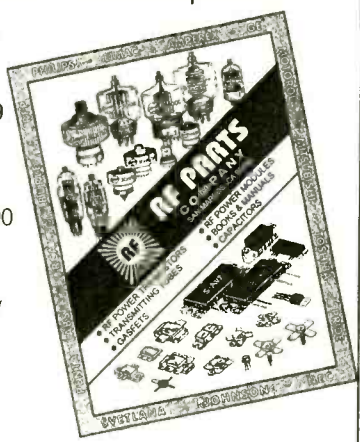

Order your FREE copy of our new Catalog by writing or calling us now.  
Tel: (619) 744-0700 • Fax: (619) 744-1943



**RF PARTS**  
435 SOUTH PACIFIC STREET  
SAN MARCOS, CA 92069

## TURN YOUR PC INTO A DIGITAL STORAGE OSCILLOSCOPE!

mission technology, Inc.'s MT-MultiScope now sold by Amaze Electronics

As featured in the April 1996 issue of Electronics Now!

At right: Actual scope screen as seen on your PC monitor.

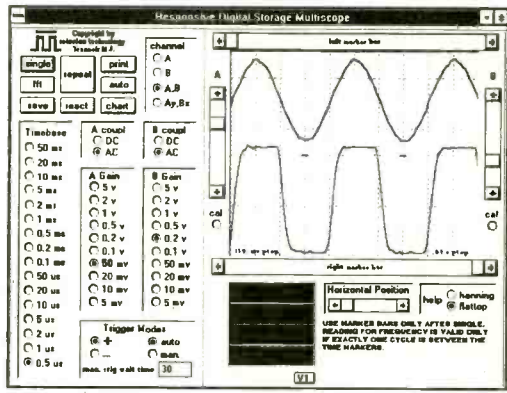

For industrial, hobbyist, educational, automotive, audio, and medical uses  
**\$399 + S/H.** Visa/MC/Check OK.  
Add \$99 for source code option

### FEATURES:

1. Dual channel, external triggered
2. Digital storage; MS Windows graphical user interface
3. Connects to PC parallel port
4. Programmable sampling intervals from 1 sample/8hrs to 20 million samples/1 second
5. Programmable gain from 5v/div to 5mV/div
6. Integrated 16 bit output
7. Visual Basic source code avail.

**AMAZE ELECTRONICS CORPORATION**  
amaze@hooked.net www.hooked.net/users/amaze  
Phone: 408-996-8943 Fax: 408-996-0366

Electronics Now, June 1996



# Parts Express™

## 301 Standard PanaVise

Designed for the professional and hobbyist, the model 301 turns, tilts and rotates to achieve the desired position. Durable nylon jaws open 2-1/4". Net weight: 3 lbs.

PANA VISE



#EN-365-305 ..... \$39<sup>95</sup> EACH

## Headband Magnifier

Features double lens for choice of 2.2x or 3.3x magnification and Velcro type headband. Net weight: 1/2 lb.



#EN-360-672 ..... \$19<sup>95</sup> EACH

## GoldStar Oscilloscopes

GoldStar

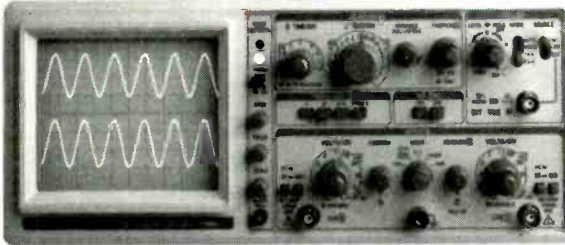

Part #	GoldStar #	Description	Price
EN-394-116	OS9100P	100MHz	\$899.95
EN-394-115	OS9060D	60MHz	699.95
EN-394-110	OS9040D	40MHz	599.95
EN-394-105	OS9020G	20MHz w/generator	449.95
EN-394-100	OS9020A	20MHz	349.95

## 150 MHz Oscilloscope Probe Kit

Deluxe probe kit features a modular design for longer life, switchable 10:1 probe with 150 MHz bandwidth, 2.8 ns rise time, and adjustable capacitance from 10-35 pF. 60" in length. Kit includes 6" detachable ground lead, sprung hook, trimming tool, 2 channel identifier clips, and replacement tip. Includes plastic case.



#EN-390-100 ..... \$29<sup>95</sup> EACH

## Weller WLC100 Soldering Station

The Weller WLC100 solder station is adjustable from 5 to 40 watts. Includes 40 watt pencil iron. UL approved. Net weight: 1-3/4 lbs. One year manufacturer warranty.



Weller

\$39<sup>95</sup>

#EN-372-120 ..... EACH

## Sure Shot 18" Dish for DSS®

Built heavier and stronger than OEM models, able to withstand 120 MPH wind gusts! "Perfect Curve" manufacturing process allows for maximum signal reflectivity. Ideal for replacement of damaged OEM dishes or for additional viewing locations. Sure Shot comes complete with mounting hardware and instructions. Limited lifetime warranty. LNBF not included. Net weight: 13 lbs.



#EN-210-405 ..... \$49<sup>95</sup> EACH

## Hot Shot 18" Dish for DSS®

The Hot Shot features the same quality construction as the Sure Shot, but also contains a safe low voltage, heating element that automatically eliminates ice, snow, and moisture from the dish surface. Hot Shot comes complete with mounting hardware, heater power supply and instructions. Note: 2 conductor, 18 gauge heater wire not included. Limited lifetime warranty. LNBF not included. Net weight: 27 lbs.

#EN-210-400 ..... \$139<sup>95</sup> EACH

## Grundig LNBFs

Made in England quality! Designed to work in extreme real world conditions. Features "true circular polarization". For use with the Sure Shot and Hot Shot dishes or as a replacement for lightning damaged RCA DSS LNBFs. Available in single or dual feed. 18 month warranty. Net weight: 1 lb.

#EN-210-420 (Single feed) ..... \$79<sup>95</sup> EACH

#EN-210-425 (Dual feed) ..... \$99<sup>95</sup> EACH

## CAIG DeoxIT Deoxidizer

DeoxIT is a fast-acting deoxidizing solution that cleans, lubricates, and improves conductivity on all metal connectors and contacts. Seals and protects all electrical connections. Reduces intermittent failures, arcing, wear, and abrasion. Temperature range: -34 degrees C to 200 degrees C. Use as a general treatment for connectors, contacts, and other metal surfaces.

CAIG LABORATORIES, INC.

NEW! MINI SPRAY



Part #	CAIG #/Description	Solution	Price (1-11)	Price (12-23)	Price (24-UP)
EN-341-200	DeoxIT D5, 5 oz. Spray	5%	\$7.95	\$7.15	\$6.45
EN-341-202	DeoxIT Mini Spray, 15 g.	5%	4.95	4.50	3.95
EN-341-205	DeoxIT D100, 2 oz. Spray	100%	10.95	9.85	8.65
EN-341-210	DeoxIT Pen Applicator	100%	9.95	8.95	8.05
EN-341-215	DeoxIT Vial w/brush, 7.4 ml.	100%	6.95	6.25	5.65
EN-341-220	DeoxIT Precision Dispenser	100%	14.95	13.45	12.10

## Phone FM Transmitter Kit



This small circuit, when connected to a phone line, transmits both sides of a telephone conversation into the FM radio band in the 90-95MHz area. The phone line itself is used as an antenna. Includes all components and instructions.

#EN-320-067 ..... \$9<sup>95</sup> EACH

## 2 Stage FM Transmitter Kit



Easy to build and tune in the upper part of the FM band. Reaches over 1/2 mile (depending on conditions). Uses RF transistor for its final stage. Requires a 9V battery (not included). High quality PCB and components. Circuit schematic provided.

#EN-320-066 ..... \$10<sup>95</sup> EACH

## B & W CCD Board Cameras

Ultra miniature, high performance 1/3" CCD single board cameras feature a built-in 3.6mm wide angle lens and 400 lines of resolution. Requires a 12 VDC power supply (our #120-1100). Dimensions: 1-1/2" W x 1-3/4" H x 1" D.

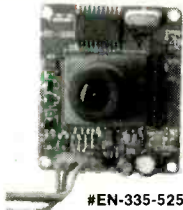

#EN-335-525



#EN-335-530

#EN-335-525 (Standard lens) ..... \$149<sup>95</sup> EACH

#EN-335-530 (Pin hole lens) ..... \$169<sup>95</sup> EACH

#EN-120-1100 (12VDC power supply) ..... \$7<sup>15</sup> EACH

**FREE CATALOG**  
**CALL TOLL FREE**  
**1-800-338-0531**



340 E. First St., Dayton, OH 45402-1257 ♦ Phone: 513-222-0173 ♦ Fax: 513-222-4644

♦30 day money back guarantee ♦\$20.00 minimum order ♦We accept Mastercard, Visa, Discover, and company C.O.D. orders ♦24 hour shipping ♦Shipping charge = UPS chart rate + \$1.90 (\$5.00 minimum charge) ♦Hours 8:00 am - 8:00 pm ET, Monday - Friday ♦9:00 am - 5:00 pm Saturday. Mail order customers, please call for shipping estimate on orders exceeding 5 lbs. ♦Foreign destination customers please send \$5.00 U.S. funds for catalog. ♦Quantity pricing available.

CIRCLE 262 ON FREE INFORMATION CARD

# VOICE CHANGERS! ELECTRONIC KITS AND MORE!

## ELECTRONIC KITS!

WE ACCEPT VISA, MC, MO, COD  
SHIPPING & HANDLING EXTRA



BUY WITH CONFIDENCE FROM XANDI

- 30-DAY REFUND POLICY
- TECH SUPPORT NUMBER (602-894-0992)

- Powerful 2 stage audio amplifier.
- Tunes 88-108 MHz.
- Up to 1 mile range.
- Requires 9V battery. (Not incl.)
- Sensitive, picks up sounds at the level of a whisper.



**SUPER-MINIATURE FM TRANSMITTER**  
Super small FM transmitter. Use with any FM broadcast receiver. Easy to assemble, all chip (SMT) parts are pre-assembled to the circuit board.

XST500 E-Z Kit ..... \$44.95

- Sensitive audio amplifier, picks up sounds at the level of a whisper.
- Tunes 88-108 MHz.
- Up to 1/2 mile range.
- Miniature photo battery mounts right on circuit board. (Included)



**MICRO-MINIATURE FM TRANSMITTER**  
Including the battery, this is the Worlds smallest FM transmitter. Use with any FM broadcast receiver. Easy to assemble, uses pre-assembled circuit board.

XWB1000 E-Z KIT ..... \$46.95

- Up to 1/2 mile range.
- Miniature photo battery mounts right on circuit board.
- Transmits at 143 MHz.
- Amazing audio sensitivity, picks up sounds at the level of a whisper.



**CRYSTAL CONTROLLED FM TRANSMITTER**  
Including the battery, this is the Worlds smallest crystal controlled FM transmitter. Transmits to any scanner type receiver. Easy to assemble, uses pre-assembled circuit board.

XTL1000 E-Z KIT ..... \$69.95

- Smallest Phone transmitter anywhere!
- Tunes 88-108 MHz.
- Up to 1/4 mile range.
- Attach to phone line anywhere in house.
- No batterie required, powered by phone line.



**SUPER-MINIATURE PHONE TRANSMITTER**  
Worlds smallest FM phone transmitter. Use with any FM broadcast receiver. Easy to assemble, all chip components are pre-assembled to the circuit board.

XSP250 E-Z Kit ..... \$28.95

- Dial your phone from anywhere and listen to the sounds inside your home.
- Two digit Touch Tone code for secure operation.



### TELEPHONE SNOOP

The latest in home or office security. Call home from anywhere, enter a two digit security code, and hear the sounds in your home. Automatically turns on without ringing the phone, verifies code, then activates for one and a half minutes.

XPS-CASE KIT ..... \$13.95

XPS1000 C KIT ..... \$55.95

- Transmits a continuous beeping tone.
- Adjustable from 88 to 108 MHz.
- Up to 1 mile range.
- Works with any FM broadcast receiver.



### TRACKING TRANSMITTER

Only 0.7 by 2.4 inches, the XTR100 operates at voltages of 3 to 18 Volts and is ideal for use in locating lost model rockets, bicycles, automobiles, games of hide and seek, and contests.

XTR100 C Kit ..... \$29.95

- Covers 1 to 2,000 MHz.
- Compact hand held unit.
- Uses sensitive microwave transistor amplifier.
- Includes miniature loud speaker for audio indication of detected signals.



### SUPER SENSITIVE BUG DETECTOR

When the XBD200 intercepts a signal in the 1 to 2,000 MHz range, it emits a growl that increases to a high pitched squeal as the signal strength increases.

XBD200 C Kit ..... \$39.95

- Use with any FM broadcast receiver.
- Hear every sound in an entire house!
- Up to 1 mile range.
- Powerful 2 stage audio amplifier.



### MINIATURE FM TRANSMITTER

The XFM100 has a super sensitive microphone and is capable of picking up sounds at the level of a whisper and transmitting them to any FM broadcast receiver.

XFM100 C Kit ..... \$21.95

- Digital voice changing: male to female, female to male, adult to child, child to adult.
- Anonymity on any call.
- Button for normal operation.
- 16 levels of voice masking.



### VOICE CHANGING TELEPHONE

STOP THOSE ANNOYING TELEPHONE CALLS! Sound older and tougher when you want to. Not a kit. Fully assembled. Single phone operation only.

TRANSITION 2000 ..... \$89.95

- Digital voice changing: male to female, female to male, adult to child, child to adult.
- Use with any modular phone.
- 16 levels of voice masking.
- Connects between handset and phone.



### VOICE CHANGING ACCESSORY

STOP THOSE ANNOYING TELEPHONE CALLS! Sound older and tougher when you want to. Not a kit. Fully assembled. Use with single or multi-line phones.

TRANSITION 2001 ..... \$59.95

- Uninterrupted coverage of 800 to 950 MHz.
- Works with any scanner that can receive 400 to 550 MHz.



### 800-950 MHz SCANNER CONVERTER KIT

If your scanner can receive 400-550 MHz, just add the XLC900 for uninterrupted 800-950 MHz coverage. It converts all 800-950 MHz signals down to 400-550 MHz so your scanner can receive them! Add our custom case kit for that "Professional" look.

XLC-CASE KIT ..... \$13.95

XLC900 C KIT ..... \$49.95

- Transmit high quality stereo to any FM stereo receiver.
- Built-in output level monitor for quick and easy tuning.
- Ideal for use with personal CD player.



### FM STEREO TRANSMITTER

Transmit full-bodied Hi Fi stereo to any FM stereo receiver. Separate left and right inputs and gain controls. Includes an output booster stage for greater range.

XFS-CASE KIT ..... \$13.95

XFS108 C KIT ..... \$39.95

**XANDI** Serving the public since 1981  
**ELECTRONICS, INC.**  
1270 E Broadway Rd. # 113, Tempe AZ 85282

**TOLL FREE ORDER LINE: 1-800-336-7389**  
**FAX LINE: 1-602-731-4748**  
**ASK FOR FREE CATAG OF OUR PRODUCTS**

**SEND MAIL XANDI ELECTRONICS**  
**ORDERS TO: BOX 25647**  
**TEMPE, AZ 85285-5647**

CIRCLE 279 ON FREE INFORMATION CARD

# The Source.



If you desire the best, most up-to-date information on sources for replacement electronic parts and technical literature, go right to the source: "The 1996 Consumer Electronics Replacement Parts Source Book."

This valuable annual publication, created by the Consumer Electronics Manufacturers Association (CEMA), a sector of the Electronic Industries Association (EIA), is the electronics manufacturing industry's most complete directory for obtaining replacement parts from product manufacturers. Includes information on obtaining the parts you need and where to find the current technical service literature that will help you better serve your customers. It's a manual no servicer can afford to be without. And, at just \$8, no one will have to. Get the book you need—right from the source.

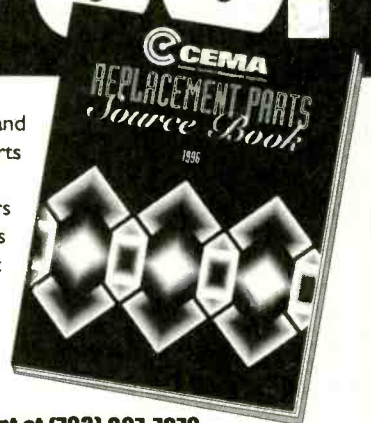

**To order your copy, or for more information, call the CEMA Product Services Department at (703) 907-7670.**



**Product Services Dept. EIA/CEMA, 2500 Wilson Blvd., Arlington, VA 22201**  
**Phone: (703) 907-7670 Fax: (703) 841-0030 Web Site: <http://www.eia.org>**

CIRCLE 326 ON FREE INFORMATION CARD

# U P P R O C E S S O R

T R A I N E R

The PRIMER 8085 Based Microprocessor Training and Control System takes you from writing simple programs to controlling motors. This trainer can be used stand alone via the keypad and display or connected to a PC with the optional upgrade (\$49.95). The Upgrade includes: an RS232 serial port, a serial cable, 32K of battery backed RAM and Assembler/Terminal software.

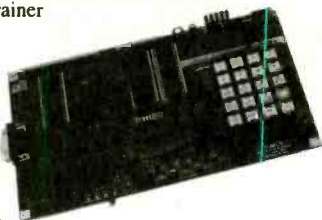

## EXPERIMENTS USING THE PRIMER INCLUDE

- Measuring Temperature
- Using a Photocell to Detect Light Levels
- Making a Waveform Generator
- Constructing a Capacitance Meter
- Motor Speed Control Using Back EMF
- Interfacing and Controlling Stepper Motors
- Scanning Keypads and Writing to LCD/LED Displays
- Using the Primer as an EPROM Programmer

The PRIMER is only \$119.95 in kit form. The PRIMER Assembled & Tested is \$169.95. Please add \$5.00 for shipping within the U.S. Picture shown with upgrade option and optional heavy-duty keypad (\$29.95) installed.

**ENAC, inc.**

P.O. BOX 2042, CARBONDALE, IL 62902  
618-529-4525 Fax 457-0110 BBS 529-5708

1985 - 1995

10  
YEAR  
ANNIVERSARY

**IN STOCK**

speed \ 'spɛd \ noun

- The art of moving swiftly in the performance of an action or undertaking  
syn. see Mouser Electronics

Call for your  
**FREE 324**  
page catalog  
TODAY!



61,601 Products  
120 Manufacturers  
All Orders Ship Same Day

- Passive Components ■ Semiconductors
- Electromechanical ■ Connectors/Cable
- Surface Mount and Through Hole

**MOUSER**  
ELECTRONICS

**800-992-9943**  
FAX: 817-483-0931  
<http://www.mouser.com>

958 North Main St., Mansfield, TX 76063

CIRCLE 329 ON FREE INFORMATION CARD



- PRODUCT ENGINEERING
- FIRMWARE DEVELOPMENT

- MICRO CONTROLLER & EPROM HARDWARE & SOFTWARE DEVELOPMENT

**"QUALITY IS OUR CAPITAL CONCERN."**

**Complete On Site  
Electrical Engineering Lab**

- REVERSE ENGINEERING
- RF CIRCUIT DESIGN & MANUFACTURING

From Auto-Routing to CNC Routing to Electronic Assemblies...  
**Capital Electronics is Your Best Route For Printed Circuit Boards.**

### DESIGN/LAYOUT

- CAD LAYOUT SERVICES
- COMPATIBLE WITH ALMOST ALL CAD SYSTEMS
- FROM SCHEMATICS OR SAMPLE PCB'S
- PHOTOPLOTTING SERVICES
- 28,800 BAUDE MODEM

### PRINTED CIRCUIT BOARDS

- SINGLE & DOUBLE SIDED
- MULTI-LAYER & FLEXIBLE PCB'S
- FROM QUICK TURN PROTOTYPES TO SCHEDULED PRODUCTION RUNS
- FINE LINES, SMT
- ELECTRICAL TESTING
- PRECIOUS METAL PLATING

### ASSEMBLY SERVICES

- FAST TURN BOARD STUFFING
- WIRE HARNESSES
- WAVE SOLDERING
- ACQUISITION OF PARTS
- FINAL TESTING
- TURNKEY SERVICES
- CUSTOM ENCLOSURES

**For Quick & Competitive Pricing or More Information,  
Please Call Us Today!**

852 Foster Avenue • Bensenville, IL 60106

**(708) 350-9510**

Fax (708) 350-9760 • Modem (708) 350-9761

### Internet Access:

For Automated Info Response:  
INFO@capital-elec.com  
E-Mail: Quote@capital-elec.com  
Web Access: <http://www.capital-elec.com>

CIRCLE 332 ON FREE INFORMATION CARD

**CALL TOLL FREE**  
**(800) 292-7711**  
**Se Habla Español**

**C&S SALES**  
**EXCELLENCE IN SERVICE**

**WRITE FOR A**  
**FREE 60 PAGE**  
**CATALOG!**



**M-6000**

**Features:**

- Computer Interface and Software with RS-232 Output
- Frequency to 4MHz
- Capacitance to 40nF
- Large 3 3/4 LCD display
- Temperature to 1999°F
- TTL logic
- Data/Peak hold
- Audible continuity
- Auto power off
- Unit indicator
- Diode Test

**NEW!**

**\$99.95**

**TK-3000**

**\$89.95**

**Tools Included:**

- SR-2 - Deluxe Soldering Iron
- SH-1 - Soldering Iron Stand
- ST-1 - Diagonal Pliers
- ST-2 - Long Nose Pliers
- ST-30 - Deluxe Wire Stripper
- SE-1 - Solder Ease Kit
- ND-3 - 3 pc. Nut Driver Set
- TL-8 - Precision Screw Drivers
- ST-5 - Screw Driver Slotted 3/16"
- ST-6 - Screw Driver #1 Phillips
- ET-10 - IC Puller
- SP-2 - Solder Pump
- ST-20 - Safety Goggles
- ST-9 - Pocket Screw Driver
- ST-4 - Solder Tube
- SW-3 - Solder Wick



**NEW!**

A professional technician service tool kit in a metal reinforced tool case with heavy-duty handle and locks. A removable pallet handles most of the tools listed with more room for tools and parts in the lower half.

**2MHz Function Generator**

**Model 4010**

- Sine, Square, Triangle, Pulse and Ramp output
- Variable duty cycle

**\$195.95**



**MX-9300 Four Functions in One**

- One instrument with four test and measuring systems: 1.3GHz Frequency Counter • 2MHz Sweep Function Generator Digital Multimeter • Digital Triple Power Supply (0-30V @ 3A, 15V @ 1A, 5V @ 2A)

**\$479.95**

**NEW**



**Model XP-581**

**4 Fully Regulated DC Power Supplies in One Unit**

- 4 DC voltages: 3 fixed - +5V @ 3A, +12V @ 1A, -12V @ 1A
- 1 Variable - 2.5 - 20V @ 2A

**\$85**



**Digital Multimeter Model EDM-83B**

**\$169**

18 Functions including freq to 20MHz, cap to 40µF, inductance to 40H, True RMS, Data Hold/min./max./avg., TTL logic.

**Digital Multimeter Model M-1700**

**\$42.95**

11 functions including freq to 20MHz, cap to 20µF. Meets UL-1244 safety specs.



**Fluke Multimeters**

**70 Series**

- Model 7011 ... \$69.95
- Model 7311 ... \$97.50
- Model 7511 ... \$135.00
- Model 7711 ... \$154.95
- Model 7911 ... \$175.00

**80 Series**

- Model 83 ... \$235
- Model 85 ... \$269
- Model 87 ... \$289

**B&K Precision Multimeters**

- Model 391 ... \$149
- Model 388A ... \$99
- Model 390 ... \$139
- Model 2707 ... \$79
- Model 389 ... \$109
- Model 2860A ... \$85

**Kit Corner**

over 100 kits available

**PT-223K**

**\$15.95**

Phone kit with training course.

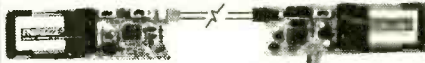

**Fiber Optics Technology with training course Model FO-30K**

**\$19.95**

**Model AM/FM-108K Transistor Radio Kit**

**\$29.95**



**M-1005K Compact Multimeter Kit**

6 Functions & Transistor Test

**\$19.95**



**XK-550 Digital / Analog Trainer**

Elenco's advanced designed Digital / Analog Trainer is specially designed for school projects. It is built on a single PC board for maximum reliability. It includes 5 built-in power supplies, a function generator with continuously sine, triangular and square wave forms. 1560 tie point breadboard area.

**XK-550 Assembled and Tested**

**\$169.95**

**XK-550K - Kit \$139.95**

Tools and meter shown optional



**WE WILL NOT BE UNDERSOLD**

**C&S SALES, INC.**

UPS SHIPPING: 48 STATES 5%  
 OTHERS CALL (\$5 min. / \$15 max.)  
 IL RES. 8% TAX

150 W. CARPENTER AVENUE  
 WHEELING, IL 60090  
 FAX: (847) 541-9904 (847) 541-0710



**15 DAY MONEY BACK GUARANTEE**  
**FULL FACTORY WARRANTY**  
 PRICES SUBJECT TO CHANGE WITHOUT NOTICE

CIRCLE 218 ON FREE INFORMATION CARD

**FREE PROBES  
WITH ALL  
SCOPES**

# OSCILLOSCOPES

Lowest Prices of the Year!

**WRITE FOR A  
FREE 60 PAGE  
CATALOG!**

Japan Quality  
But not Japan Prices!  
**Hitachi**  
Laptop Color  
Digital Scopes

**NEW!**  **NEW!**

150MHz 60MS/s VC-5460 \$3695  
50MHz 30MS/s VC-5430 \$2695  
20MHz 15MS/s VC-5410 \$1795

**100MHz**  
VC-6145 - Storage  
4 Channel 100MS/s ... **\$4795**  
VC-6155 - Storage 100MS/s \$3995  
VC-6545 - Storage 40MS/s \$2995  
V-1585 - 4 Channel ..... \$2095  
V-1565 w/ Cursors ..... \$1795  
V-1560 ..... \$1595

**50/60MHz**  
VC-6525 - Storage 20MS/s \$2795  
VC-6524 - Storage 20MS/s \$2295  
V-895 - 60MHz w/ Cursors \$1549  
V-555 - w/ Cursors ..... \$1095  
V-552 ..... \$949  
V-509 - Battery Operated . \$1795

**20MHz**  
VC-5025A - 20MS/s  
DSO w/ DMM ..... **\$1160**  
VC-5025 - 20MS/s  
DSO w/ DMM ..... **\$935**  
VC-8523 - Storage 20MS/s \$1995  
V-252 ..... \$449  
V-209 - Battery Operated . \$1425

## Quality Scopes by Elenco



**60MHz**

**DS-603 \$1350**

• Analog / Digital Storage

• 20MS/s Sampling Rate

**S-1365 \$795**

• Analog w/ Cursors

**S-1360 \$759**

• Analog with Delayed Sweep

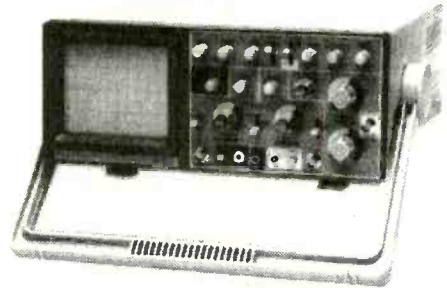

**40MHz**

**S-1345 \$569**

• Analog with Delayed Sweep

**S-1340 \$489**

• Analog

**25/30MHz**

**DS-303 \$1095**

• Analog / Digital Storage

**S-1330 \$439**

• 25MHz Analog

• Delayed Sweep

**S-1325 \$335**

• 25MHz Analog

**2 Year  
Warranty**

### OSCILLOSCOPE SELECTION CHART

ANALOG		Sensitivity (max)	No. of Channels	Sweep Rate Max ns/div	Delayed Sweep	Video Sync	Component Tester	Beam Find	Time Base
Model	Bandwidth MHz								
S-1385	60	1mV/div	2	10ns/div	Yes	Yes	Yes	Yes	2
S-1360	60	1mV/div	2	10ns/div	Yes	Yes	Yes	Yes	2
S-1345	40	1mV/div	2	10ns/div	Yes	Yes	Yes	Yes	2
S-1340	40	1mV/div	2	10ns/div	No	Yes	No	No	1
S-1330	25	1mV/div	2	10ns/div	Yes	Yes	Yes	Yes	2
S-1325	25	1mV/div	2	10ns/div	No	Yes	No	No	1
DIGITAL STORAGE		Analog Sen (max)	No. of Channels	Sampling Rate	Memory Channel	Internally Backed Up	Pretrigger %	Output	
Model	Bandwidth MHz								
DS-303	30	1mV/div	2	20MS/S	2K	Yes	0, 25, 50, 75	RS232	
DS-603	60	1mV/div	2	20MS/S	2K	Yes	0, 25, 50, 75	RS232	

### B&K Precision at Discount Prices

**20MHz Analog**

**2120 - \$389.95**

**2125 - \$539.95**  
Delayed Sweep

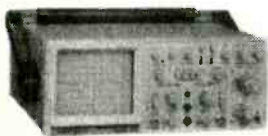

**Model 1541C**

**40MHz**

**\$695**

**Dual Trace**

**Model 2160**  
**60MHz Dual Trace**

**\$949**

Dual Time Base • Delayed Sweep

**60MHz with  
Cursors readouts  
and Dual Time Base**

**Model 2260**

**\$1225**

**Model 2190A**  
**100MHz 3 Channel**

**\$1379**

Dual Time Base • Delayed Sweep

### Fluke Scopemeters



91 ..... \$1225

92 ..... \$1525

96 ..... \$1795

97 ..... \$1795

97A ..... \$2945

99 ..... \$2095

Call or write for  
complete specs.

**WE WILL NOT BE UNDERSOLD**

**C&S SALES, INC.**

UPS SHIPPING: 48 STATES 5%  
OTHERS CALL (\$5 min. / \$15 max.)  
IL RES. 8% TAX

150 W. CARPENTER AVENUE  
WHEELING, IL 60090

FAX: (847) 541-9904 (847) 541-0710

CIRCLE 218 ON FREE INFORMATION CARD

**15 DAY MONEY BACK**

**GUARANTEE**

**FULL FACTORY WARRANTY**

PRICES SUBJECT TO CHANGE WITHOUT NOTICE

June 1996, Electronics Now

# MORE for LESS... Always!

**Best Values for Performance, Features and Dependability**

## DM5050C, 42 Range DMM + CAPACITANCE METER

- Digital Multimeter
  - Resistance - Up to 2,000 MΩ
- Capacitance Meter, Extended Range
  - Up to 20,000 μF (9 Range)
  - Zero Adjust Knob
  - Test Leads and Built-in Socket
  - Check Motor Starting & Running Capacitance
- Triggering Lamp

## DM5100, 45 Range WIDE RANGE, ELEVEN FUNCTION

- Auto Power Off, Data & Peak Hold
- Measures Wider Range
  - Frequency - Up to 20 MHz
  - Capacitance - Up to 200 μF
  - Resistance - Up to 200 MΩ
  - Current - Up to 20 A AC/DC
- Logic - TTL
- TRhFE

- ± 0.25% Basic DCV Accuracy
- 1.5" Big LCD Display
- 3 1/2 Digit Manual AC/DC Volt & Amp Resistance, Diode Continuity Beeper
- Alligator Clip Test Leads
- Double Insulated Jack
- Deluxe Holster
  - Lead Holders
  - Velcro Hanger
  - Tilt Stand



**\$89**

- Prices start at \$44.95, measuring AC/DC 10 Amp. & Volt, Resistance, more and including protective Holster
- Lots more High Standard Test Instruments available  
All in One Instrument, Oscilloscope, Power Supply, Function Generator, Freq. Counter, Multimeter, Capacitance, Engine Analyzer, Clamp-On, Electrical Tester and More.
- See your local distributors or Call for Catalog

**Bel MERIT**  
SOLUTIONS FOR THE TEST INSTRUMENT

26242 Dimension Dr., Suite 110  
Lake Forest, CA 92630  
(714) 586-3700 • FAX: (714) 586-3399

CIRCLE 297 ON FREE INFORMATION CARD

### ACTUAL SIZE B&W CCD BOARD CAMERA

3.6mm Adjustable manual focus or 5.5mm pin hole lens  
LATEST **SONY** HYPERHAD IMAGE SENSOR

PIN HOLE LENS ONLY NEEDS 1/16" HOLE TO SEE THROUGH

RESOLUTION: MORE THAN 380 LINES

MIN. ILLUMINATION: 0.4 LUX

SENSITIVE TO IR LIGHT

S/N RATIO: BETTER THAN 50DB (AGC OFF)

POWER: 9 - 13 VDC LESS THAN 150 MA

WILL RUN ON 9 VOLT BATTERY

BUILT-IN ELECTRONIC AUTO IRIS

SHUTTER SPEED: 1/60 - 1/50,000 SEC

VIDEO OUTPUT: 75 OHM, 2/1 INTERLACE

1.0 VOLT P/P COMPOSITE

CONNECTS TO ANY MONITOR OR VCR

- 1.5" SQ. HIDE THIS CAMERA IN PICTURES
- SMOKE DETECTORS
- THERMOSTATS
- LAMPS
- CLOCKS
- RADIOS

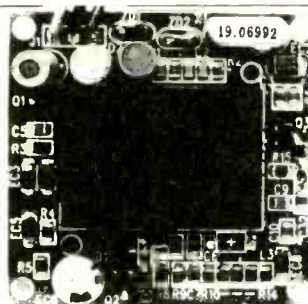

Plug in power supply	\$ 6.95
QTY 3.6mm PIN HOLE	
1-3	\$ 115.00 \$ 130.00
4-9	\$ 110.00 \$ 125.00

**BC ELECTRONICS**

1508 LEXINGTON • BEDFORD, TEXAS 76022  
PHONE (817) 267-7792 FAX (817) 283-7797

## LASERS & ACCESSORIES

WE SPECIALIZE IN  
**Laser and Laser Related Surplus Inventory**

### HE NE LASERS

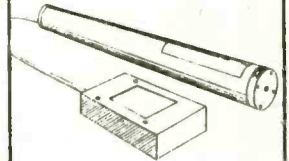

- Complete Systems
- Plasma Tubes
- Power Supplies

### DIODE LASERS



- Visible I/R
- Complete Modules
- Collimating Optics
- Drive Circuits

### ACCESSORIES

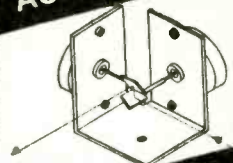

- Books
- Optics
- Electro-Optics

**CALL FOR A FREE CATALOG!**

We want your Laser related surplus items. Call or Fax us today for a quote!

**MEREDITH INSTRUMENTS**

P O Box 1724  
5035 N. 55th Ave. #5  
Glendale, AZ 85301

Phone: 602-934-9387  
Fax: 602-934-9482

[HTTP://WWW.MI-LASERS.COM](http://www.MI-LASERS.COM)

# PROGRAMMERS

- 1249 Advantech Labtool-48
- 696 EETools Allmax Plus
- 449 EETools Promax
- 539 EETools Megamax 4
- 429 Xeltek Superpro II
- 159 Xeltek Rommaster I
- 189 Xeltek Rommaster II
- 429 Needham EMP-20
- 689 Needham SA-20
- 589 MOD-MCT-EMUPA
- 350 MOD-MCT-EMUP-R
- 99 8Meg 1 Gang Eprom Programmer
- 140 8Meg 4 Gang Eprom Programmer
- 299 8Meg 8 Gang Eprom Programmer
- 39 Erasser 4 Chip - Add \$10 for Timer
- 79 Erasser 9 Chip With Timmer

## GENERAL DEVICE INSTRUMENT

Sales 408-241-7376 Email icdevice@best.com  
 Fax 408-241-6375 BBS 408-983-1234  
 WEB PAGE www.generaldevice.com

# BUY BONDS

# BUGGED??

**EAVESDROPPING** is unbelievably widespread! Electronic Devices with amazing capabilities can be monitoring your telephones and room conversations RIGHT NOW! Are you sure you're safe? **FREE CATALOG** tells you fast! Includes Free Bonus details on fantastic opportunities now open in Counter-Surveillance field. Exciting, immensely interesting and EXTREMELY profitable (up to \$250 hr) full/part-time income. Call Now!  
**1-800-732-5000**

# SURVEILLANCE

**The Latest High Tech Professional Electronic Devices**  
 Our latest catalog offers a **HUGE** selection of surveillance, privacy devices including: hidden video equipment, electronic kits, telephone recording systems, touch tone decoders, scanners, telephone tap detectors, bug detectors, voice disguisers, telephone scramblers, locksmithing tools, and more. **Catalog \$5.00.**

## SDY OUTLET

P.O. Box 337, Buffalo, NY 14226  
 (716) 691-3476/(716) 695-8660

# Prototype it..... FAST!

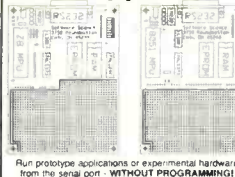

with ProtoQuick 8051 or Z8

- Complete single board computers
- Up to 32K EPROM and 8K RAM
- 17 bit in. parallel through serial ports
- RS232 C serial port w/ DTR/CTS control
- Op. sys. in EPROM w/ source code
- Assembled, ready to run. 5v only
- MS-DOS cross assembler included

ProtoQuick Z8 and 8051  
**\$99.00** each

Software Science  
 3750 Woodlawn Blvd.  
 Cincinnati, OH 45244 USA  
 (513) 561-2060

Run prototype applications or experimental hardware from the serial port - WITHOUT PROGRAMMING!

# Cable Aids Test

Orders Only Information  
**1-800-615-9221 Aids 407-998-7883**

Test Chips that fully activate Jerrold, Tocom, Zenith, SA, Pioneer and more. Quick-Board installation!  
 Prices from \$5 to \$49.95 ea. **MC SPECIALTIES**  
 1 Year Warranty!  
 No FL Sales. Not for use in cable co. owned equip. For test or repair only.

# CABLE TV DESCRAMBLERS



We Carry A Full Line Of Premium Converters And Descramblers Compatible With:

- Scientific Atlanta™ Systems
- Jerrold™ Systems
- Tocom™ Systems
- Zenith™ Systems
- Pioneer™ Systems

**SATISFACTION GUARANTEED OR YOUR MONEY BACK!**  
**BEST PRICES FREE CATALOG**  
 Please have the **MAKE & MODEL #** of your full premium service cable box ready when you call!

## ALLSTAR ELECTRONICS

**800-782-7214**

**HOURS: 9-6 M-F 10-3 Sat EST**

It is not the intent of Allstar Electronics to defraud any pay TV operator. Anyone implying theft of service will be denied assistance. All brand names are registered trademarks of their respective owners & are used for reference only. 110-64 Queens Blvd., #465, Forest Hills, NY 11375. NO NYS SALES!

# The GIANT Black Book of Computer Viruses

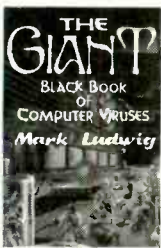

Enter the secret world of computer viruses with this incredible book! Find out how viruses work, while learning **coding secrets that make your computer software capable of amazing feats.** Explore the PC as well as Windows and OS/2 internals. Learn how to get a super user account on a UNIX system with

a virus. Get the inside scoop on the incredible KOH virus - a beneficial virus that will keep your data encrypted for you. More than just a dry textbook, this book is **an excellent tutorial in assembler** that will hold your interest with a fascinating subject! It includes **full source** and explanations of 37 different viruses and four different anti-virus programs!

**ALL NEW FOR 1996!** **672 page Book \$39.95**  
**Program Disk \$15.00**

Shipping \$3

**Call (800)719-4957 now!**

to order (Visa/MC/COD) or call or write for free catalog!

**American Eagle Publications, Inc.**  
 P. O. Box 1507  
 Show Low, AZ 85901

# Radiotelephone - Radiotelegraph

# FCC Commercial License

## Why Take Chances?

Discover how easy it is to pass the exams. Study with the most current materials available. Our **Homestudy** Guides, Audio, Video or PC "Q&A" disks make it so fast, easy and inexpensive. No college or experience needed. The new commercial FCC exams have been revised, covering updated Aviation, Marine, Radar, Microwave, New Rules & Regs, Digital Circuitry & more. We feature the Popular "Complete Electronic Career Guide". 1000's of satisfied customers **Guarantee** to pass or money back. Newest Q&A pools.

Send for **FREE DETAILS** or call

**1-800-800-7588**

**WPT Publications**  
 4701 N.E. 47th St.  
 Vancouver, WA 98661

Name \_\_\_\_\_

Address \_\_\_\_\_

City \_\_\_\_\_ St. \_\_\_\_\_ Zip \_\_\_\_\_

**1-800-800-7588**



Serving you since 1979

# JDR Microdevices

1850 South 10th Street, San Jose, CA 95112-4108

Expands for PLCC, PGA, QFP and Other Packages!

## Economically Program PLDs, EPROMs, MPUs and More!

This versatile system programs thousands of devices! Over 3,000 EPROMs, EEPROMs, microprocessors and programmable logic devices are supported. Adaptors are also available, allowing you to program PLCC, PGA or other package styles.

Over 3,000 devices supported, including these popular families:

PIC16	8751
22V10	8749
16V8	20CG10AP
27C256	82S131
27C401	27C101
68HC705	68HC11
TMS2532	28F020

# ONLY \$499

Call Toll-FREE 1-800-538-5000 for Your FREE Catalog!

Programs Over 3,000 Devices!

### MODULAR CIRCUIT TECHNOLOGY

For an up-to-date list of supported devices, call our BBS at 1-408-494-1430 and download EMUPLIST.3IP

A menu-driven shell makes programming easy! Select appropriate programming options with easy-to-use single-keystroke entries. A front-panel switch eliminates the need to return to the keyboard.

The software includes 2 and 4-way split and shuffle capability for 16 and 32-bit code, hex and extended hex file conversion and more. You can even write test vectors directly to test your PLD designs!

- Programs DIP EPROMs, EEPROMs, PROMs, PALs, GALs, PEELs, EPLDs, FPLs, MPUs and more without additional software
- PLCC, PGA and other packages supported using appropriate adaptors, 4-gang adaptors program multiple devices simultaneously
- Front panel switch and LED status indicators allow you to respond without returning to the keyboard
- Complete with 8-bit PC compatible ISA card and cable

MOD-EMUP-A 3 lbs ..... \$499.00



Easy-to-use software requires minimal keystrokes!

PLCC, QFP, ZIP, 4-Gang and other adaptors available!

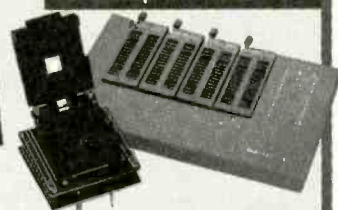

## Call 1-800-538-5000

Internet Orders <http://www.jdr.com>

Toll-Free Fax Ordering Local/International  
1-800-538-5005 1-408-494-1400

Order 24-Hours-A-Day By Phone or Fax

TERMS: For shipping & handling include \$4.29 for ground & \$6.99 for 2nd day air. Orders over \$10. and foreign orders may require additional shipping charges—contact our Sales Dept. for the amount. CA residents must include applicable sales tax. Prices subject to change without notice. We are not responsible for typographical errors. We reserve the right to limit quantities and to substitute manufacturers. All merchandise subject to prior sales. A full copy of our terms to minimize upon request. Items purchased may only be returned to JDR, the JDR logo, JDR Microdevices, and the MCT logo are registered trademarks of JDR Microdevices. Modular Circuit Technology is a trademark of JDR Microdevices. Copyright 1996 JDR MICRODEVICES. Other trademarks are the property of their respective owners.



## WE SELL RED, BLUE-GREEN & IR

# LASERS

### HUNDREDS OF UNITS TO CHOOSE FROM! PRICES AS LOW AS \$40.00!

- Experiments
- Laser Light Shows
- Cutting & Burning
- Communications

We also carry books and plans about LASERS.

### CALL FOR FREE CATALOG!

TEL (909) 278-0563

FAX (909) 278-4887

## MWK INDUSTRIES

1269 W. Pomona, Corona, California 91720

See our catalog on the internet.

[HTTP://WWW.PWEB.COM/MWK/MAIN.HTM](http://www.pweb.com/mwk/main.htm)

EMAIL: [MKENNY1989@AOL.COM](mailto:MKENNY1989@AOL.COM)

## CONTROL

RELAYS • LIGHTS • MOTORS

## MEASURE

TEMPERATURE • PRESSURE • LIGHT LEVELS • HUMIDITY

## INPUT

SWITCH POSITIONS • THERMOSTATS • LIQUID LEVELS

MODEL 30 ..... \$79



- PLUG INTO PC BUS
- 24 LINES DIGITAL I/O
- 8 CHANNEL
- 8 BIT A/D / IN
- 12 BIT COUNTER
- UP TO 14K BMP/SEC

MODEL 45 ..... \$189



- RS-232 INTERFACE
- 6 DIGITAL I/O
- 8 ANALOG INPUTS
- 2 ANALOG OUTPUTS
- 2 COUNTERS-24 BIT

MODEL 100 ..... \$279



- 12 BIT 100 KHZ A/D
- 4 ANALOG OUTPUTS
- 3 TIMER COUNTERS
- 24 DIGITAL I/O

MODEL 60 ..... \$179



- 8 2-AMP RELAYS
- 16 DIGITAL I/O
- 1 8-BIT ANALOG INPUT

MODEL 40 ..... \$99

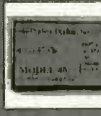

- RS-232 INTERFACE
- 28 LINES DIGITAL I/O
- 8 ANALOG INPUTS
- PWM OUTPUT
- OPTIONAL 12 BIT A/D

MODEL 70 ..... \$239

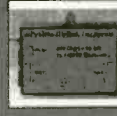

- RS-232 INTERFACE
- 18 BIT A/D
- 5.5 DIGIT
- UP TO 60 BMP/SEC

NEED A CUSTOM PCB? TRY US.

## PRAIRIE DIGITAL, INC.

PHONE 608-643-8599 • FAX 608-643-6754

846 SEVENTEENTH STREET • PRAIRIE DU SAC, WISCONSIN 53578

CIRCLE 328 ON FREE INFORMATION CARD



# Satellite TV 'BIBLE'

## 4th 'DIGITAL' edition

The acclaimed 'bible' of satellite TV  
- ALL the TECHNICAL DETAILS -

- Operation, installation & troubleshooting of analog and digital satellite systems
- The transition from analog to digital TVRO

**1-800-483-2423**

TO ORDER

or for a FREE books/software/video CATALOG

HOME SATELLITE TV  
INSTALLATION  
AND TROUBLESHOOTING  
MANUAL  
4th Edition



324 pages  
8-1/2" x 11"  
\$30 plus \$4 s/h

Baylan Publications

1905 Mariposa, Boulder, Colorado 80302, USA  
Telephone: 303-449-4551 FAX: 303-939-8720

# ELECTRONIC SHOPPER

# HOME AUTOMATION

Largest Selection of HOME AUTOMATION products in the World!

Browse us on the WEB!

<http://www.techmall.com/smarthome>

Hundreds of hard-to-find automation, X10, and wireless control products. Computer control of your home, security systems, surveillance cameras, infra red audio/video control, HVAC, pet care automation, wiring supplies, and much more!

**HOME AUTOMATION SYSTEMS, INC.**

151 Kalmus Drive, Ste L4, Costa Mesa, CA 92626  
Questions 714-708-0610 FAX 714-708-0614

HOME AUTOMATION SYSTEMS, INC.



**FREE**

**800-SMART-HOME**

800-762-7846

Call 24hrs for FREE  
64 page Color Catalog  
Over 500  
unique products!

## Invest a stamp...Save a bundle

For the price of a stamp, you can get the latest edition of the federal government's free Consumer Information Catalog. It lists more than 200 free or low-cost publications on federal benefits, jobs, health, housing, education, cars, and more.

So stamp out ignorance with our free Catalog. Send your name and address to:  
Consumer Information Center, Department SB, Pueblo, Colorado 81009

### EZ-EP DEVICE PROGRAMMER - \$169.95

**Fast** - Programs 27C010 in 23 seconds.

**Portable** - Connects to PC Parallel Port.

**Versatile** - Programs 2716-080 plus EE and Flash (28F,29C) to 32 pins

**Inexpensive** - Best for less than \$200

- Correct implementation of manufacturer algorithms for fast, reliable programming.
- Easy to use menu based software has binary editor, read, verify, copy, etc. Free updates via bbs or web page.
- Full over current detection on all device power supplies protects against bad chips and reverse insertion.
- Broad support for additional devices using adapters.

#### Adapters Available

EP-51 (8751,C51)	\$39.95
EP-11 (68HC11 EA)	\$59.95
EP-PIC (16C5X,61,62X,71,84)	\$49.95
EP-PIC64 (16C62,63,64,65,73,74)	\$39.95
EP-PEEL (ICT 22V10, 20G10, 16V8)	\$59.95
EP-SEE (93X,24X,85X)	\$34.95
EP-16 (16bit 40 Pin EPROMs)	\$49.95
EP-49 (8742, 48, 49)	\$49.95
EP-750 (87C750,751,752)	\$59.95
EP-Z8 (Z86E03,04,05,06,07)	\$39.95
EP-55 (8755)	\$39.95
EP-51-PLCC (8751,C51)	\$59.95
EP-PIC-SOIC (16C5X,61,62X,71,84)	\$59.95
EP-PLCC (PLCC EPROMs)	\$49.95
EP-SOIC (SOIC EPROMs)	\$49.95
EP-LCC (LCC EPROMs)	\$49.95

#### M'L Electronics

3526 Jasmine #4; Los Angeles, CA 90034

310/837-7818 Fax/BBS: 310/841-6050

<http://www.cs.ucla.edu/csod-grads-gs3/aving/www/m21.html>

CA orders add 8.25% sales tax. Ground shipping - \$5; 3 Day - \$7; 2 Day \$10; Overnight \$17; COD \$4.75.

**EZ-EP**  
M'L ELECTRONICS

Los Angeles, California (310) 327-7312

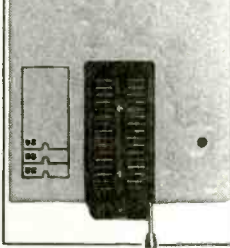

## MEMBRANE SWITCH KITS!

FLAT PANEL KEYPADS  
ASSEMBLE IN  
MINUTES WITH YOUR  
LEGEND

AVAILABLE IN 4, 12,  
16, 24 & 40 KEY TYPES



DSK-4  
\$9.89

CONNECTOR  
AND BEZEL  
INCLUDED!  
  
OPTIONAL  
"CLICKDOMES"  
AVAILABLE

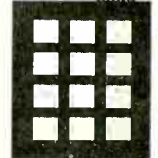

DSK-12  
\$14.29

## INDUSTRIAL TYPES AVAILABLE

MORE THAN 30 LAYOUTS  
TO FIT MOST  
APPLICATIONS

CALL FOR FREE  
BROCHURE

## SIL-WALKER

880 CALLE PLANO,  
UNIT N  
CAMARILLO, CA  
93012

PHONE: (805) 389-8100

FAX: (805) 484-3311

VISA / MASTERCARD

## CABLE CONVERTERS/DESCRAMBLERS

★ ★ ★ ★ SUPER BUYS ★ ★ ★ ★  
★ FULLY REFURBISHED UNITS ★

TOCOM™ ★ JERROLD™ ★ SCIENTIFIC ATLANTA™ ★ ZENITH™ ★ PIONEER™  
"WE SERVICE MOST PRIVATELY OWNED CABLE CONVERTERS"

Phone (219) 935-4128



SORRY, NO INDIANA SALES

## NATIONAL CABLE BROKERS

1801 W. JEFFERSON ST., PLYMOUTH, IN 46563

OUR POLICY: All products carry a two year warranty. Warranty covers parts and labor and return shipping.  
WARNING: Theft of cable services is a crime. National Cable will not knowingly defraud any pay TV operator and we will not assist any individual or company in doing the same.

**New! Tiny One Ounce Video Camera, Under \$100!**

**"Supercircuits has the biggest selection of cutting edge video cameras & video transmitters I've ever found...many are just plain AMAZING!"**

- Dave Klingerman, Olde Antenna Labs

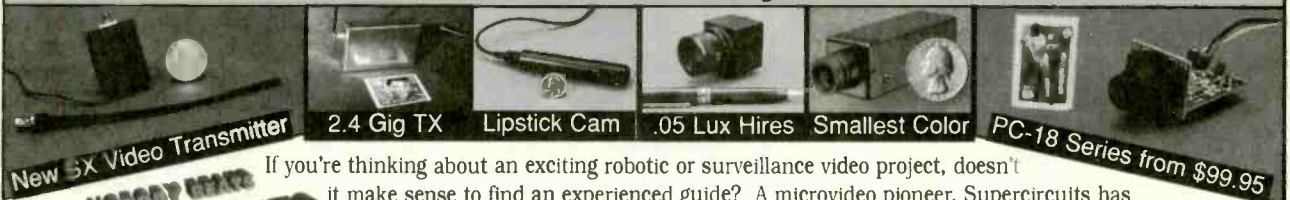

New 5X Video Transmitter

2.4 Gig TX

Lipstick Cam

.05 Lux Hires

Smallest Color

PC-18 Series from \$99.95

**SUPERCIRCUITS**

If you're thinking about an exciting robotic or surveillance video project, doesn't it make sense to find an experienced guide? A microvideo pioneer, Supercircuits has the most advanced microvideo transmitters and cameras at the lowest prices. In fact, Supercircuits microvideo is used by the DEA, CIA, FBI, Air Force, Army, Navy, NASA and many others. But with prices starting at under \$100 for tiny high resolution video cameras that Video Magazine recently gave 5 star ratings in a hands-on test, it is truly technology that is as affordable as it is amazing. Call us today, or send \$5.00 (refundable) for our 50 page Microvideo Catalog, loaded with photos, configurations, specs & more. Please visit our award winning website at [www.scx.com](http://www.scx.com).

**SUPERCIRCUITS** Call Us Today! **1-800-335-9777 ext.4011**

One Supercircuits Plaza, Leander, Texas 78641

**CABLE TV DESCRAMBLERS  
LEGALIZED ! BUY DIRECT FROM  
THE MANUFACTURER. \$250.00**

**THE MOST SOPHISTICATED 1 PIECE SYSTEM ON THE  
MARKET! 11 EXTRA FEATURES • REMOTE CONTROL •  
SLEEP TIMER • PARENTAL  
LOCK OUT • FAVORITE  
CHANNEL PROGRAMMING  
AND MORE!  
MONEY BACK GUARANTEE  
LOWER PRICE SYSTEMS  
AVAILABLE**



**CALL NOW! 1-800-555-1651**



One tree can make  
3,000,000 matches.



One match can burn  
3,000,000 trees.



A Public Service of This Magazine  
& The Advertising Council



**PUT YOUR PC TO WORK**

**THIS IS THE DREAM MACHINE YOU'VE BEEN WAITING FOR**

**2.5, 3, & 4 AXIS CNC/DNC  
DESKTOP MANUFACTURING UNITS**

STARTING AT  
**\$495.00**



- AUTOMATICALLY PROTOTYPE PC BOARDS & MACHINE 3D PARTS FROM CAD
- CARVE, ROUTE, MILL, & DRILL WOOD, PLASTICS, & LIGHT METALS
- FREE POWERFUL 3D CAD/CAM SOFTWARE WITH EACH UNIT
- INEXPENSIVE CNC KITS AND ASSEMBLED CNC UNITS
- NOW OVER 20 DIFFERENT MODEL-OPTIONS
- EXPEDITE & SUPER-EXPEDITE AVAILABLE



SIZES FROM 12"x 12"  
TO HUGE 6'x 6' UNITS

ORDER NOW! 501-839-8293 U.S. CYBERLAB, INC., 14786 SLATE GAP ROAD, WEST FORK, AR 72774

**CALL NOW FOR INSTANT SPECS 501-839-8293 24 HR. FAX-BACK SERVICE**

## 68HC11 and other PLCC prototype adapters

that fit on a single breadboard strip!

PLCC sockets mounted on PCB with .25" leads



Patent-pending design for wire wrap, design prototyping & breadboarding

28 Pin-\$ 6.95, 44 Pin-\$ 9.49, 52 Pin-\$ 13.49, 68 Pin - \$ 14.95, 84 Pin-\$ 18.95. All + S/H. Visa/MC/Check

### AMAZE ELECTRONICS CORP.

Tel: 408-996-8943 Fax: 408-996-0366  
amaze@hooked.net www.hooked.net/users/amaze

## CABLE TV CONVERTERS

Equipment & Accessories  
Wholesalers Welcome

Call VISION TIME PRODUCTS

1-800-310-1153 M-F 8a-8p

NO TENN SALES

## VIDEO SYNC GENERATOR



Restores Horizontal and Vertical Sync Lines from Distorted Analogue Video Formats

For Free Information Package on Completed Units and Pricing

• Call Toll Free •

1-800-236-5778

R.C. Distributing • PO Box 552 • South Bend, IN 46624

## Smart Battery Charger



JUN 87 QST

BY WARREN DION N1BBH

FOR GEL-CELLS or LEAD ACID BATTERIES.  
Features: Precision temperature tracking voltage reference & three mode charging sequence. Standard kit is for 12V @ 1/2 or 1 Amp, user selectable. Can be connected to the battery indefinitely, will not overcharge. Weighs 2 pounds and measures 4"W x 5 1/2"D x 2 1/2"H. Finished enclosure included in kit.

Complete Kit Only ..... \$59.95  
Assembled & Tested ..... \$79.95

CA Residents add 7.75% sales tax. S&H: \$5.00 (Insured). Foreign orders add 20%. For more info or price list, send legal size SASE (52¢) to:

**A&A Engineering**

2521 W. La Palma #K • Anaheim, CA 92801  
(714) 952-2114 • FAX: (714) 952-3280

## CABLE TV

ALL NAME BRANDS

DESCRAMBLERS, CONVERTERS

COMBOS. CALL NOW

WE'LL BEAT THE COMPETITION.

UNIVERSAL SALES 800-647-2371

## OUR LOWEST PRICES!

### B&K 20MHz Dual Trace Oscilloscope

Probes Included

- 1 mV/div sensitivity
- AUTO/NORM triggered sweep operation
- AC, TVH, TVV and line coupling
- Calibrated 19 step time base with x-10 magnifier

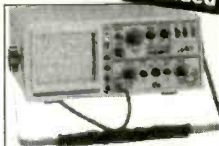

model #2120 2 Year Warranty ..... 385.00

model #2125 w/delayed sweep ..... 529.95

model #2190A 100MHz 3 Ch ..... 1339.95

### Call For Free! 40 Page Catalog

#### Pinhole Camera

- Requires 1/16" opening size
- 1-1/2" x 1-1/2" x 7/8"
- Power 7.5-12VDC n
- 8 lux
- 3.8mm lens included
- 380 lines resolution
- 12V DC Power Supply 9.95

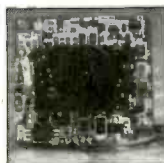

model #CVC50PH ..... 139.95

### Protek Test Equipment

#### 20 MHz Oscilloscope Dual Trace w/ Component Checker

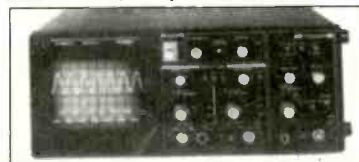

#P3502C Dual Trace ..... 375.95

#P2510 100 MHz 3 Ch. 8 Trace ..... 1195.00

**Cutting Edge** The model 506 meter has a RS-232C serial interface. Measured values are transmitted to the computer via an interface cable and supplied software WINDOWS and MS-DOS.  
DCV 1000V ACV 1000V AC/DC Current 20A  
Res. 40 meg Ω freq. 10MHz  
REG. 189.95

model #506 ..... 169.95

#### Metal Detector Wand by Garrett

model #MD1 Special 145.95



#### Elenco Digital Capacitance Meter

- 1 UF to 20,000 UF
- Banana jack and special insertion jack Included

model #CM-1555

49.95

Call For FREE Catalog & Technical Assistance

Add \$8.95 Shipping/Handling  
NYS Add Tax  
Visa/MC/Discover/Amex

MAIL ORDERS TO :  
70 CAIN DR.  
BRENTWOOD, NY 11717



**ALL PHASE**  
VIDEO-SECURITY INC.  
WHOLESALE VIDEO WAREHOUSE

1-800-945-0909

FAX: 516-435-7494

## FREE HOME AUTOMATION CATALOG!



Home Controls' color catalog features truly affordable X-10 powerline controls, IR products, CCD cameras, wireless home control devices, security products, drapery controls, audio systems, and everything you can imagine for the remote and automated control of your home!

Call Toll Free  
**1-800-CONTROL**

Contact us by E-Mail: [homectrl@electriciti.com](mailto:homectrl@electriciti.com)

Lowest Prices Guaranteed • Same Day Shipping • Superior Technical Support  
No Minimum Order • Fabulous Freebies • Great Selection!



## 1-CHIP MICROCONTROLLER TRAINER

PARTS KIT INCLUDING:

- Programmed Motorola 68705P3 (only 1 IC required)
- Display 1 X 16 AlphaNumeric LCD
- Keypad 5 X 4
- 4 MHz clock oscillator, reset switch, R, C

MANUAL - experiments & programming - 224 pgs.

\$89 plus shipping  
VISA, MC, COD CA residents add CA sales tax

Just Add Wire And +5VDC To Get Started

**SQUARE 1**  
ELECTRONICS

P.O. Box 501, Kelseyville, CA 95451  
Order (800) 220-3916  
Support (707) 279-8881  
FAX (707) 279-8883  
Hours 7AM-12N, 1-4PM Pacific M-F

CIRCLE 232 ON FREE INFORMATION CARD

# USE ELECTRONICS NOW CLASSIFIEDS

READ BY ELECTRONIC BUYERS AND SELLERS AND TRADERS

## INSTRUCTIONS FOR PLACING YOUR AD!

### HOW TO WRITE YOUR AD

**TYPE** or **PRINT** your classified ad copy **CLEARLY** (not in all capitals) using the form below. If you wish to place more than one ad, use a separate sheet for each additional one (a photo copy of this form will work as well). Place a category number in the space at the top of the order form (special categories are available). If you do not specify a category, we will place your ad under miscellaneous or whatever section we deem most appropriate.

We cannot bill for classified ads. **PAYMENT IN FULL MUST ACCOMPANY YOUR ORDER.** We do permit repeat ads or multiple ads in the same issue, but in all cases, full payment must accompany your order.

### WHAT WE DO

The first word and company name of each ad are set in bold caps at no extra charge. No special positioning, centering, dots, extra space, etc. can be accommodated.

### RATES

Our classified ad rate is \$2.50 per word. Minimum charge is \$37.50 per ad per insertion (15 words). Any words that you want set in bold are each .40 extra. Indicate bold words by underlining. Words normally written in all caps and accepted abbreviations are not charged anything additional. State abbreviations must be post office 2-letter abbreviations. A phone number is one word.

If you use a **Box** number you must include your permanent address and phone number for our files. **ADS SUBMITTED WITHOUT THIS INFORMATION WILL NOT BE ACCEPTED.**

For firms or individuals offering Commercial products or Services. **Minimum 15 Words.** 5% discount for same ad in 6 issues within one year; 10% discount for same ad in 12 issues. **Boldface** (not available as all caps), add .40 per word additional. **Entire ad in boldface**, add 20%. **Tint screen behind entire ad**, add 25%. **Tint screen plus all boldface ad**, add 45%. **Expanded type ad**, add \$4.00 per word.

**General Information:** A copy of your ad must be in our hands by the 13th of the fourth month preceding the date of issue (i.e. Sept issue copy must be received by May 13th). When normal closing date falls on Saturday, Sunday or Holiday, issue closes on preceding work day. Send for the classified brochure.

### DEADLINES

Ads not received by our closing date will run in the next issue. For example, ads received by November 13 will appear in the March issue that is on sale January 17. **ELECTRONICS NOW** is published monthly. No cancellations permitted after the closing date. No copy changes can be made after we have typeset your ad. **NO REFUNDS**, advertising credit only. No phone orders.

### CONTENT

All classified advertising in **ELECTRONICS NOW** is limited to electronics items only. All ads are subject to the publishers' approval. **WE RESERVE THE RIGHT TO REJECT OR EDIT ALL ADS.**

**AD RATES:** \$2.50 per word, Minimum \$37.50

Send you ad payments to:

**ELECTRONICS NOW 500 Bi-County Blvd, Farmingdale, NY 11735-3931**

### CATEGORIES

100 -- Antique Electronics	270 -- Computer Equipment Wanted	450 -- Ham Gear Wanted	630 -- Repairs-Services
130 -- Audio-Video Lasers	300 -- Computer Hardware	480 -- Miscellaneous Electronics For Sale	660 -- Satellite Equipment
160 -- Business Opportunities	330 -- Computer Software	510 -- Miscellaneous Electronics Wanted	690 -- Security
190 -- Cable TV	360 -- Education	540 -- Music & Accessories	710 -- Telephone
210 -- CB-Scanners	390 -- FAX	570 -- Plans-Kits-Schematics	720 -- Test Equipment
240 -- Components	420 -- Ham Gear For Sale	600 -- Publications	730 -- Wanted

### CLASSIFIED AD COPY ORDER FORM

Place this ad in Category # \_\_\_\_\_ Special Category \$30.00 Additional \_\_\_\_\_

1 - \$37.50	2 - \$37.50	3 - \$37.50	4 - \$37.50	29 - \$72.50	30 - \$75.00	31 - \$77.50	32 - \$80.00
5 - \$37.50	6 - \$37.50	7 - \$37.50	8 - \$37.50	33 - \$82.50	34 - \$85.00	35 - \$87.50	36 - \$90.00
9 - \$37.50	10 - \$37.50	11 - \$37.50	12 - \$37.50	37 - \$92.50	38 - \$95.00	39 - \$97.50	40 - \$100.00
13 - \$37.50	14 - \$37.50	15 - \$37.50	16 - \$40.00	Total words _____		\$2.50 per word = \$ _____	
17 - \$42.50	18 - \$45.00	19 - \$47.50	20 - \$50.00	Bold Face _____		\$0.40 per word = \$ _____	
21 - \$52.50	22 - \$55.00	23 - \$57.50	24 - \$60.00	Special Heading _____		\$30.00 = \$ _____	
25 - \$62.50	26 - \$65.00	27 - \$67.50	28 - \$70.00	Other _____		= \$ _____	

Total classified ad payment \$ \_\_\_\_\_ enclosed **TOTAL COST OF AD \$ \_\_\_\_\_**

Check  Mastercard  Visa  Discover Card # \_\_\_\_\_ Expiration Date \_\_\_\_/\_\_\_\_/\_\_\_\_

Signature \_\_\_\_\_

Name \_\_\_\_\_ Phone \_\_\_\_\_

Address \_\_\_\_\_ City State Zip \_\_\_\_\_

**"NOW BUYING"**  
**\$\$ BEST PRICES \$\$**  
**AVAILABLE**

<b>SCIENTIFIC ATLANTA™</b> 8536 THRU 8600	<b>PIONEER™</b> 5135 THRU 6300
<b>ZENITH™</b> 1086 THRU 1612	<b>JERROLD™</b> DPV7 DPBB7 DPV70 DPBB70 CFT
<b>TOCOM™</b> 5503A VIP THRU 5507	

**Midwest's Largest Brokers**  
*(We buy quantities of one to one thousand units)*

**NATIONAL CABLE BROKERS**  
**(219) 935-4128**

**16 Bit Control**

& Data Acquisition System

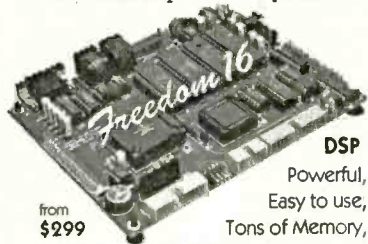

from \$299

DSP  
Powerful,  
Easy to use,  
Tons of Memory,

I/O & features:

- 16.8MHz 68HC16
- RS-232 & RS-485
- RT clock option
- 34 digital I/Os (7 IRQ)
- + LCD/Keypad port
- + 8 ch 10b fast A/D

Affordable "C" compiler/library  
 Multi-tasking kernel  
 Up to 256K ea. SRAM, FLASH memory

**INTEC INOVENTURES INC.**

Ph: (604) 721-5150 FAX: 721-4191

**Printed Circuits in Minutes Direct From LaserPrint!**

8 1/2" x 11"  
 \* Or Photocopy  
 \*\*Use standard household Iron or P-n-P Press.

1. LaserPrint\*
2. Press On\*\*
3. Peel Off
4. Etch



Use Standard Copper Clad Board  
 20 Shts \$30/ 40 Shts \$50/ 100 Shts \$100  
 Visa/MC/PO/Ck/MO \$4 S&H

Techniks Inc.  
 P.O. Box 463  
 Ringoes NJ 08551  
 ph. 908.788.8249 fax 908.788.8837  
<http://chelsea.los.com/~techniks>  
 Retail Dealer Inquires Invited

**HIGH POWER AUDIO AMPLIFIER CONSTRUCTION**

High Power Audio Amplifier Construction

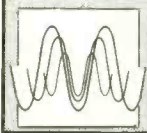

**BP277**—Here's background and practical design information on high power audio amplifiers capable of 300±400 watts r.m.s. You'll find MOSFET and bipolar output transistors in inverting and non-inverting circuits. To order your copy send **\$6.25 plus \$3.00** for shipping in the U.S. and Canada to **Electronic Technology Today Inc., P.O. Box 240, Massapequa Park, NY 11762-0240**. U.S. and Canada only. Payment in U.S. funds by US bank check or International Money Order. Please allow 6-8 weeks for delivery.

MA03

**BASIC PROGRAMMABLE CONTROLLER APPLICATION READY!**



**ONLY \$279.95**

**FEATURES:** complete real world interface • plug on I/O connectors • 10 power relay outputs • 16 isolated inputs • 3 LED outputs • 8 ch 10 bit A/D • 2 ch 8 bit D/A • 80C552 micro • 14.7 Mhz clock speed • 32 K battery SRAM • 32 K ROM • RTC • I2C expansion bus • RS232/485 serial port • full two-way X10 communication with optional controller • single 12 Vdc operation • complete line of I/O expansion boards

**APPLICATIONS:** Industrial control • HVAC Systems • home automation X10 controller • security • data logging • remote control & monitoring

**SYLVA Control Systems** a division of Sylva Energy Systems Inc.

519 Richard Street, Thunder Bay, Ontario, Canada P7A 1R2

Ph. 807-683-6795 Fax 807-683-6485 BBS 807-767-0587

WEB PAGE: <http://www.sylvacontrol.baynet.net>

Email: [sylva@mail.baynet.net](mailto:sylva@mail.baynet.net)

**UPGRADE YOUR COMPUTER!**

**TECHNOLOGY ASSOCIATES**

950 W. 5th St. • Reno, NV 89503 • (702) 323-4875 • Fax (702) 324-3900  
[www.techass.com](http://www.techass.com) • [sales@hoopsware.com](mailto:sales@hoopsware.com)  
 VISAMC Welcomed

<p><b>Memory</b></p> <p>1Mb (1x6-70 ns) \$18                  4Mb (4x6-70 ns) \$75                  4Mb (1x32-60 ns) \$62                  8Mb (2x32-60 ns) \$116                  16Mb (4x32-60 ns) \$263</p>	<p><b>CPUs</b></p> <p>Cyrix 486DX2-60 \$20                  AMD 486DX2-80 \$40                  AMD 486DX4-100 \$60                  AMD 486DX4-133 \$74                  Cyrix 586-120 \$102                  Intel Pentium 75 \$108                  Intel Pentium 100 \$204                  Intel Pentium 120 \$250                  Intel Pentium 133 \$327                  Intel Pentium 150 \$432                  Intel Pentium 166 \$640</p>	<p><b>Motherboards</b></p> <p>486SX-40 w/CEU \$68                  486xx VLB 256K \$89                  486xx PCI 256K \$101                  Pentium soa. Intel Triton 256K pipeline \$140</p>
<p><b>Hard Drives</b></p> <p>IDE                  WD 635Mb IDE \$180                  WD 850Mb IDE \$184                  Seagate 1.0Gb IDE \$204                  WD 1.2Gb IDE \$224                  WD 1.6Gb IDE \$272</p> <p>SCSI                  Quantum 1.05Gb SCSI \$184                  Quantum 1.08Gb SCSI \$240                  Conner 1.08Gb SCSI2 \$268</p>	<p><b>Video Cards</b></p> <p>256K ISA SVGA \$23                  Trident 8900 1Mb ISA SVGA \$60                  Trident 9440 1Mb VLB SVGA \$64                  Trident 9440 1Mb PCI SVGA \$64</p>	<p><b>Modems</b></p> <p>14.4 Int Fax/Modem \$44                  14.4 Int Fax/Modem w/Voice \$64                  14.4 Ext Fax/Modem w/Voice \$68                  28.8 Super Exp Int PNP Fax/Modem \$114                  28.8 Int Fax/Modem w/Voice \$142</p>
<p><b>Sound Cards</b></p> <p>16-bit Sound Blaster Pro compatible \$45                  16-bit SB Pro comp plug-n-play \$83                  Sound Blaster AWE32 \$138</p>	<p><b>Controller Cards</b></p> <p>ISA MIB I/O IDE FDC 25/1P/1G \$15                  VLB MIB I/O, EIDE FDC 25/1P/1G \$18                  VLB MIB I/O, EIDE FDC 25/16550) w/ECP-EPF11G \$21</p>	<p><b>Miscellaneous</b></p> <p>NEC 1.44Mb FDD \$36                  TEAC 1.24Mb FDD \$57                  4X CD-ROM IDE \$72                  8X CD-ROM IDE \$120                  Colorado Travan T1000 850Mb tape drive \$190                  3-button serial mouse \$10                  SplitFoot 101-key \$20</p>

Prices and availability subject to change without notice.  
**CALL FOR DAILY LOW PRICES!**

**ELECTRONIC SHOPPER**

**CABLE TV CONVERTERS**

Equipment & Accessories  
 Wholesalers Welcome  
**Call VISION TIME PRODUCTS**  
 1-800-310-1153 M-F 8a-8p  
 NO TENN SALES

**New Surveillance Devices!**

Smoke Alarm and Table Clock Video Cameras SC-600 TC-70  
 Ultra miniature video cameras hidden in smoke alarm or alarm clock - your choice. Wide field of view and super .1 lux low light sensitivity! Undetectable!  
 High quality B/W with 420 lines of resolution for ultra sharp images. Direct output of video and audio. **\$219.95 ea.**  
**Best price on surveillance cameras anywhere!**

Telephone Transmitter KB hidden in dual modular adaptor Transmits both sides of conversation to any FM radio up to 1/4 mile. "SnapKit" technology. Uses phone line for power and antennae. Goes completely unnoticed. MA-100 **\$25.95**  
 High quality cassette deck plugs directly into telephone jack! Records up to 12 hours of conversations on a single cassette. Recording starts and stops automatically when phone is used! **Visa/MC (214)266-7490**  
 Free shipping! Check/Money orders also accepted.  
**Seymour-Radix Inc. Box 166055-N Irving, TX 75016**  
 Now you can visit us on the internet at <http://www.whynet.com/sr/>

**Cable TV Descramblers**  
 Converters \* Filters \* Accessories

30 day Free Trial - NO RISK!  
 Unbeatable wholesale prices!  
 Affordable extended warranty  
 1 Year Warranty on all products

Free Catalog

Call the cable professionals!

Credit Cards Welcome!

**1-800-379-3976**

Prices starting as low as **\$99!**



# Discover DC Electronics

17-Module Course -- Only \$49.95

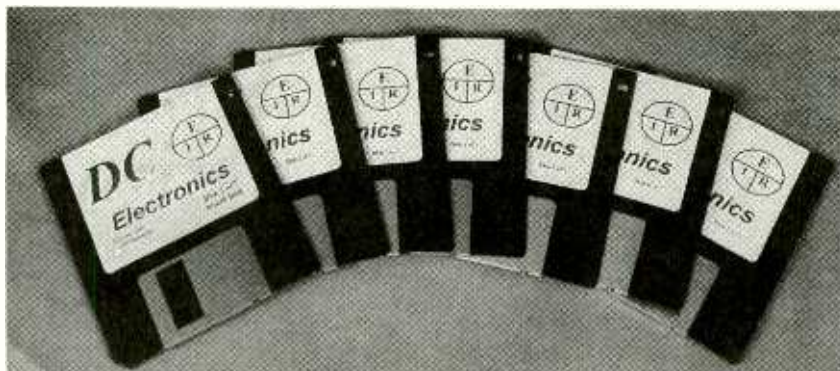

Contains everything you ever needed to know about DC electronics. Whether you are a professional working in electronics and you want a review of the basics, or a student or hobbyist new to this field and need a good self-paced course, this is the perfect way to get started.

The course starts with basics and assumes you know nothing about electronics. It teaches the required math, how to use a scientific calculator, and the metric notation system. Each module has been written by an electronics instructor, and will directly from a floppy or from a menu-driven system on your hard drive. Every module includes a review, summary, quiz, and a final exam that can be printed out. Important points are animated to make the explanation clear.

System requirements: IBM Compatible, 512K RAM, VGA Color, Hard Drive and DOS 3.2 or newer.

## Here are the Modules

- |                                 |                                |
|---------------------------------|--------------------------------|
| 1. Atoms and Electrons          | 10. Series / Parallel Circuits |
| 2. Volts / Current / Resistance | 11. Voltage Dividers           |
| 3. Numbers greater than one     | 12. Kirchhoff's Law            |
| Scientific - metric notation    | 13. Advanced DC Circuit        |
| 4. Numbers less than one        | Analysis                       |
| Scientific - metric notation    | 14. Capacitors / RC Time       |
| 5. Resistor Color Codes         | Constants                      |
| 6. Using Calculators            | 15. Introduction to Magnetism  |
| 7. Ohms Law and Power           | 16. Inductors and L/R Time     |
| 8. Series Circuits              | Constants                      |
| 9. Parallel Circuits            | 17. Volt/Ohm/Current Meters    |

Clagg Inc. P.O. Box 4099, Farmingdale, NY 11735

Send me my course, today! Charge me the special introductory price!

Name \_\_\_\_\_ \$49.95 + \$4.95 shipping

Address \_\_\_\_\_

Address \_\_\_\_\_

City \_\_\_\_\_ State \_\_\_\_\_

Zip \_\_\_\_\_

Payment Enclosed \$ \_\_\_\_\_

Check  Money Order  Credit Card

New York residents add local sales taxes. Canadians add \$6

per order. Credit card orders by phone or fax. Automated

telephone orders 516-293-3751. Fax 516-293-3115.

Allow 4 to 6 weeks for delivery.

### Credit Card Info

MC  Visa

Card # \_\_\_\_\_

Exp Date \_\_\_\_\_

Signature \_\_\_\_\_

Education?  
Retirement?  
Peace of Mind?

You have  
your reasons.



No matter what you're saving money for, U.S. Savings Bonds make sense. They're backed by the full faith and credit of the United States. They earn interest for up to 30 years. And their value is guaranteed to grow at market-based rates.

Ask your employer or banker about saving with U.S. Savings Bonds.

Or for a recorded message of current rate information, call 1-800-4US-BOND 1-800-487-2663



A public service of this magazine



# CLASSIFIED

## Pocket Cube™

Wireless cable box tester  
for authorized technicians.  
Surface Mount Technology.  
Works on J\*\*\*\*\* models  
D\*5,D\*V5,D\*7,D\*V7,D\*BB,  
C\*T,W\*R.

**Only \$59.<sup>95</sup>!**

(plus \$8 S&H)

**30 Day Warranty**

Pocket Cube with filter \$69.95+S&H

Quantity discounts available.

Dealers Welcome.

**NEW!**

**Pocket Cube Plus™**

For testing of raw boxes.

**CALL!**

Test chips available for J\*\*\*\*\* and  
SA8600.

**Order Toll Free**

**1-800-417-6689**

Mon-Fri, 9AM-5PM EST.

If busy please check trying.

VISA, MC, MO or CASHIERS CHECK

IEC, P O Box 52347, Knoxville, TN 37850-2347

Pocket Cube is a test generator ONLY.

Do not use these devices without authorization  
from your local cable company and local officials.

No TN sales.

## MISCELLANEOUS ELECTRONICS FOR SALE

**TUBES:** "oldest", "latest". Parts and schematics.  
SASE for lists. **STEINMETZ**, 7519 Maplewood  
Ave., EN 46324, Hammond, IN 46324.

**FIBER-Optic Projects** — Swing into the new  
technology by assembling tried and true projects  
recently published. "Practical Fiber-Optic Pro-  
jects" - BP374 is only \$9.95. (price includes ship-  
ping) **ELECTRONIC TECHNOLOGY TODAY  
INC.**, PO Box 240, Massapequa Park, NY  
11762-0240.

**GREEN Thumb Alert**— Electronics enters the  
Garden! New exciting book points out how gar-  
deners can build simple gadgets to promote  
success where the elements work against you.  
Some of the projects are: over/under temperature  
monitoring, dusk/dawn switching, automatic plant  
watering, warming cables, etc. "Electronic Pro-  
jects for the Garden" only \$9.95 (price includes  
shipping) **ELECTRONIC TECHNOLOGY TODAY  
INC.**, PO Box 240 Massapequa Park, NY  
11762-0240.

**TUBES**, New, up to 90% off, S.A.S.E., **KIRBY**,  
298 West Carmel Drive, Carmel, IN 46032.

**CBers** Order new CB Trick III CB book. Shows CB  
tune ups, amplifiers, and expert CB info! Send  
\$19.95 to **MEDICINE MAN CB**, PO Box 37, Clar-  
ksville, AR 72830.

**RESISTORS** 20 for \$1.00. LEDs 4 for \$1.00. Cata-  
log \$1.00. **ZIPFAST**, Box 12236, Lexington, KY  
40581-2238.

**POOR** reception on your A.M. radio? Our Signal  
Booster will help. Guaranteed! Send \$2.00 for  
details (refundable with order). **FALA ELEC-  
TRONICS**, PO Box 1376, Dept. 4, Milwaukee, WI  
53201.

**HAVE** a beeping or chirping sound with  
scrambled video on channels. We can help. Pro-  
fessional quality positive notch filters. Discounts  
on 5 or more. Fast courteous service. All credit  
cards. We now carry 1-piece cable units w/volume  
control and parental lockout for all systems. Call 1  
(800) 684-0539.

**NEW** software programs 39 different cellular  
phones! All Motorola's, Nec, Nokia, etc. Includes  
manual and cable schematics! Only \$149.95!  
Order now! **BATES**, 733 N. Wells, Chicago, IL  
60610. (312) 213-7023.

## SECURITY

**SURVEILLANCE** Privacy security protection.  
Catalog \$5.00. **SPY EMPORIUM**, 6065 Hillcroft,  
Suite 413, Houston, TX 77081. (713) 774-1000.

**PROTECT** yourself with the Security Plus  
100,000 volt Stun Gun. It's safe, effective and  
strong enough to stop any attacker. Send \$99.95  
(shipping is included) to: **F.M.C.**, PO Box 1174,  
Forest Hills, NY 11375.

## TEST EQUIPMENT

**TEST Equipment** pre-owned now at affordable  
prices. Signal generators from \$50.00, os-  
cilloscopes from \$50.00. Other equipment includ-  
ing manuals available. Send \$2.00 US for catalog.  
Refunded on first order. **J.B. Electronics**, 3446  
Dempster, Skokie, IL 60076. (847) 982-1973.

**TECHNICIANS:** Electronic component tester for  
use with oscilloscope. Satisfaction guaranteed.  
\$29.95 plus S&H. Info.: **ELECTROHM**, 529 Brent-  
wood, Lawrence, KS 66049.

**QUALITY** used test equipment for sale. Call, fax  
or write for list. **RIDGE EQUIPMENT**, PO Box 84,  
Mt. Airy, MD 21771. (301) 831-7671.

**SURPLUS** electronic test equipment for sale for  
pennies on the dollar. Request list. Phone: (908)  
722-6157. Fax: (908) 722-6391.

## BUSINESS OPPORTUNITIES

**EASY work! Excellent pay!** Assemble products  
at home. Call toll free 1 (800) 467-5566 Ext. 5192.

**FREE Invention Package:** **DAVISON & ASSO-  
CIATES** offers customized development, pat-  
enting, and licensing of new products and  
ideas. Proven results: 1 (800) 677-6382.

**PERSONAL** computer owners can earn \$1,000 to  
\$5,000 monthly using your PC. Free list of 100  
best services. **C.C.B.B.I.**, PO Box 13168, Mill  
Creek, WA 98082-1168.

**INVENTORS:** Free information booklet to inven-  
tors and developers, patent attorney in Wash-  
ington, DC area. 1 (800) 876-6670, **J.P. Halvonik**.

## EDUCATION & INSTRUCTION

**ELECTRONIC engineering.** 8 volumes com-  
plete. \$109.95. No prior knowledge required. Free  
brochure. **BANNER TECHNICAL BOOKS**, 1203  
Grant Avenue, Rockford, IL 61103.

**LEARN** VCR repair. Great profits. Home study.  
**P.C.D.I.**, Atlanta, GA. Free literature. 1 (800)  
362-7070 Dept. VRG342.

**LEARN** PC repair-troubleshooting, servicing.  
Home study. Free literature. **P.C.D.I.**, Atlanta, GA.  
1 (800) 362-7070. Dept. JG342.

**BECOME** a professional locksmith. Home study.  
Free career literature. **P.C.D.I.**, Atlanta, GA. 1  
(800) 362-7070. Dept. LKG342.

**THE Revelation of Electricity:** If you have not  
read this 23-page report, you probably do not  
really understand the basic electric circuit.  
\$15.00. Michigan residents add .90 cents sales  
tax. **REALITY PRESS**, Dept. C, Box 15756, Ann  
Arbor, MI 48106-5756.

## CABLE TV TURN-ON CHIPS

**SUPER Cable TV "Test Chips"**. Provides full  
service activation. Excellent! Instructions & il-  
lustrations. **Jerrold Starcom:** DP(V)5..DP(V)7..  
DPB7..CFT-2000 Series. **Pioneer:** BA-5000  
thru BA-6700 **Scientific Atlanta:** 8500 thru 8600.  
**Tocom:** 5503-VIP..5507. **Zenith:** ST-1000 thru  
ST-5000. **Call Now!! MASTER COMPONENTS.**  
1 (800) 233-0570.

## COMPUTER SOFTWARE

**COMPUTER Hackers Bible:** Monumental in-  
structional manual on hacking! Covers: Unix,  
password cracking, government, Packet net-  
works, DEC servers, mainframes, Wide Area  
nets, software cracking, banks, usernames, fraud,  
backdoors, AOL, spoofing, trapdoors, Com-  
puServe, shadowing, and much more! Manual  
\$22.00. **SPECTRE PRESS**, PO Box 5112-E, N.  
Muskegon, MI 49445.

**COMPUTER Viruses:** One of the largest virus  
collections in the world! Contains over 4,000 live  
viruses on disk! Includes: Jerusalem, Gotcha,  
CIA, Michaelangelo, Dark Avenger, Cancer, Era-  
sure, Rabid, USSR, Kilroy, Intruder, and more!  
\$23.00. **SPECTRE PRESS**, PO Box 5112-E, N.  
Muskegon, MI 49445.

## BUY BONDS

## SURVEILLANCE

### FM TRANSMITTERS MINI (KITS)

- \* 3-VOLT FM XMTR, up to 300 ft. indoors, 1500 ft. outdoors
- \* PHONE XMTR, range to 500 ft., uses phone-line power
- \* Sound-Activated XMTR, range to 500 ft.
- \* 2-STAGE XMTR, 9-Volt, very powerful!

All above require simple soldering at 2 to 4 places.  
\$29.95\*\* ea.

**TELE FM WIRELESS MONITORING SYSTEM.**  
(Kit) \$99.00\*

**TELE CALL FORWARDER.** Transfers incoming  
calls. \$99.00\*

**CALLER ID.** Registers incoming number.  
\$99.00\*

**TEL REGISTER WITH PRINTER.** Records dialed  
number, duration, and prints record. \$139.00\*

**12-HOUR LONG-PLAY RECORDER.** Modified  
Panasonic. Records 6 hrs. on each side of 120  
tape (supplied). Compatible with VOX and Tel  
Rec Adapter. \$119.00\*

**VOX VOICE-ACTIVATED SWITCH.** Makes re-  
corder self-activating with voices or other  
sounds. \$28.50\*\*

**TELE RECORDING ADAPTER.** Records  
incoming and outgoing calls. \$28.50\*\*

**TELEPHONE SCRAMBLERS.** Over 4,000  
separate codes. \$199.00\*

**VOICE CHANGER.** Changes man's voice to  
lady's and vice versa. \$49.00\*

For Shipping & Handling add \*\$5.00 and \*\*\$2.00 per item.  
Colo. residents add sales tax. Mail Order, VISA, M/C, COD's  
o.k. Inquire for dealer prices. Free catalog.

**MUCH, MUCH MORE — OUR 25TH YEAR!**  
**TOLL FREE 1-800-926-2488**

**A.M.C. SALES, INC.**

193 Vaquero Dr., Boulder, CO 80303

Tel: (303) 499-5405, Fax: (303) 494-4924

Mon.-Fri. 8 a.m.-5 p.m. Mtn. Time



# CLASSIFIED

## PLANS-KITS-SCHEMATICS

**CRYSTAL set Handbook** — Visit antiquity by building the radios your grandfather built. Assemble a "Quaker Oats" rig, wind coils that work and make it look like the 1920's! Only \$10.95 plus \$4.00 for shipping and handling. **CLAGGK INC.**, PO Box 4099, Farmingdale, NY 11735. US funds only! USA and Canada — no foreign orders.

**All-in-one catalog, AM/FM/ham/spy**, transmitters, amplifiers, receivers. Voice scramblers/disguisers, audio, TV, Tesla coils, plans, "secret" books, kits, imports, exports and more. Start your own licensed or unlicensed radio station, 60 full pages for \$1.00. **PAN-COM INTERNATIONAL**, PO Box 130-F06 Paradise, CA 95967.

**FREE Catalog**, 100 Leading-Edge kits. K1, PIC. Full instructions, source code. 1 (800) 875-3214. **SCIENCE FIRST**, 95 Botsford Place, Buffalo, NY 14216.

**BUILD a Hi-Tech solar flashlight**. For complete plans/photos send \$10.00 to **HUGH M. ADAMS, P.E.**, 1011-D Hondo Avenue, Fort Walton Beach, FL 32547.

## SCRAMBLING NEWS

**CABLE, satellite and DBS hacking, \$15.95. Catalog \$1.00. SCRAMBLING NEWS**, 3494 Delaware Ave., #123, Buffalo, NY, 14217-1230. Voice/FAX (716) 874-2088. <http://www.scramblingnews.com>.

## CABLE TV

**ATTN, cable box owners**. Order your ID signal and bullet stopper before it's too late. Send \$23.00 to **R.R. ENTERPRISE**, Box 3532, Easton, PA 18043.

**SECRET Cable Descramblers** Build your own descrambler for Less than \$12.00 in **seven easy steps!** Radio Shack parts list and Free descrambling methods that cost nothing to try, included. Send \$10.00 to: **INFORMATION FACTORY**, PO Box 669, Seabrook, TX 77586. For VISA/MC, COD's, (713) 922-3512 Anytime!

**DESCRAMBLE Cable** with simple circuit added to Radio Shack RF modulator and using VCR as tuner. Instructions \$10.00. **TELECOM**, Box 832 E6, Brusly, LA 70719.

**CABLE Descrambling New secret manual**. Build your own descramblers for cable and subscription TV. Instructions, schematics for SSAVI, Gated Sync, Sinewave, (HBO, Cinemax, Showtime, UHF, Adult) \$12.95, \$2 postage. **CABLETRONICS**, Box 30502R, Bethesda, MD 20824.

**CABLE TV Equipment & Accessories** Wholesalers welcome! 30 day moneyback guarantee! Free catalog! **PERFORMANCE ELECTRONICS INC.**, 1 (800) 815-1512.

**CABLE descrambler!** Build with 7 Radio Shack parts costing \$12. Instructions. \$8. F.A.S.T., Box 369-E6, Ft. Salerno, FL 34992-0369.

**CABLE TV Test Chips** for Jerrold, Teecom, Pioneer Scientific Atlanta, etc... **Quick installation!** New Multi-Mode modules available. Prices from \$5.00 each. 1 (800) 786-9025.

**CABLE-safe**. Guarantee cable privacy. The one-way valve for your cable TV signal. Cable signals come in, but they don't go out! \$29.95 + \$3.00 S&H. VISA/MC/AMEX. **ELECTROMAN**, Box 24474, New Orleans, LA 70184. (504) 482-3017.

**"DESCRAMBLER Schematics Revealed"** A powerful guide to descrambling schemes. \$10.00. VISA/MC/AMEX. **ELECTROMAN**, Box 24474, New Orleans, LA 70184. (504) 482-3017.

**UNIVERSAL Descrambler**. Unscramble signals using your VCR as the tuner. Works with virtually any system, this is the only one you need. Declare cable box independence! Fully assembled. \$129.95 + \$5.00 S&H. VISA/MC/AMEX. **ELECTROMAN**, box 24474, New Orleans, LA 70184. (504) 482-3017.

**"BULLET Buster"**. Protect your cable box against the infamous cable "bullet". The "Bullet" Buster acts as an electronic shield. Installs in-line in seconds. Don't wait until it's too late! \$19.95 + \$3.00 S&H. VISA/MC/AMEX. **ELECTROMAN**, Box 24474, New Orleans, LA 70184. (504) 482-3017.

**CABLE Unscrambled**. Everything you want to know about cable, but are afraid to ask. \$10.00. VISA/MC/AMEX. **ELECTROMAN**, Box 24474, New Orleans, LA 70184. (504) 482-3017.

**CABLE Descrambler!** Anyone can build in **seven steps** with **Radio Shack** parts. Plans \$5.00. 1 (800) 818-9103.

**CABLE Descrambler Kit**. Simple to build. connects in seconds. Instructions and **Universal Kit** for all systems. \$19.95. 1 (800) 522-8053.

**CABLE filter**, build your own- plans, parts, PC board, case, \$11.00. **VIDEO MEDIA**, Box 97-0408, Coconut Creek, FL 33097. 1 (954) 752-9202.

**CABLE TV Bullet Terminator and I.D. Blocker**. Electronically shields yourself and your box. Factory direct. Lifetime Guarantee \$14.95 1 (800) 820-9024.

**CABLE TV notch filters**. Tunable from 50 to 300 Mhz (channels 0 thru 36). Eight different models available so specify frequency or channel number when ordering. \$30.00 each plus \$3.50 S/H per order. Large quantity discounts. Call or fax **STAR CIRCUITS** at 1 (800) 433-6319 to request our free brochure or place an order.

**CABLE test chips**. Puts cable box into full service mode! Master files all models, remotes, tools. (909) 986-0971.

## SATELLITE EQUIPMENT

**FREE Big dish catalog** — Lowest prices, systems, upgrades, parts, tune-up kits, accessories, factory fresh and warranties, satisfaction guaranteed. **SKYVISION®**, 1012 Frontier Drive, Fergus Falls, MN 56537. 1 (800) 334-6455. Fax (218) 739-4879. See full page ad The Shopper Section.

**NEW 18" Digital System** — Save 30 - 60% on programming compared to other guys little dish. Introducing the new **DISH Network™** from **SKYVISION®**, 1012 Frontier Drive, Fergus Falls, MN 56537. 1(800) 500-9264. Fax (218) 739-4879. See full page ad The Shopper Section.

**VIDEOCYPER II** descrambling manual. Schematics, video and audio. Explains DES, EPROM, CloneMaster, Pay-per-view (HBO, Cinemax, Showtime, Adult, etc.) \$16.95, \$2.00 postage. Schematics for Videocypher II Plus, \$20.00. Schematics for Videocypher II 032, \$15.00. Software to copy and alter EPROM codes, \$25.00. VCII Plus EPROM, binary and source code, \$30.00. **CABLETRONICS**, Box 30502R, Bethesda, MD 20824.

**OBTAINING sound** for your VCII and VCII Plus is easy. No codes needed. Details 1 (800) 211-5635.

## Trees Make a World of Difference™

Support Tree City USA where you live. For your free booklet, write: Tree City USA, The National Arbor Day Foundation, Nebraska City, NE 68410. Let trees make a world of difference for you.

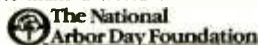

## SHOW TIME CABLE

Your Cable Connection To The Stars!

Order your **FREE** catalog today!  
**1-800-643-4258**



## STARGATE SST

- Converters & Descramblers
- All Makes & Models
- Quantity Discounts
- 30-day Money Back Guarantee
- Best Warranties

Show Time Cable  
643 N 98th St STE 260  
Omaha, NE 68114

COD • MasterCard • Visa  
Amex • Discover

## Earn \$1000

**A Week While You Learn High Paying VCR Repair.**

**Earn While You Learn . . . Secrets Revealed . . .**



### Train at Home

If you are able to work with small hand tools and possess average mechanical ability, you could earn top dollar part time or full

time. Our learn by doing method teaches you how to work on VCR's without boring unnecessary electronic basics.

**For Free Information Package Send Coupon to:**  
Foley-Belsaw Institute, 6301 Equitable Road,  
Kansas City, MO 64120

**Check VCR or another High Paying Career Field** (Check One Box Only)

VCR Repair, Dept. 62507  
 Computer Repair, Dept. 64404  
 TV/Satellite Dish, Dept. 31279  
 Computer Programming, Dept. 35227  
 Computer Specialist, Dept. 38078  
 Networking Specialist, Dept. 39065  
 Electrician, Dept. 95085

**Since 1926**

Name \_\_\_\_\_  
 Address \_\_\_\_\_  
 City \_\_\_\_\_  
 State \_\_\_\_\_ Zip \_\_\_\_\_

CIRCLE 331 ON FREE INFORMATION CARD

## ADVERTISING INDEX

Electronics Now does not assume any responsibility for errors that may appear in the index below.

Free Information Number	Page	Free Information Number	Page		
—	A&A Engineering	119	—	Information Unlimited	14
—	Advance Circuit Design	106	126	Interactive Image Tech.	CV4
214	All Electronics	91	—	Jameco	7
—	All Phase Video Security	119	—	JDR Microdevices	116
—	Allison Technology	104	—	Learn Inc.	1
—	Allstar Electronics	115	179	LG Precision	22
—	Amaze Electronics	108	—	M-2-L Electronics	117
231	AMC Sales	124	330	Mark V Electronics	100
317	American Eagle Publications	115	327	MCM Electronics	97
334	Basic Electrical Supply	106	—	Meredith Instruments	114
—	Baylin Publications	117	—	Merrimack Valley	104
—	BC Electronics	114	128	Micro Code Eng.	15
335	Beige Bag	101	329	Mouser Electronics	111
297	Bel-Merit	114	—	MWK Industries	116
280	Black Feather	90	—	National Cable Brokers	117
336	Brigar Electronics	94	257	Needham Electronics	108
—	Bsoft Software, Inc.	104	258	New Sensor Corp.	92
215	Butterworth Heinemann	105	—	NRI Schools	53
218	C&S Sales	112	71	NTE Electronics, Inc.	CV3
332	Capital Electronics	111	262	Parts Express Inc.	109
333	Circuit Specialists	102	—	PM Electronics	118
—	Cleveland Inst. of Electronics	19	328	Prairie Digital	116
—	Command Productions	96	264	Print (Pace)	99
226	Consumertronics	96	78	Radio Shack	5
58	Cook's Institute	14	—	RC Distributing Co.	119
—	DC Electronics	122	—	RF Parts	108
—	D.A.T.A. Business Publishing	29	—	Show-Time	125
326	EIA	110	—	Sil Walker	117
—	Electronics Tech Today	76, 89	270	Skyvision Inc.	95
—	Emac Inc.	111	232	Square I Electronics	119
121	Fluke Corporation	CV2	—	Super Circuits	118
331	Foley-Belsaw Co.	125	—	Tab Books	25, 34
219	Fotronic	107	—	Tektronix, Inc.	13
—	General Device Instruments	115	275	Timeline	98
—	Get-Tech	106	—	U.S. Cyberlab	118
122	Global Specialties	8	—	Visual Communications	29
—	Grantham College	11	98	Wavetek Corp.	21
—	Halcyon Group	101	211	Weka Publishing	123
—	Home Automation	117	—	World College (Div. of C.I.E.)	23
—	Home Controls	119	—	WPT Publications	115
—	IEC	124	279	Xandi Electronics	110

## ADVERTISING SALES OFFICES

**Gernsback Publications, Inc.**  
**500 Bi-County Blvd.**  
**Farmingdale, NY 11735-3931**  
**1-(516) 293-3000**  
**Fax 1-(516) 293-3115**

**Larry Steckler**  
 publisher (ext. 201)

**Christina Estrada**  
 assistant to the publisher (ext. 209)

**Arline Fishman**  
 advertising director (ext. 206)

**Michele Torrillo**  
 advertising assistant (ext. 211)

**Adria Coren**  
 credit manager (ext. 208)

### For Advertising ONLY

#### EAST/SOUTHEAST

**Stanley Levitan**  
 Eastern Advertising  
 1 Overlook Ave.  
 Great Neck, NY 11021-3750  
 1-516-487-9357  
 Fax 1-516-487-8402

#### MIDWEST/Texas/Arkansas/Okla.

**Ralph Bergen**  
 Midwest Advertising  
 One Northfield Plaza, Suite 300  
 Northfield, IL 60093-1214  
 1-847-559-0555  
 Fax 1-847-559-0562

#### PACIFIC COAST

**Blake Murphy**  
 Pacific Advertising  
 Hutch Looney & Associates, Inc.  
 6310 San Vicente Blvd.  
 Suite 360  
 Los Angeles, CA 90048-5426  
 1-213-931-3444 (ext. 224)  
 Fax 1-213-931-7309

#### Electronic Shopper

**Joe Shere**  
 National Representative  
 P.O. Box 169  
 Idyllwild, CA 92549-0169  
 1-909-659-9743  
 Fax 1-909-659-2469

#### Megan Mitchell

National Representative  
 1201 N. Rainbow Blvd., #50  
 Las Vegas, NV 89108  
 1-702-259-7043  
 Fax 1-702-259-7043

#### Subscriber Customer Service

1-800-288-0652  
 7:00 AM - 6:00 PM M-F MST

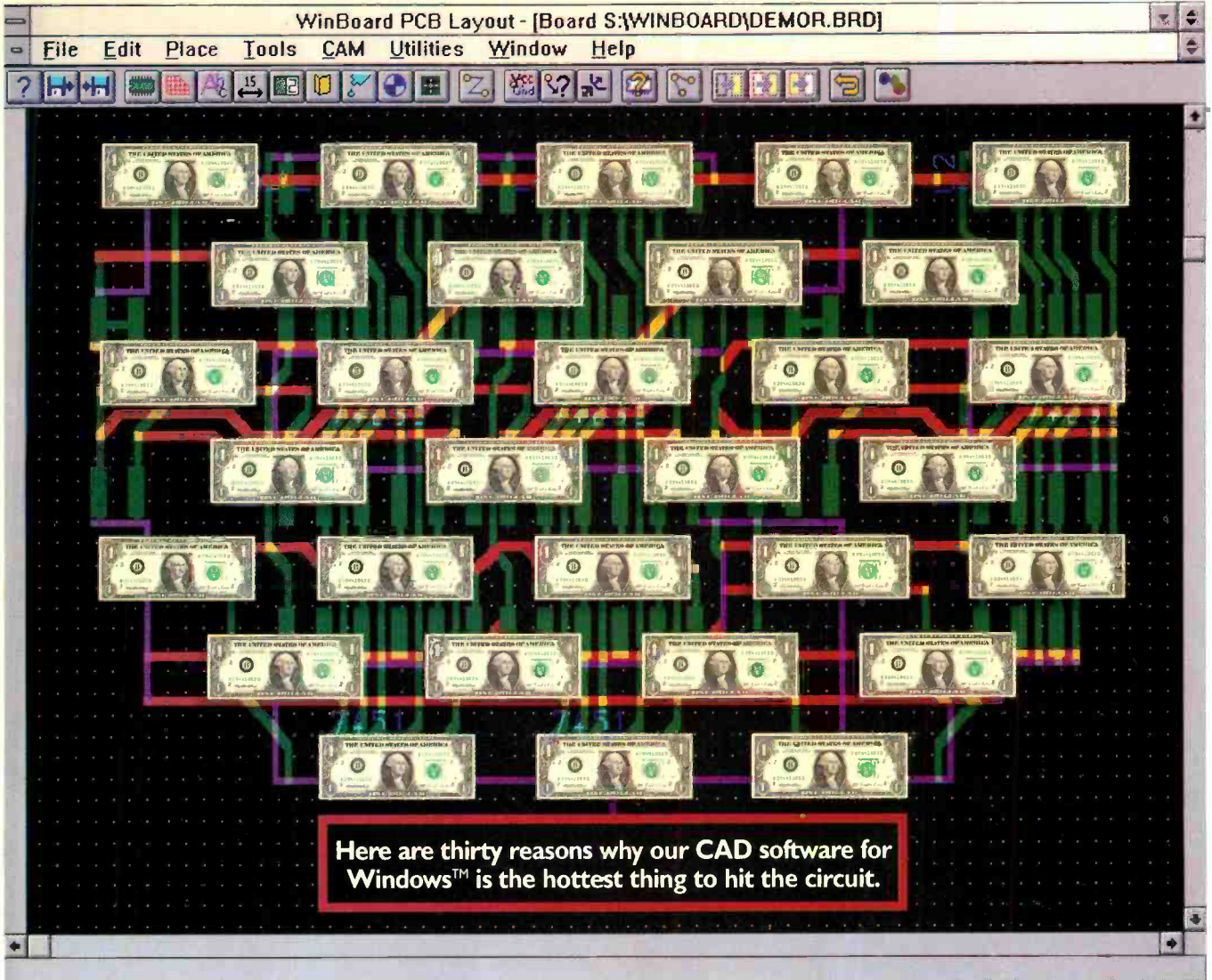

**At \$29.95, you can make a change for the better with WinBoard™ or WinDraft® (and get some change in your pocket).**

You could pay up to ten times more for many of the same features and functions that you get with **WinBoard 2.0** or **WinDraft** for less than \$30. Both offer the Windows™-friendly capabilities you need and the familiar Windows "look" you know and love. This includes easy-to-use graphical interfaces, toolbars, click-and-drag and TrueType™ fonts.

**Make sophisticated PCB design simply affordable.**

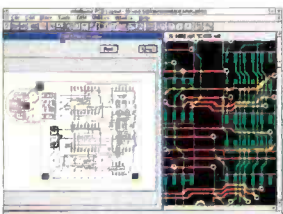

Need complex board tools on a tight budget? WinBoard 2.0 has everything you need for high-speed circuits, analog designs and dense SMT boards. Add in point-and-click editing, powerful copper pour, routing and a library of over 700 module footprints—plus a graphical editor for custom jobs—and you can see why WinBoard 2.0 is so hot.

**Breeze through schematic design with WinDraft.**

WinDraft is the ideal front-end complement to WinBoard 2.0. In just minutes, WinDraft can turn your PC into an electronic drafting table. You can do it all—from wiring and drawing to printing and finishing. And WinDraft makes your life even easier with a full graphical library editor, Bill of Materials (BOM), a clean-up tool and on-line help for troubleshooting.



**WinBoard or WinDraft. Either way, you win big.**

Get everything you need to complete your circuit designs on time and in budget. For more details on WinBoard 2.0 and/or WinDraft, or the name of your local NTE distributor, call **1-800-683-6837.**



**NTE ELECTRONICS, INC.**  
**ACTION, NOT EMPTY PROMISES**  
 CIRCLE 71 ON FREE INFORMATION CARD

# Better Designs -Faster

## Guaranteed with Electronics Workbench!

Just click and drag to create and edit schematics. Mix analog and digital devices in any combination with full control over values, models and behavior. Try 'what if' scenarios and fine tune effortlessly. And on-screen waveforms always match actual circuit response. You'll create better designs faster—*Guaranteed!*

### Guaranteed Satisfaction

Join over 40,000 customers and experience the power, flexibility and value that only Electronics Workbench offers. Receive unequalled service and free, unlimited technical support by phone, fax, e-mail, WWW, CompuServe and BBS. You'll be delighted. *We guarantee it.\**

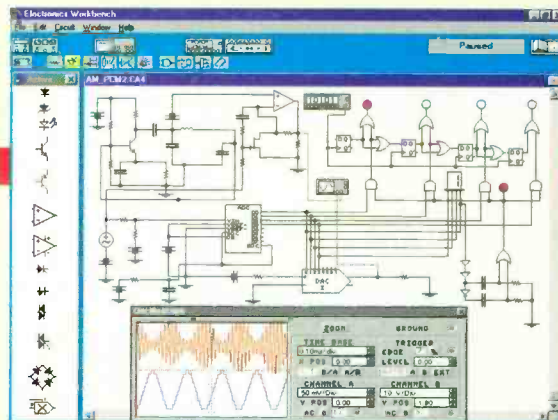
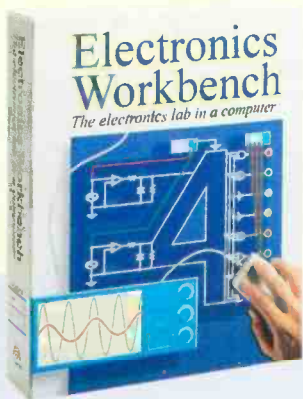

### True Mixed-Mode Power

Connect any analog or digital device to any other device without limit. Only Electronics Workbench offers this professional power for under \$2,000.

### Real-World Digital

Real-world TTL and CMOS, complete with propagation delays and fanout. Unique at this price.

### 32-Bit Speed

Integrated SPICE analog and native-mode digital simulation in full 32-bit. Unique at this price.

### Real-World Results

Unlimited supply of over 200 components and ICs and 350 real-world models—all perform as real devices.

## Electronics Workbench®

# \$299

### \*30-DAY MONEY-BACK GUARANTEE

VERSION 4.1 FOR WINDOWS 95/NT/3.1, DOS AND MACINTOSH.

Ask about our Engineer's Pack with thousands of additional models and more. Version 4.0 users call for your free upgrade.

# 800-263-5552



Fax: 416-977-1818 Internet: <http://www.interactiv.com>  
CompuServe: 71333,3435/BBS: 416-977-3540/E-mail: [ewb@interactiv.com](mailto:ewb@interactiv.com)

INTERACTIVE IMAGE TECHNOLOGIES LTD., 908 Niagara Falls Boulevard, #068, North Tonawanda, New York 14120-2060/Telephone 416-977-5550  
TRADEMARKS ARE PROPERTY OF THEIR RESPECTIVE HOLDERS. OFFER IS IN U.S. DOLLARS AND VALID ONLY IN THE UNITED STATES AND CANADA. ALL ORDERS SUBJECT TO \$15 SHIPPING AND HANDLING CHARGE

Australia: 2-519-3933 • Belgium: 2-384-7309 • Brazil: 11-453-5588 • Chile: 2-236-0300 • Cyprus: 2-62-1048 • Czech Republic: 42-48-23454 • Denmark: 33-25-0109 • Finland: 0-297-5033 • France: 14-908-9000 • Germany: 711-62-7740 • Greece: 1-524-9981 • Hungary: 1-215-0082  
India: 11-578-7055 • Indonesia: 21-470-0815 • Israel: 3-647-5613 • Italy: 11-437-5549 • Japan: 3-3382-3136 • Malaysia: 3-774-2189 • Mexico: 5-593-5260 • Netherlands: 18031-7666 • New Zealand: 9-267-1756 • Norway: 22-16-70-45 • Philippines: 973-27-0118  
Portugal: 1-81-46609 • Singapore: 777-2303 • Slovenia: 61-317-830 • South Africa: 331-6-8309 • South Korea: 2-2-222-3431 • Spain: 1-383-8335 • Sweden: 8-740-5500 • Taiwan: 886-2-366-0080 • Thailand: 66-2-398-6952 • UAE: 4-453505 • UK: 203-23-3216

CIRCLE 126 ON FREE INFORMATION CARD